

User reference guide

Daikin Altherma 3 R MT F

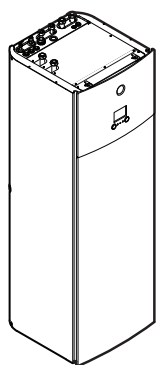

Download the
ONECTA app

 **STAND BY ME**
Discover our service offer

ELVZ12S18E▲6V▼
ELVZ12S23E▲6V▼

ELVZ12S18E▲9W▼
ELVZ12S23E▲9W▼

▲ = 1, 2, 3, ..., 9, A, B, C, ..., Z
▼ = , 1, 2, 3, ..., 9

Table of contents

1	About this document	4
1.1	Meaning of warnings and symbols	5
2	User safety instructions	7
2.1	General	7
2.2	Instructions for safe operation	8
3	About the system	10
3.1	Components in a typical system layout	10
4	Quick guide	11
4.1	User permission level	11
4.2	Space heating/cooling	11
4.3	Domestic hot water	15
5	Operation	16
5.1	User interface: Overview	16
5.2	Menu structure: Overview user settings	18
5.3	Possible screens: Overview	19
5.3.1	Home screen	19
5.3.2	Main menu screen	22
5.3.3	Setpoint screen	23
5.3.4	Detailed screen with values	24
5.4	Turning operation ON or OFF	24
5.4.1	Visual indication	24
5.4.2	To turn ON or OFF	25
5.5	Reading out information	25
5.6	Space heating/cooling control	26
5.6.1	About space heating/cooling control	26
5.6.2	Setting the space operation mode	26
5.6.3	Determining which temperature control you are using	28
5.6.4	To change the desired room temperature	28
5.6.5	To change the desired leaving water temperature	29
5.7	Domestic hot water control	30
5.7.1	About domestic hot water control	30
5.7.2	Reheat mode	31
5.7.3	Scheduled mode	32
5.7.4	Scheduled + reheat mode	32
5.7.5	To change the domestic hot water temperature	33
5.7.6	Using DHW powerful operation	33
5.8	Preset values and schedules	34
5.8.1	Using preset values	34
5.8.2	Using and programming schedules	34
5.8.3	Schedule screen: Example	37
5.8.4	Setting the energy prices	41
5.9	Weather-dependent curve	43
5.9.1	What is a weather-dependent curve?	43
5.9.2	2-points curve	44
5.9.3	Slope-offset curve	45
5.9.4	Using weather-dependent curves	46
5.10	Other functionalities	48
5.10.1	To configure time and date	48
5.10.2	Using quiet mode	49
5.10.3	Using holiday mode	49
5.10.4	Using WLAN	50
6	Energy saving tips	53
7	Maintenance and service	54
7.1	Overview: Maintenance and service	54
8	Troubleshooting	56
8.1	To display the help text in case of a malfunction	56
8.2	To check the malfunction history	56
8.3	Symptom: You are feeling too cold (hot) in your living room	57
8.4	Symptom: The water at the tap is too cold	57
8.5	Symptom: Heat pump failure	58

8.6	Symptom: The system is making gurgling noises after commissioning.....	58
9	Relocation	60
9.1	Overview: Relocation.....	60
10	Disposal	61
11	Glossary	62
12	Installer settings: Tables to be filled in by installer	63
12.1	Configuration wizard.....	63
12.2	Settings menu	64

1 About this document



INFORMATION

This unit is a heating only model. Therefore, all references to cooling in this document are NOT applicable.

Thank you for purchasing this product. Please:

- Read the documentation carefully before operating the user interface to ensure the best possible performance.
- Request the installer to inform you about the settings that he used to configure your system. Check if he has filled in the installer settings tables. If NOT, request him to do so.
- Keep the documentation for future reference.

Target audience

End users

Documentation set

This document is part of a documentation set. The complete set consists of:

- **General safety precautions:**
 - Safety instructions that you must read before installing
 - Format: Paper (in the box of the indoor unit)
- **Operation manual:**
 - Quick guide for basic usage
 - Format: Paper (in the box of the indoor unit)
- **User reference guide:**
 - Detailed step-by-step instructions and background information for basic and advanced usage
 - Format: Digital files on <https://www.daikin.eu>. Use the search function 🔍 to find your model.
- **Installation manual – Outdoor unit:**
 - Installation instructions
 - Format: Paper (in the box of the outdoor unit)
- **Installation manual – Indoor unit:**
 - Installation instructions
 - Format: Paper (in the box of the indoor unit)
- **Installer reference guide:**
 - Preparation of the installation, good practices, reference data, ...
 - Format: Digital files on <https://www.daikin.eu>. Use the search function 🔍 to find your model.
- **Addendum book for optional equipment:**
 - Additional info about how to install optional equipment
 - Format: Paper (in the box of the indoor unit) + Digital files on <https://www.daikin.eu>. Use the search function 🔍 to find your model.

Latest revisions of the supplied documentation may be available on the regional Daikin website or via your installer.

The original instructions are written in English. All other languages are translations of the original instructions.

ONECTA app



If set up by your installer, you can use the ONECTA app to control and monitor the status of your system. For more information, see:

<http://www.onlinecontroller.daikineurope.com/>



Breadcrumbs

Breadcrumbs (example: **[4.3]**) help you to locate where you are in the menu structure of the user interface.

1	To enable the breadcrumbs: In the home screen or main menu screen, press the help button. The breadcrumbs appear in the top left corner of the screen.	?
2	To disable the breadcrumbs: Press the help button again.	?

This document also mentions these breadcrumbs. **Example:**

1	Go to [4.3]: Space heating/cooling > Operation range .	
----------	--	--

This means:









1	Starting from the home screen, turn the left dial and go to Space heating/cooling .	
2	Press the left dial to enter the submenu.	
3	Turn the left dial and go to Operation range .	
4	Press the left dial to enter the submenu.	

1.1 Meaning of warnings and symbols







DANGER



Indicates a situation that results in death or serious injury.

	DANGER: RISK OF ELECTROCUTION Indicates a situation that could result in electrocution.
	DANGER: RISK OF BURNING/SCALDING Indicates a situation that could result in burning/scalding because of extreme hot or cold temperatures.
	DANGER: RISK OF EXPLOSION Indicates a situation that could result in explosion.
	WARNING Indicates a situation that could result in death or serious injury.
	WARNING: FLAMMABLE MATERIAL
	CAUTION Indicates a situation that could result in minor or moderate injury.
	NOTICE Indicates a situation that could result in equipment or property damage.
	INFORMATION Indicates useful tips or additional information.

Symbols used on the unit:

Symbol	Explanation
	Before installation, read the installation and operation manual, and the wiring instruction sheet.
	Before performing maintenance and service tasks, read the service manual.
	For more information, see the installer and user reference guide.
	The unit contains rotating parts. Be careful when servicing or inspecting the unit.

Symbols used in the documentation:

Symbol	Explanation
	Indicates a figure title or a reference to it. Example: "▲ 1-3 Figure title" means "Figure 3 in chapter 1".
	Indicates a table title or a reference to it. Example: "■ 1-3 Table title" means "Table 3 in chapter 1".

2 User safety instructions

Always observe the following safety instructions and regulations.

2.1 General



WARNING

If you are NOT sure how to operate the unit, contact your installer.



WARNING

This appliance can be used by children aged from 8 years and above and persons with reduced physical, sensory or mental capabilities or lack of experience and knowledge if they have been given supervision or instruction concerning use of the appliance in a safe way and understand the hazards involved.

Children SHALL NOT play with the appliance.

Cleaning and user maintenance SHALL NOT be made by children without supervision.



WARNING

To prevent electrical shocks or fire:

- Do NOT rinse the unit.
- Do NOT operate the unit with wet hands.
- Do NOT place any objects containing water on the unit.



CAUTION

- Do NOT place any objects or equipment on top of the unit.
- Do NOT sit, climb or stand on the unit.

- Units are marked with the following symbol:



This means that electrical and electronic products may NOT be mixed with unsorted household waste. Do NOT try to dismantle the system yourself: dismantling the system, treatment of the refrigerant, of oil and of other parts MUST be done by an authorised installer and MUST comply with applicable legislation.

Units MUST be treated at a specialised treatment facility for reuse, recycling and recovery. By ensuring this product is disposed of correctly, you will help to prevent potential negative consequences for the environment and human health. For more information, contact your installer or local authority.

- Batteries are marked with the following symbol:



This means that the batteries may NOT be mixed with unsorted household waste. If a chemical symbol is printed beneath the symbol, this chemical symbol means that the battery contains a heavy metal above a certain concentration.

Possible chemical symbols are: Pb: lead (>0.004%).

Waste batteries MUST be treated at a specialised treatment facility for reuse. By ensuring waste batteries are disposed of correctly, you will help to prevent potential negative consequences for the environment and human health.

2.2 Instructions for safe operation



WARNING: MILDLY FLAMMABLE MATERIAL

The refrigerant inside this unit is mildly flammable.



WARNING

The appliance shall be stored so as to prevent mechanical damage and in a well-ventilated room without continuously operating ignition sources (example: open flames, an operating gas appliance or an operating electric heater).





WARNING

- Do NOT pierce or burn refrigerant cycle parts.
- Do NOT use cleaning materials or means to accelerate the defrosting process other than those recommended by the manufacturer.
- Be aware that the refrigerant inside the system is odourless.

**WARNING**

- The refrigerant inside the unit is mildly flammable, but normally does NOT leak. If the refrigerant leaks in the room and comes in contact with fire from a burner, a heater, or a cooker, this may result in fire, or the formation of a harmful gas.
- Turn OFF any combustible heating devices, ventilate the room, and contact the dealer where you purchased the unit.
- Do NOT use the unit until a service person confirms that the part from which the refrigerant leaked has been repaired.

**WARNING**

Air purging heat emitters or collectors. Before you purge air from heat emitters or collectors, check if  or  is displayed on the home screen of the user interface.

- If not, you can purge air immediately.
- If yes, make sure that the room where you want to purge air is sufficiently ventilated. **Reason:** Refrigerant might leak into the water circuit, and subsequently into the room when you purge air from the heat emitters or collectors.

3 About the system

Depending on the system layout, the system can:

- Heat up a space
- Cool down a space
- Produce domestic hot water



INFORMATION

This unit is a heating only model. Therefore, all references to cooling in this document are NOT applicable.



INFORMATION

If underfloor heating is installed in the main zone, then in cooling mode the main zone can only provide refreshment. Real cooling is then NOT allowed.

3.1 Components in a typical system layout

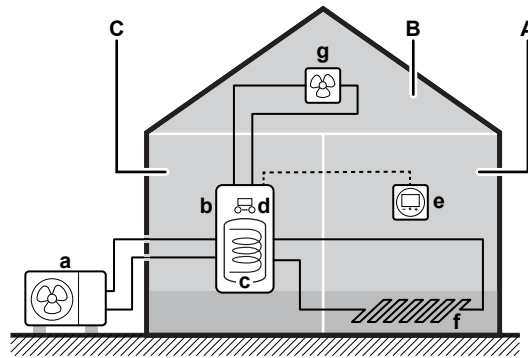

- A** Main zone. **Example:** Living room.
- B** Additional zone. **Example:** Bedroom.
- C** Technical room. **Example:** Garage.
- a** Outdoor unit heat pump
- b** Indoor unit heat pump
- c** Domestic hot water (DHW) tank
- d** User interface of the indoor unit
- e** Dedicated Human Comfort Interface (BRC1HHDA used as room thermostat)
- f** Underfloor heating
- g** Radiators, heat pump convectors, or fan coil units





4 Quick guide

4.1 User permission level

The amount of information you can read and edit in the menu structure depends on your user permission level:

- **User:** Standard mode
- **Advanced user:** You can read and edit more information

To change the user permission level

1	Go to [B]: User profile. 	
2	Enter the applicable pin code for the user permission level. <ul style="list-style-type: none"> ▪ Browse through the list of digits and change the selected digit. ▪ Move the cursor from left to right. ▪ Confirm the pin code and proceed. 	<p>—</p> <p></p> <p></p> <p></p>

User pin code

The **User** pin code is **0000**.

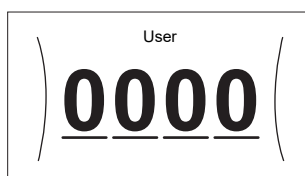

Advanced user pin code

The **Advanced user** pin code is **1234**. Additional menu items for the user are now visible.

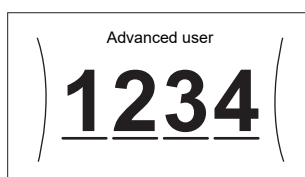



4.2 Space heating/cooling

To turn space heating/cooling operation ON or OFF





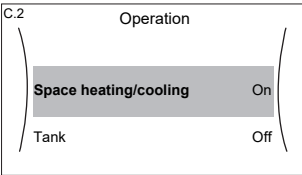

NOTICE

Room frost protection. Even if you turn OFF space heating/cooling operation ([C.2]: Operation > Space heating/cooling), room frost protection operation –if enabled– can still activate. However, for leaving water temperature control and external room thermostat control, the protection is NOT guaranteed.

<p>1</p>	<p>Go to [C.2]: Operation > Space heating/cooling.</p> 	
<p>2</p>	<p>Set operation to On or Off.</p>	

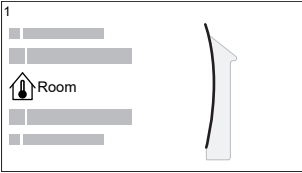

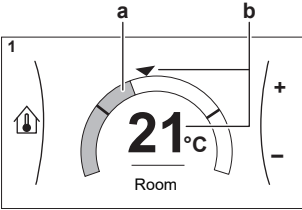
To change the desired room temperature

During room temperature control, you can use the room temperature setpoint screen to read out and adjust the desired room temperature.

<p>1</p>	<p>Go to [1]: Room.</p> 	
<p>2</p>	<p>Adjust the desired room temperature.</p>  <p>a Actual room temperature b Desired room temperature</p>	

To change the desired leaving water temperature

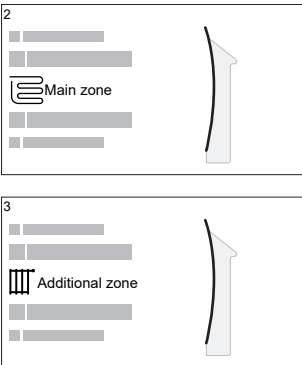
You can use the leaving water temperature setpoint screen to read out and adjust the desired leaving water temperature.

<p>1</p>	<p>Go to [2]: Main zone or [3]: Additional zone.</p> 	
-----------------	--	---

2 Adjust the desired leaving water temperature.

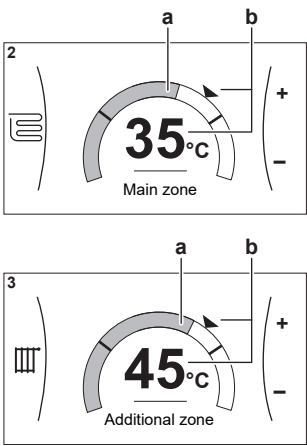

a Actual leaving water temperature
b Desired leaving water temperature

To change the weather-dependent curve for the space heating/cooling zones

1 Go to the applicable zone:

Zone	Go to ...
Main zone – Heating	[2.5] Main zone > Heating WD curve
Main zone – Cooling	[2.6] Main zone > Cooling WD curve
Additional zone – Heating	[3.5] Additional zone > Heating WD curve
Additional zone – Cooling	[3.6] Additional zone > Cooling WD curve

2 Change the weather-dependent curve.

There are 2 types of WD curves: **slope-offset curve** (default), and **2-points curve**. If needed, you can change the type in [2.E] Main zone > WD curve type. The way to adjust the curve depends on the type.

Slope-offset curve



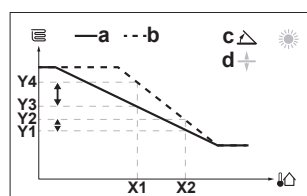

Slope. When slope is changed, the new preferred temperature at X1 is unequally higher than the preferred temperature at X2.

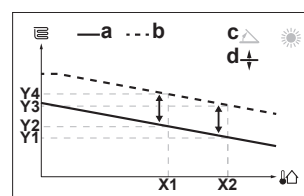

Offset. When offset is changed, the new preferred temperature at X1 is equally higher than the preferred temperature at X2.





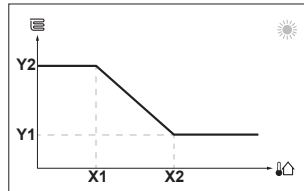

- X1, X2** Outdoor ambient temperature
- Y1~Y4** Desired leaving water temperature
- a** WD curve before changes
- b** WD curve after changes
- c** Slope
- d** Offset

Possible actions on this screen	
	Select slope or offset.
	Increase or decrease the slope/offset.
	When slope is selected: set slope and go to offset. When offset is selected: set offset.
	Confirm changes and return to the submenu.

2-points curve



X1, X2 Outdoor ambient temperature
Y1, Y2 Desired leaving water temperature

Possible actions on this screen	
	Go through the temperatures.
	Change the temperature.
	Go to the next temperature.
	Confirm changes and proceed.

More information

For more information, see also:

- ["5.4 Turning operation ON or OFF" \[▶ 24\]](#)
- ["5.6 Space heating/cooling control" \[▶ 26\]](#)
- ["5.8 Preset values and schedules" \[▶ 34\]](#)
- ["5.9 Weather-dependent curve" \[▶ 43\]](#)

4.3 Domestic hot water

To turn tank heating operation ON or OFF



NOTICE

Disinfection mode. Even if you turn OFF tank heating operation ([C.3]: **Operation** > **Tank**), disinfection mode will remain active. However, if you turn it OFF while disinfection is running, an AH error occurs.

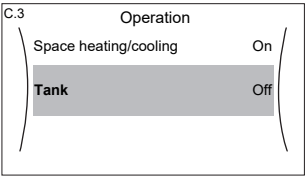
1	Go to [C.3]: Operation > Tank . 	
2	Set operation to On or Off .	

To change the tank temperature setpoint

In **Reheat only** mode, you can use the tank temperature setpoint screen to read out and adjust the domestic hot water temperature.

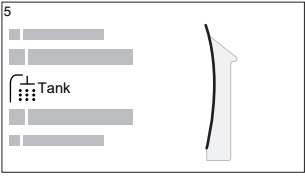
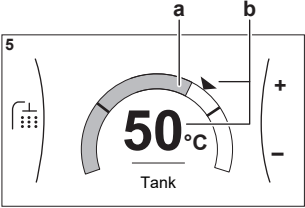
1	Go to [5]: Tank . 	
2	Adjust the domestic hot water temperature.  <p>a Actual domestic hot water temperature b Desired domestic hot water temperature</p>	

In other modes, you can only view the setpoint screen but not modify it. Instead, you can modify the settings for the **Comfort setpoint** [5.2], **Eco setpoint** [5.3] and **Reheat setpoint** [5.4].

More information

For more information, see also:

- "5.4 Turning operation ON or OFF" [▶ 24]
- "5.7 Domestic hot water control" [▶ 30]
- "5.8 Preset values and schedules" [▶ 34]

5 Operation



INFORMATION

This unit is a heating only model. Therefore, all references to cooling in this document are NOT applicable.

5.1 User interface: Overview

The user interface has the following components:

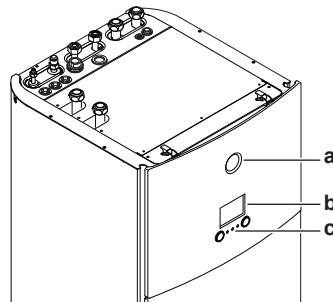

- a** Status indicator
- b** LCD screen
- c** Dials and buttons

Status indicator

The LEDs of the status indicator light up or blink to show the operating mode of the unit.

LED	Mode	Description
Blinking blue	Standby	The unit is not in operation.
Continuous blue	Operation	The unit is in operation.
Blinking red	Malfunction	A malfunction occurred. See " 8.1 To display the help text in case of a malfunction " [▶ 56] for more information.

LCD screen

The LCD screen has a sleeping function. After 15 min of non-interaction with the user interface, the screen darkens. Pressing any button or rotating any dial awakens the display.

Dials and buttons

You use the dials and buttons:

- To navigate through the screens, menus and settings of the LCD screen
- To set values

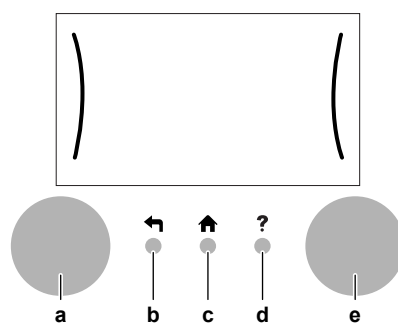

Item		Description
a	Left dial	<p>The LCD shows an arc on the left side of the display when you can use the left dial.</p> <ul style="list-style-type: none"> Turn, then press the left dial. Navigate through the menu structure. Turn the left dial. Choose a menu item. Press the left dial. Confirm your choice or go to a submenu.
b	Back button	Press to go back 1 step in the menu structure.
c	Home button	Press to go back to the home screen.
d	Help button	Press to show a help text related to the current page (if available).
e	Right dial	<p>The LCD shows an arc on the right side of the display when you can use the right dial.</p> <ul style="list-style-type: none"> Turn, then press the right dial. Change a value or setting, shown at the right side of the screen. Turn the right dial. Navigate through the possible values and settings. Press the right dial. Confirm your choice and go to the next menu item.

5.2 Menu structure: Overview user settings

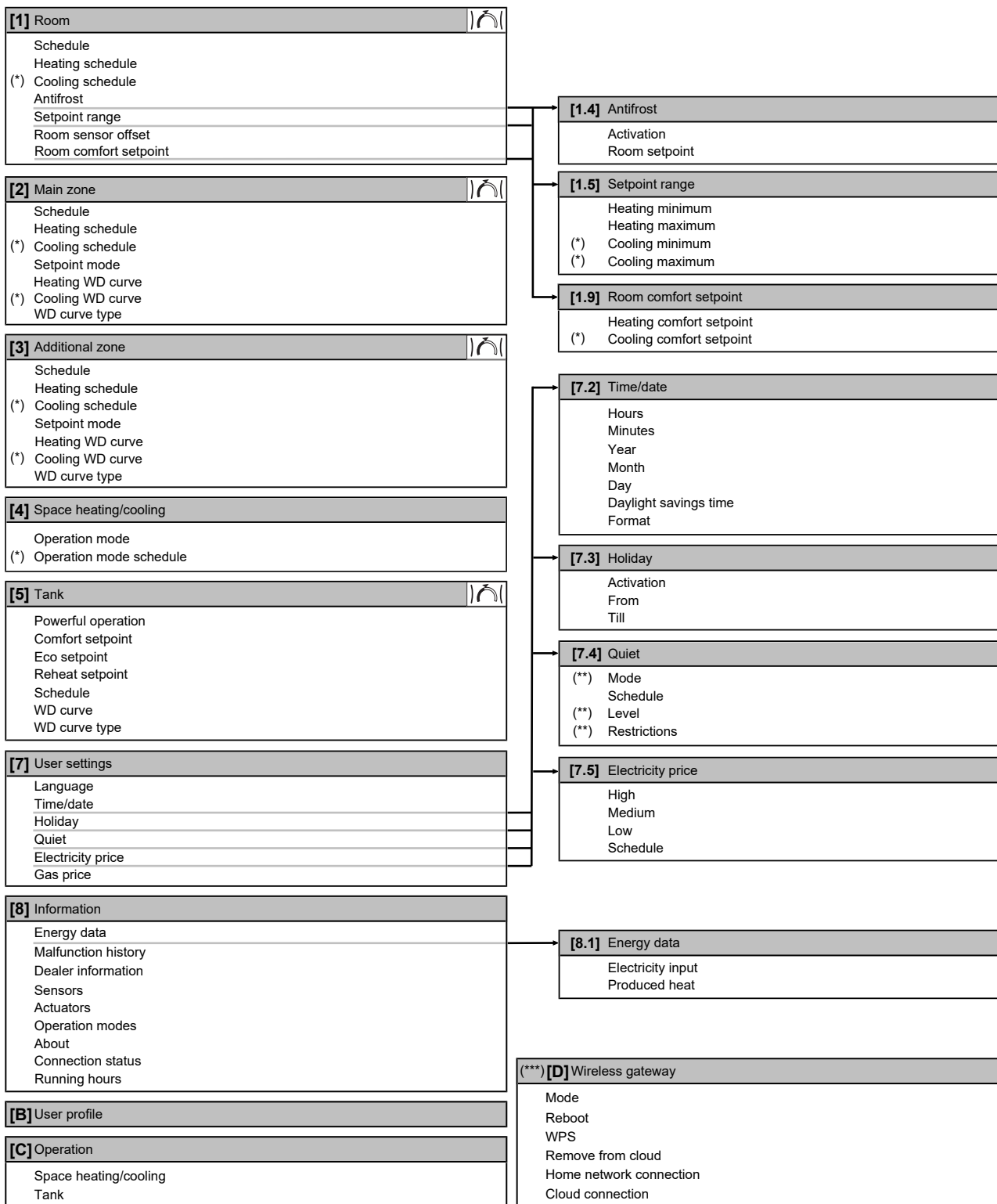

- Setpoint screen
- (*) Only applicable for models where cooling is possible
- (**) Only accessible by installer
- (***) Only applicable when WLAN is installed



INFORMATION

Depending on the selected installer settings and unit type, settings will be visible/invisible.

5.3 Possible screens: Overview

The most common screens are as follows:

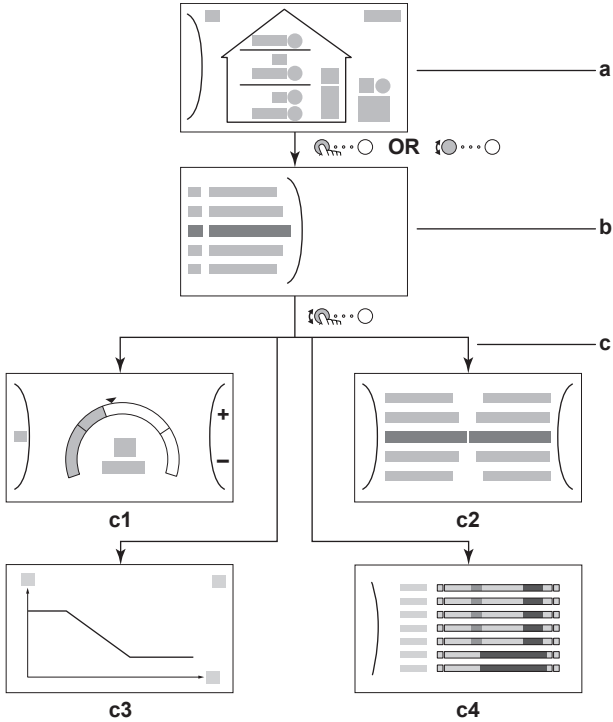







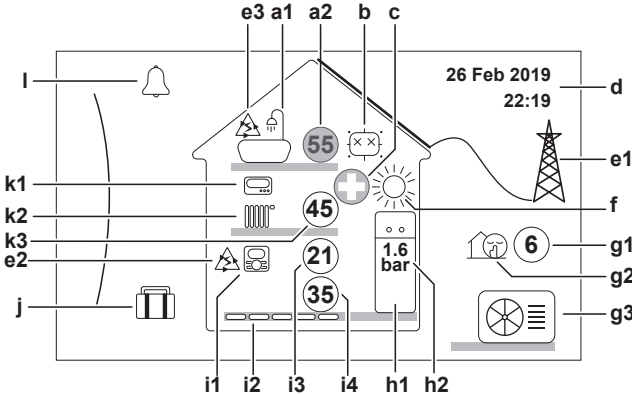









- a Home screen
- b Main menu screen
- c Lower level screens:
 - c1: Setpoint screen
 - c2: Detailed screen with values
 - c3: Screen with weather-dependent curve
 - c4: Screen with schedule















5.3.1 Home screen

Press the button to go back to the home screen. You see an overview of the unit configuration and the room and setpoint temperatures. Only symbols applicable for your configuration are visible on the home screen.



Possible actions on this screen	
	Go through the list of the main menu.
	Go to the main menu screen.
?	Enable/disable breadcrumbs.

Item		Description
a	Domestic hot water	
	a1	 Domestic hot water
	a2	 Measured tank temperature ^(a)
b	Disinfection / Powerful	
		Disinfection mode active
		Powerful operation mode active
c	Emergency	
		Heat pump failure and system operates in Emergency mode or heat pump is forced off.
d	Current date and time	
e	Smart energy	
	e1	 Smart energy is available via solar panels or smart grid.
	e2	 Smart energy is currently being used for space heating.
	e3	 Smart energy is currently being used for domestic hot water.
f	Space operation mode	
		Cooling
		Heating
g	Outdoor / quiet mode	
	g1	 Measured outdoor temperature ^(a)
	g2	 Quiet mode active
	g3	 Outdoor unit
h	Indoor unit / domestic hot water tank	
	h1	 Floor-standing indoor unit with integrated tank
		 Wall-mounted indoor unit
		 Wall-mounted indoor unit with separated tank
	h2	 1.6 bar Water pressure

Item	Description
i	Main zone
i1	Installed room thermostat type:
	 Unit operation is decided based on the ambient temperature of the dedicated Human Comfort Interface (BRC1HHDA used as room thermostat).
	 Unit operation is decided by the external room thermostat (wired or wireless).
	— No room thermostat installed or set. Unit operation is decided based on the leaving water temperature regardless of the actual room temperature and/or heating demand of the room.
i2	Installed heat emitter type:
	 Underfloor heating
	 Fancoil unit
	 Radiator
i3	 Measured room temperature ^(a)
i4	 Leaving water temperature setpoint ^(a)
j	Holiday mode
	 Holiday mode active
k	Additional zone
k1	Installed room thermostat type:
	 Unit operation is decided by the external room thermostat (wired or wireless).
	— No room thermostat installed or set. Unit operation is decided based on the leaving water temperature regardless of the actual room temperature and/or heating demand of the room.
k2	Installed heat emitter type:
	 Underfloor heating
	 Fancoil unit
	 Radiator
k3	 Leaving water temperature setpoint ^(a)
l	Malfunction
	 A malfunction occurred.
	 See "8.1 To display the help text in case of a malfunction" [▶ 56] for more information.

^(a) If the corresponding operation (for example: space heating) is not active, the circle is greyed out.

5.3.2 Main menu screen

Starting from the home screen, press (🔍) or turn (🔍) the left dial to open the main menu screen. From the main menu, you can access the different setpoint screens and submenus.

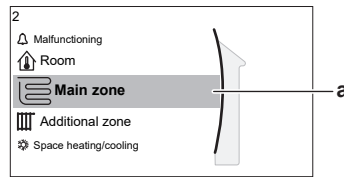

a Selected submenu

Possible actions on this screen	
🔍	Go through the list.
🔍	Enter the submenu.
?	Enable/disable breadcrumbs.

Submenu		Description
[0]	🔔 or ⚠ Malfunctioning	Restriction: Only displayed if a malfunction occurs. See "8.1 To display the help text in case of a malfunction" [▶ 56] for more information.
[1]	🏠 Room	Restriction: Only displayed if a dedicated Human Comfort Interface (BRC1HHDA used as room thermostat) is controlling the indoor unit. Set the room temperature.
[2]	📄 Main zone	Shows the applicable symbol for your main zone emitter type. Set the leaving water temperature for the main zone.
[3]	📄 Additional zone	Restriction: Only displayed if there are two leaving water temperature zones. Shows the applicable symbol for your additional zone emitter type. Set the leaving water temperature for the additional zone (if present).
[4]	☀ Space heating/cooling	Shows the applicable symbol of your unit. Put the unit in heating mode or cooling mode. You cannot change the mode on heating only models.
[5]	🚿 Tank	Set the domestic hot water tank temperature.
[7]	👤 User settings	Gives access to user settings such as holiday mode and quiet mode.
[8]	📄 Information	Displays data and information about the indoor unit.
[9]	🔧 Installer settings	Restriction: Only for the installer. Gives access to advanced settings.

Submenu		Description
[A]	Commissioning	Restriction: Only for the installer. Perform tests and maintenance.
[B]	User profile	Change the active user profile.
[C]	Operation	Turn heating/cooling functionality and domestic hot water preparation on or off.
[D]	Wireless gateway	Restriction: Only displayed if a wireless LAN (WLAN) is installed. Contains settings needed when configuring the ONECTA app.

5.3.3 Setpoint screen

The setpoint screen is displayed for screens describing system components that need a setpoint value.

Examples

[1] Room temperature screen

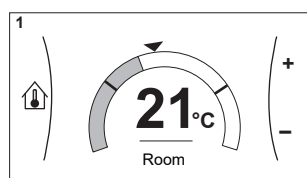

[2] Main zone screen

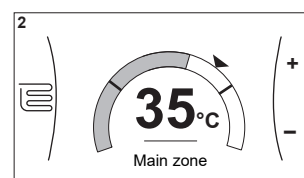

[3] Additional zone screen

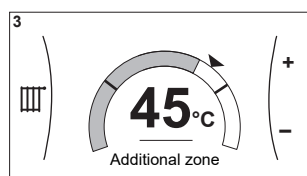

[5] Tank temperature screen

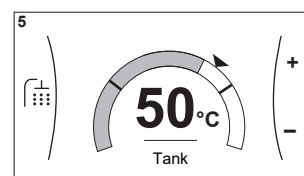

Explanation

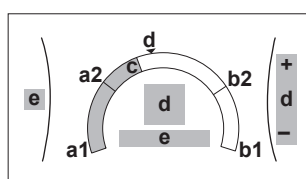

Possible actions on this screen	
	Go through the list of the submenu.
	Go to the submenu.
	Adjust and automatically apply the desired temperature.

Item	Description	
Minimum temperature limit	a1	Fixed by the unit
	a2	Restricted by the installer
Maximum temperature limit	b1	Fixed by the unit
	b2	Restricted by the installer

Item	Description	
Current temperature	c	Measured by the unit
Desired temperature	d	Turn the right dial to increase/ decrease.
Submenu	e	Turn or press the left dial to go to the submenu.

5.3.4 Detailed screen with values

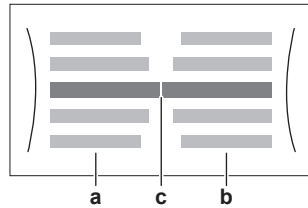

Example:

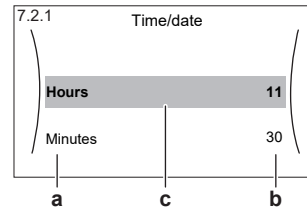

- a** Settings
- b** Values
- c** Selected setting and value

Possible actions on this screen	
	Go through the list of settings.
	Change the value.
	Go to the next setting.
	Confirm changes and proceed.

5.4 Turning operation ON or OFF

5.4.1 Visual indication

Certain functionalities of the unit can be enabled or disabled separately. If a functionality is disabled, the corresponding temperature icon in the home screen will be greyed out.

Space heating/cooling operation

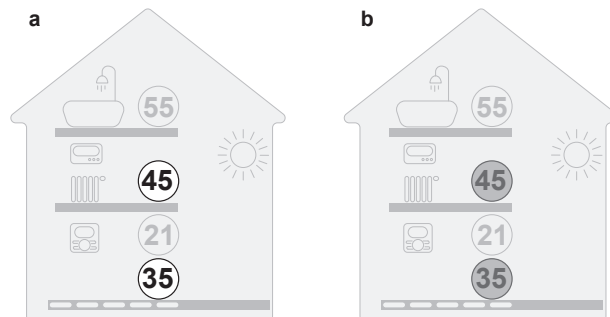

- a** Space heating/cooling operation ON
- b** Space heating/cooling operation OFF

Tank heating operation

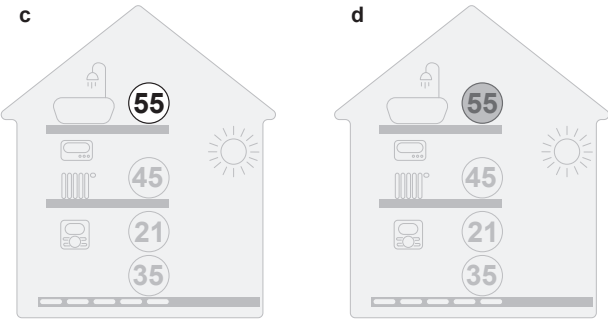

c Tank heating operation ON
d Tank heating operation OFF

5.4.2 To turn ON or OFF

Space heating/cooling operation

NOTICE
Room frost protection. Even if you turn OFF space heating/cooling operation ([C.2]: Operation > Space heating/cooling), room frost protection operation –if enabled– can still activate. However, for leaving water temperature control and external room thermostat control, the protection is NOT guaranteed.

1	Go to [C.2]: Operation > Space heating/cooling.	
2	Set operation to On or Off.	

Tank heating operation

NOTICE
Disinfection mode. Even if you turn OFF tank heating operation ([C.3]: Operation > Tank), disinfection mode will remain active. However, if you turn it OFF while disinfection is running, an AH error occurs.

1	Go to [C.3]: Operation > Tank.	
2	Set operation to On or Off.	

5.5 Reading out information

To read out information

1	Go to [8]: Information.	
----------	-------------------------	--

Possible read-out information

In menu...	You can read out...
[8.1] Energy data	Produced energy, consumed electricity, and consumed gas
[8.2] Malfunction history	Malfunction history
[8.3] Dealer information	Contact/helpdesk number
[8.4] Sensors	Room temperature, outside temperature, leaving water temperature,...
[8.5] Actuators	Status/mode of each actuator Example: Unit pump ON/OFF
[8.6] Operation modes	Current operation mode Example: Defrost/oil return mode
[8.7] About	Version information about the system
[8.8] Connection status	Information about the connection status of the unit, the room thermostat, the Lan adapter and WLAN.
[8.9] Running hours	Running hours of specific system components

5.6 Space heating/cooling control

5.6.1 About space heating/cooling control

Controlling space heating/cooling typically consists of the following stages:

- 1 Setting the space operation mode
- 2 Controlling the temperature

Depending on the system layout and installer configuration, you use a different temperature control:

- Room thermostat control
- Leaving water temperature control
- External room thermostat control

5.6.2 Setting the space operation mode

About space operation modes

Your unit can be a heating or a heating/cooling model:

- If your unit is a heating model, it can heat up a space.
- If your unit is a heating/cooling model, it can both heat up and cool down a space. You have to tell the system which operation mode to use.

To determine if a heating/cooling heat pump model is installed

1	Go to [4]: Space heating/cooling.	
----------	-----------------------------------	---

2	Check if [4.1] Operation mode is listed and editable. If so, a heating/cooling heat pump model is installed.	
----------	---	--

To tell the system which space operation to use, you can:

You can...	Location
Check which space operation mode is currently used.	Home screen
Set the space operation mode permanently.	Main menu
Restrict automatic changeover according to a monthly schedule.	

To check which space operation mode is currently used

The space operation mode is displayed on the home screen:

- When the unit is in heating mode, the icon is shown.
- When the unit is in cooling mode, the icon is shown.

The status indicator shows if the unit is currently in operation:

- When the unit is not in operation, the status indicator will show a blue pulsation with an interval of approximately 5 seconds.
- While the unit is in operation, the status indicator will light up blue constantly.

To set the space operation mode

1	Go to [4.1]: Space heating/cooling > Operation mode	
2	Select one of the following options: <ul style="list-style-type: none"> ▪ Heating: Only heating mode ▪ Cooling: Only cooling mode ▪ Automatic: The operation mode changes automatically between heating and cooling based on the outdoor temperature. Restricted per month according to the Operation mode schedule [4.2]. 	

To restrict automatic changeover according to a schedule

Conditions: You set the space operation mode to **Automatic**.

1	Go to [4.2]: Space heating/cooling > Operation mode schedule .	
2	Select a month.	
3	For each month, select an option: <ul style="list-style-type: none"> ▪ Reversible: Not restricted ▪ Heating only: Restricted ▪ Cooling only: Restricted 	
4	Confirm the changes.	

Example: Changeover restrictions

When	Restriction
During cold season. Example: October, November, December, January, February and March.	Heating only

When	Restriction
During warm season. Example: June, July and August.	Cooling only
In-between. Example: April, May and September.	Reversible

5.6.3 Determining which temperature control you are using

To determine which temperature control you are using (method 1)

Check the installer settings table filled in by the installer.

To determine which temperature control you are using (method 2)

You can see on the home screen which temperature control you are using.

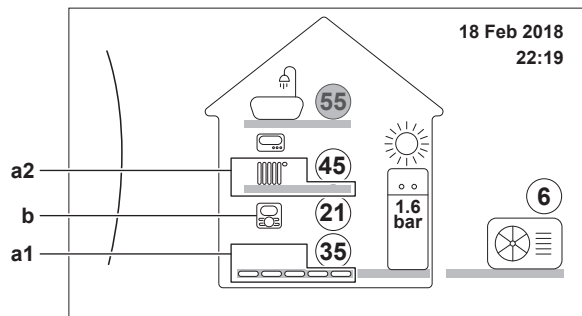

- a1** Heat emitter of the main zone (in this example **Underfloor heating**)
- a2** Heat emitter of the additional zone (in this example **Radiator**). If no icon is displayed, there is no additional zone.
- b** Room thermostat type of the main zone:

If b=...	Then the temperature control is...	
	Main zone	Additional zone (if any)
	Room thermostat control	External room thermostat control
	External room thermostat control	
No icon	Leaving water temperature control	Leaving water temperature control

5.6.4 To change the desired room temperature

During room temperature control, you can use the room temperature setpoint screen to read out and adjust the desired room temperature.

1	Go to [1]: Room. <div style="border: 1px solid black; padding: 5px; margin-top: 10px;"> </div>	
----------	--	--

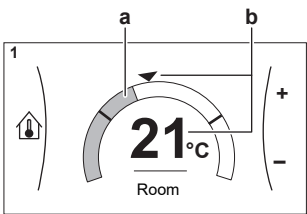
2	Adjust the desired room temperature.	○●●●●●
		
<p>a Actual room temperature</p> <p>b Desired room temperature</p>		

If scheduling is on after changing the desired room temperature

- The temperature will stay the same as long as there is no scheduled action.
- The desired room temperature will return to its scheduled value whenever a scheduled action occurs.

You can avoid scheduled behaviour by (temporarily) turning off scheduling.

To turn off room temperature scheduling

1	Go to [1.1]: Room > Schedule.	🏠●●●●●
2	Select No.	🏠●●●●●

5.6.5 To change the desired leaving water temperature



INFORMATION

The leaving water is the water that is sent to the heat emitters. The desired leaving water temperature is set by your installer in accordance with the heat emitter type. Only adjust the leaving water temperature settings in case of problems.

You can use the leaving water temperature setpoint screen to read out and adjust the desired leaving water temperature.

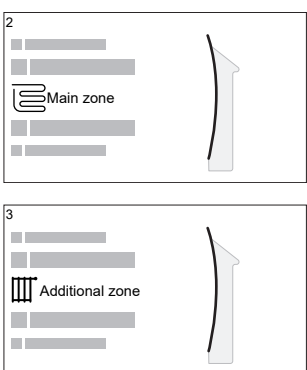
1	Go to [2]: Main zone or [3]: Additional zone.	🏠●●●●●
		

2	Adjust the desired leaving water temperature.	○●●●○▶
<p>a Actual leaving water temperature</p> <p>b Desired leaving water temperature</p>		

If scheduling is on after changing the desired leaving water temperature

- The temperature will stay the same as long as there is no scheduled action.
- The desired leaving water temperature will return to its scheduled value whenever a scheduled action occurs.

You can avoid scheduled behaviour by (temporarily) turning off scheduling.

To turn off leaving water temperature scheduling

1	Go to one of the following: <ul style="list-style-type: none"> ▪ [2.1]: Main zone > Schedule ▪ [3.1]: Additional zone > Schedule 	🔊●●●○
2	Select No.	🔊●●●○

To enable weather-dependent operation for the leaving water temperature

See "5.9.4 Using weather-dependent curves" [▶ 46].

5.7 Domestic hot water control

5.7.1 About domestic hot water control

Depending on the DHW tank mode (installer setting), you use a different domestic hot water control:

- Reheat only
- Schedule + reheat
- Schedule only

**INFORMATION**

In case of error code AH and no interruption of the disinfection function occurred due to domestic hot water tapping, following actions are recommended:

- When the **Reheat only** or **Schedule + reheat** mode is selected, it is recommended to program the start-up of the disinfection function at least 4 hours later than the last expected large hot water tapping. This start-up can be set by installer settings (disinfection function).
- When the **Schedule only** mode is selected, it is recommended to program an **Eco** action 3 hours before the scheduled start-up of the disinfection function to preheat the tank.

When weather-dependent operation is used for the tank, the tank temperature is determined automatically by the outdoor temperature. For more information, see "[5.9 Weather-dependent curve](#)" [▶ 43].

To determine which domestic hot water mode you are using (method 1)

Check the installer settings table filled in by the installer.

To determine which domestic hot water mode you are using (method 2)

1	Go to [5]: Tank.	🔍⋯○
2	Check which items are displayed:	🔍●⋯○

If... is displayed	Then the DHW tank mode =...
Only [5.1] Powerful operation	Reheat only
All items except [5.4] Reheat setpoint are displayed	Schedule only
All items including [5.4] Reheat setpoint are displayed	Schedule + reheat

5.7.2 Reheat mode

In reheat mode, the DHW tank continuously heats up to the temperature shown on the home screen (example: 50°C) when the temperature drops below a certain value.

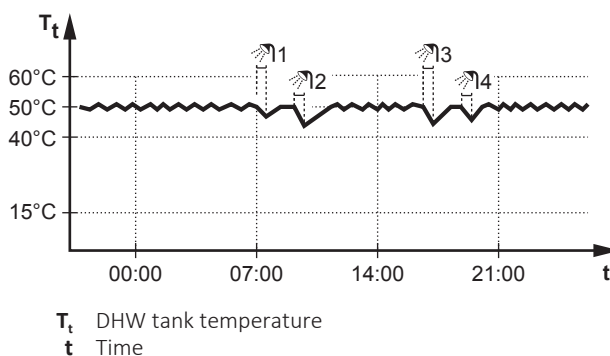

**INFORMATION**

When the DHW tank mode is reheat, the risk for capacity shortage and comfort problem is significant. In case of frequent reheat operation, space heating/cooling function is regularly interrupted.

5.7.3 Scheduled mode

In scheduled mode, the DHW tank produces hot water corresponding to a schedule. The best time to allow the tank to produce hot water is at night, because the space heating demand is lower.

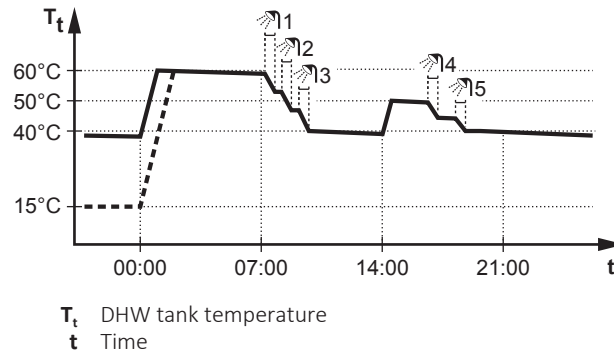
Example:

- Initially, the DHW tank temperature is the same as the temperature of the domestic water entering the DHW tank (example: **15°C**).
- At 00:00 the DHW tank is programmed to heat up the water to a preset value (example: **Comfort = 60°C**).
- During the morning, you consume hot water and the DHW tank temperature decreases.
- At 14:00 the DHW tank is programmed to heat up the water to a preset value (example: **Eco = 50°C**). Hot water is available again.
- During the afternoon and evening, you consume hot water again and the DHW tank temperature decreases again.
- At 00:00 the next day, the cycle repeats.



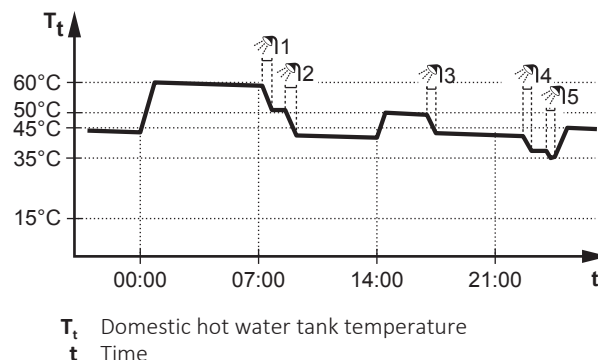

5.7.4 Scheduled + reheat mode

In scheduled + reheat mode, the domestic hot water control is the same as in scheduled mode. However, when the DHW tank temperature drops below a preset value (=reheat tank temperature – hysteresis value; example: 35°C), the DHW tank heats up until it reaches the reheat set point (example: 45°C). This ensures that a minimum amount of hot water is available at all times.

Example:

5.7.5 To change the domestic hot water temperature

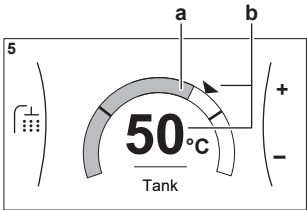
In **Reheat only** mode, you can use the tank temperature setpoint screen to read out and adjust the domestic hot water temperature.

1	Go to [5]: Tank. 	
2	Adjust the domestic hot water temperature.  a Actual domestic hot water temperature b Desired domestic hot water temperature	

In other modes, you can only view the setpoint screen but not modify it. Instead, you can modify the settings for the **Comfort setpoint** [5.2], **Eco setpoint** [5.3] and **Reheat setpoint** [5.4].

When weather-dependent operation is used for the tank, the tank temperature is determined automatically by the outdoor temperature. For more information, see "[5.9 Weather-dependent curve](#)" [▶ 43].

5.7.6 Using DHW powerful operation



About powerful operation

Powerful operation allows the domestic hot water to be heated by the backup heater. Use this mode on days when there is more hot water usage than usual.

To check if powerful operation is active

If  is displayed on the home screen, powerful operation is active.

Activate or deactivate **Powerful operation** as follows:

1	Go to [5.1]: Tank > Powerful operation	
2	Turn powerful operation Off or On .	

Usage example: You immediately need more hot water

You are in the following situation:

- You already consumed most of your domestic hot water.
- You cannot wait for the next scheduled action to heat up the domestic hot water tank.

Then you can activate powerful operation. The domestic hot water tank will start heating up the water to the **Comfort** temperature.

**INFORMATION**

When powerful operation is active, the risk of space heating/cooling and capacity shortage comfort problems is significant. In case of frequent domestic hot water operation, frequent and long space heating/cooling interruptions will happen.

5.8 Preset values and schedules

5.8.1 Using preset values

About preset values

For some settings in the system, you can define preset values. You only need to set these values one time, then reuse the values in other screens such as the scheduling screen. If you later want to change the value, you only have to do it in one place.

Possible preset values

You can set the following user-defined preset values:

Preset value		Where used
Tank temperatures under [5] Tank Restriction: Only applicable if a DHW tank is present.	[5.2] Comfort setpoint	You can use these preset values in [5.5] Schedule (weekly schedule screen for the DHW tank) if the DHW tank mode is one of the following: <ul style="list-style-type: none"> ▪ Schedule only ▪ Schedule + reheat
	[5.3] Eco setpoint	
	[5.4] Reheat setpoint	The software uses this preset value if the DHW tank mode is Schedule + reheat .
Electricity prices under [7.5] User settings > Electricity price Restriction: Only applicable if Bivalent is enabled by the installer.	[7.5.1] High	You can use these preset values in [7.5.4] Schedule (weekly schedule screen for the energy prices). See " 5.8.4 Setting the energy prices " [▶ 41].
	[7.5.2] Medium	
	[7.5.3] Low	

Additional to the user-defined preset values, the system also contains some system-defined preset values that you can use when programming schedules.

Example: In [7.4.2] **User settings > Quiet > Schedule** (weekly schedule for when the unit has to use which quiet mode level), you can use the following system-defined preset values: **Quiet/More quiet/Most quiet**.





5.8.2 Using and programming schedules

About schedules

Depending on your system layout and installer configuration, schedules for multiple controls may be available.

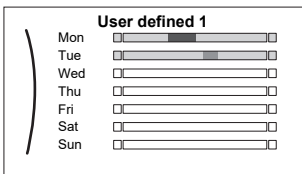
You can...	See...
Set if a specific control needs to act according to a schedule.	" Activation screen " in " Possible schedules " [▶ 35]
Select which schedule you currently want to use for a specific control. The system contains some predefined schedules. You can:	
Consult which schedule is currently selected.	" Schedule/Control " in " Possible schedules " [▶ 35]
Select another schedule if needed.	" To select which schedule you currently want to use " [▶ 35]
Program your own schedules if the predefined schedules are not satisfactory. The actions you can program are control specific.	<ul style="list-style-type: none"> ▪ "Possible actions" in "Possible schedules" [▶ 35] ▪ "5.8.3 Schedule screen: Example" [▶ 37]

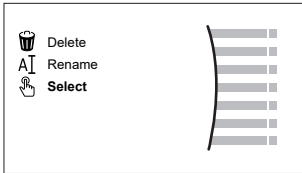
To select which schedule you currently want to use

1	Go to the schedule for the specific control. See " Schedule/Control " in " Possible schedules " [▶ 35]. Example: For the schedule for the desired room temperature in heating mode, go to [1.2] Room > Heating schedule.	
2	Select the name of the current schedule. 	
3	Select Select . 	
4	Select the schedule that you currently want to use.	

Possible schedules

The table contains the following information:

- **Schedule/Control:** This column shows you where you can consult the currently selected schedule for the specific control. If needed, you can:
 - Select another schedule. See "[To select which schedule you currently want to use](#)" [▶ 35].
 - Program your own schedule. See "[5.8.3 Schedule screen: Example](#)" [▶ 37].
- **Predefined schedules:** Number of available predefined schedules in the system for the specific control. If needed, you can program your own schedule.
- **Activation screen:** For most controls, a schedule is only effective if it activated in its corresponding activation screen. This entry shows you where to activate it.
- **Possible actions:** Actions you can use when programming a schedule. For most schedules, you can program up to 6 actions per day.

Schedule/Control	Description
<p>[1.2] Room > Heating schedule</p> <p>Schedule for the desired room temperature in heating mode.</p>	<p>Predefined schedules: 3</p> <p>Activation screen: [1.1] Schedule</p> <p>Possible actions: Temperatures within range.</p>
<p>[1.3] Room > Cooling schedule</p> <p>Schedule for the desired room temperature in cooling mode.</p>	<p>Predefined schedules: 1</p> <p>Activation screen: [1.1] Schedule</p> <p>Possible actions: Temperatures within range.</p>
<p>[2.2] Main zone > Heating schedule</p> <p>Schedule for the desired leaving water temperature for the main zone in heating mode.</p>	<p>Predefined schedules: 3</p> <p>Activation screen: [2.1] Schedule</p> <p>Possible actions:</p> <ul style="list-style-type: none"> ▪ In case of weather-dependent: Shift temperatures within range. ▪ Otherwise: Temperatures within range
<p>[2.3] Main zone > Cooling schedule</p> <p>Schedule for the desired leaving water temperature for the main zone in cooling mode.</p>	<p>Predefined schedules: 1</p> <p>Activation screen: [2.1] Schedule</p> <p>Possible actions:</p> <ul style="list-style-type: none"> ▪ In case of weather-dependent: Shift temperatures within range. ▪ Otherwise: Temperatures within range
<p>[3.2] Additional zone > Heating schedule</p> <p>Schedule for when the system is allowed to heat up the additional zone in heating mode.</p>	<p>Predefined schedules: 1</p> <p>Activation screen: [3.1] Schedule</p> <p>Possible actions:</p> <ul style="list-style-type: none"> ▪ Off: When the system is NOT allowed to heat up the additional zone. ▪ On: When the system is allowed to heat up the additional zone.
<p>[3.3] Additional zone > Cooling schedule</p> <p>Schedule for when the system is allowed to cool down the additional zone in cooling mode.</p>	<p>Predefined schedules: 1</p> <p>Activation screen: [3.1] Schedule</p> <p>Possible actions:</p> <ul style="list-style-type: none"> ▪ Off: When the system is NOT allowed to cool down the additional zone. ▪ On: When the system is allowed to cool down the additional zone.
<p>[4.2] Space heating/cooling > Operation mode schedule</p> <p>Schedule (per month) for when to operate the unit in heating mode and when in cooling mode.</p>	<p>See "To set the space operation mode" [▶ 27].</p>

Schedule/Control	Description
<p>[5.5] Tank > Schedule</p> <p>Schedule for the domestic hot water tank temperature for your normal domestic hot water needs.</p>	<p>Predefined schedules: 1</p> <p>Activation screen: Not applicable. This schedule is automatically activated if the DHW mode is one of the following:</p> <ul style="list-style-type: none"> ▪ Schedule only ▪ Schedule + reheat <p>Possible actions:</p> <ul style="list-style-type: none"> ▪ Comfort: When to start heating the tank to the user-defined preset value [5.2] Comfort setpoint. ▪ Eco: When to start heating the tank to the user-defined preset value [5.3] Eco setpoint. ▪ Stop: When to stop heating the tank, even if the desired tank temperature is not reached yet. <p>Note: In Schedule + reheat mode, the system also takes the user-defined preset value [5.4] Reheat setpoint into account.</p>
<p>[7.4.2] User settings > Quiet > Schedule</p> <p>Schedule for when the unit has to use which quiet mode level.</p>	<p>Predefined schedules: 1</p> <p>Activation screen: [7.4.1] Activation (only available to installers).</p> <p>Possible actions: You can use the following system-defined preset values:</p> <ul style="list-style-type: none"> ▪ Off ▪ Quiet ▪ More quiet ▪ Most quiet <p>See "About quiet mode" [▶ 49].</p>
<p>[7.5.4] User settings > Electricity price > Schedule</p> <p>Schedule for when a certain electricity tariff is valid.</p>	<p>Predefined schedules: 1</p> <p>Activation screen: Not applicable</p> <p>Possible actions: You can use the following system-defined preset values:</p> <ul style="list-style-type: none"> ▪ High ▪ Medium ▪ Low <p>See "5.8.4 Setting the energy prices" [▶ 41].</p>

5.8.3 Schedule screen: Example

This example shows how to set a room temperature schedule in heating mode for the main zone.



INFORMATION

The procedures to program other schedules are similar.

To program the schedule: overview

Example: You want to program the following schedule:

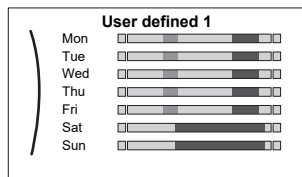

Prerequisite: The room temperature schedule is only available if room thermostat control is active. If leaving water temperature control is active, you can program the main zone schedule instead.

- 1 Go to the schedule.
- 2 (optional) Clear the content of the whole week schedule or the content of a selected day schedule.
- 3 Program the schedule for **Monday**.
- 4 Copy the schedule to the other weekdays.
- 5 Program the schedule for **Saturday** and copy it to **Sunday**.
- 6 Give the schedule a name.

To go to the schedule



1	Go to [1.1]: Room > Schedule.	
2	Set scheduling to Yes.	
3	Go to [1.2]: Room > Heating schedule.	

To clear the content of the week schedule







1	Select the name of the current schedule. 	
2	Select Delete . 	
3	Select OK to confirm.	

To clear the content of a day schedule

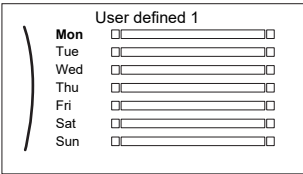

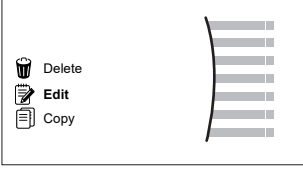
1	Select the day of which you want to clear the content. For example Friday 	
----------	--	--

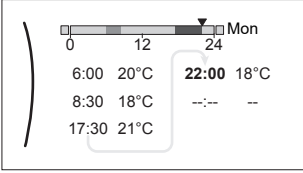



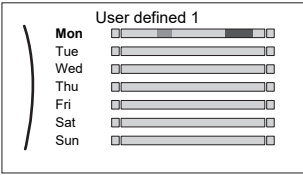

2	Select Delete . 	
3	Select OK to confirm.	

To program the schedule for Monday



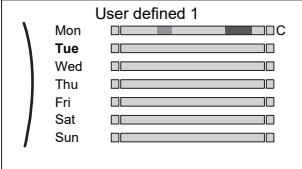

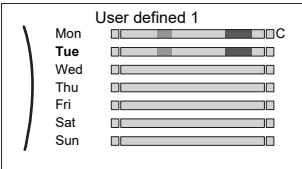

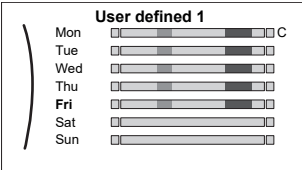

1	Select Monday . 	
2	Select Edit . 	
3	Use the left dial to select an entry and edit the entry with the right dial. You can program up to 6 actions each day. On the bar, a high temperature has a darker colour than a low temperature.  <p>Note: To clear an action, set its time as the time of the previous action.</p>	
4	Confirm the changes. Result: The schedule for Monday is defined. The value of the last action is valid until the next programmed action. In this example, Monday is the first day you programmed. Thus, the last programmed action is valid up to the first action of next Monday.	

To copy the schedule to the other weekdays

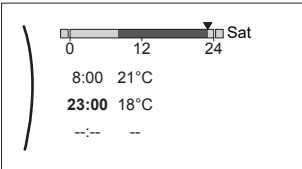
1	Select Monday . 	
---	---	---

<p>2</p>	<p>Select Copy.</p>  <p>Result: Next to the copied day, "C" is displayed.</p>	
<p>3</p>	<p>Select Tuesday.</p> 	
<p>4</p>	<p>Select Paste.</p>  <p>Result:</p> 	
<p>5</p>	<p>Repeat this action for all other weekdays.</p> 	<p>—</p>

To program the schedule for Saturday and copy it to Sunday

<p>1</p>	<p>Select Saturday.</p>	
<p>2</p>	<p>Select Edit.</p>	
<p>3</p>	<p>Use the left dial to select an entry and edit the entry with the right dial.</p> 	 
<p>4</p>	<p>Confirm the changes.</p>	
<p>5</p>	<p>Select Saturday.</p>	
<p>6</p>	<p>Select Copy.</p>	
<p>7</p>	<p>Select Sunday.</p>	

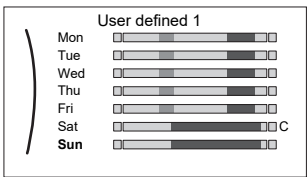
8	<p>Select Paste.</p> <p>Result:</p> 	
----------	--	--

To rename the schedule

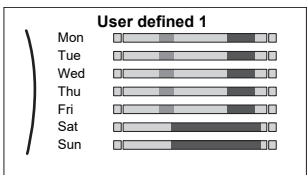
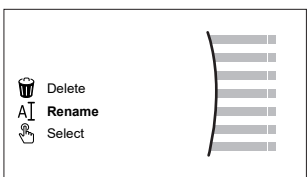
1	<p>Select the name of the current schedule.</p> 	
2	<p>Select Rename.</p> 	
3	<p>(optional) To delete the current schedule name, browse through the character list until ← is displayed, then press to remove the previous character. Repeat for each character of the schedule name.</p>	
4	<p>To name the current schedule, browse through the character list and confirm the selected character. The schedule name can contain up to 15 characters.</p>	
5	<p>Confirm the new name.</p>	



INFORMATION

Not all schedules can be renamed.

Usage example: You work in a 3-shift system

If you work in a 3-shift system, you can do the following:

- 1** Program 3 room temperature schedules and give them appropriate names.
Example: EarlyShift, DayShift and LateShift
- 2** Select the schedule that you currently want to use.

5.8.4 Setting the energy prices

In the system, you can set the following energy prices:

- a fixed gas price
- 3 electricity price levels
- a weekly schedule timer for electricity prices.

Example: How to set the energy prices on the user interface?

Price	Value in breadcrumb
Gas: 5.3 euro cents/kWh	[7.6]=5.3
Electricity: 12 euro cents/kWh	[7.5.1]=12

To set the gas price

1	Go to [7.6]: User settings > Gas price.	
2	Select the correct gas price.	
3	Confirm the changes.	



INFORMATION

Price value ranging from 0.00~990 valuta/kWh (with 2 significant values).

To set the electricity price

1	Go to [7.5.1]/[7.5.2]/[7.5.3]: User settings > Electricity price > High/Medium/Low.	
2	Select the correct electricity price.	
3	Confirm the changes.	
4	Repeat this for all three electricity prices.	—



INFORMATION

Price value ranging from 0.00~990 valuta/kWh (with 2 significant values).



INFORMATION

If no schedule is set, the **Electricity price** for **High** is taken into account.

To set the electricity price schedule timer

1	Go to [7.5.4]: User settings > Electricity price > Schedule.	
2	Program the selection using the scheduling screen. You can set the High , Medium and Low electricity prices according to your electricity supplier.	—
3	Confirm the changes.	



INFORMATION

The values correspond with the electricity price values for **High**, **Medium** and **Low** previously set. If no schedule is set, the electricity price for **High** is taken into account.

About energy prices in case of an incentive per kWh renewable energy

An incentive can be taken into account when setting the energy prices. Although the running cost can increase, the total operation cost, taking into account the reimbursement will be optimized.



NOTICE

Make sure to modify the setting of the energy prices at the end of the incentive period.

To set the gas price in case of an incentive per kWh renewable energy

Calculate the value for the gas price with the following formula:

- Actual gas price+(Incentive/kWh×0.9)

For the procedure to set the gas price, see ["To set the gas price"](#) [▶ 42].

To set the electricity price in case of an incentive per kWh renewable energy

Calculate the value for the electricity price with following formula:

- Actual electricity price+Incentive/kWh

For the procedure to set the electricity price, see ["To set the electricity price"](#) [▶ 42].

Example

This is an example and the prices and/or values used in this example are NOT accurate.

Data	Price/kWh
Gas price	4.08
Electricity price	12.49
Renewable heat incentive per kWh	5

Calculation of the gas price

Gas price=Actual gas price+(Incentive/kWh×0.9)

Gas price=4.08+(5×0.9)

Gas price=8.58

Calculation of the electricity price

Electricity price=Actual electricity price+Incentive/kWh

Electricity price=12.49+5

Electricity price=17.49

Price	Value in breadcrumb
Gas: 4.08 /kWh	[7.6]=8.6
Electricity: 12.49 /kWh	[7.5.1]=17

5.9 Weather-dependent curve

5.9.1 What is a weather-dependent curve?

Weather-dependent operation

The unit operates 'weather-dependent' if the desired leaving water or tank temperature is determined automatically by the outdoor temperature. It therefore is connected to a temperature sensor on the North wall of the building. If the outdoor temperature drops or rises, the unit compensates instantly. Thus, the unit does not have to wait for feedback by the thermostat to increase or decrease the temperature of the leaving water or tank. Because it reacts more quickly, it prevents high rises and drops of the indoor temperature and water temperature at tap points.

Advantage

Weather-dependent operation reduces energy consumption.

Weather-dependent curve

To be able to compensate for differences in temperature, the unit relies on its weather-dependent curve. This curve defines how much the temperature of the tank or leaving water must be at different outdoor temperatures. Because the slope of the curve depends on local circumstances such as climate and the insulation of the building, the curve can be adjusted by an installer or user.

Types of weather-dependent curve

There are 2 types of weather-dependent curves:

- 2-points curve
- Slope-offset curve

Which type of curve you use to make adjustments, depends on your personal preference. See "[5.9.4 Using weather-dependent curves](#)" [▶ 46].

Availability

The weather-dependent curve is available for:

- Main zone - Heating
- Main zone - Cooling
- Additional zone - Heating
- Additional zone - Cooling
- Tank (only available to installers)



INFORMATION

To operate weather-dependent, correctly configure the setpoint of the main zone, additional zone or tank. See "[5.9.4 Using weather-dependent curves](#)" [▶ 46].

5.9.2 2-points curve

Define the weather-dependent curve with these two setpoints:

- Setpoint (X1, Y2)
- Setpoint (X2, Y1)

Example

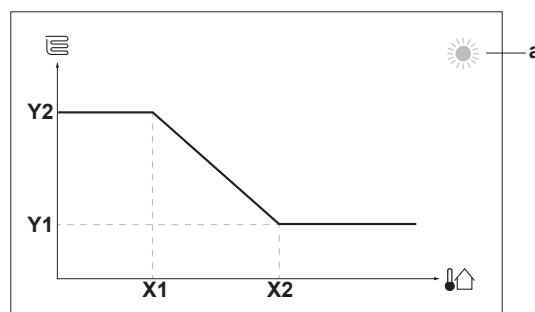

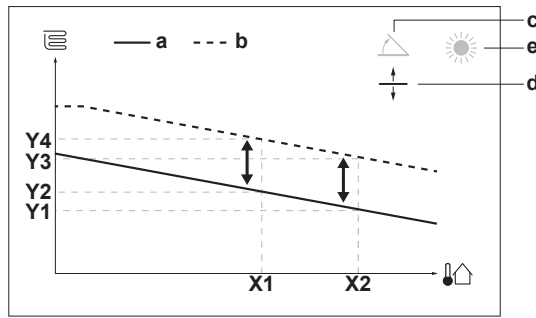

Item	Description
a	WD curve before changes.
b	WD curve after changes (as example): <ul style="list-style-type: none"> ▪ When slope is changed, the new preferred temperature at X1 is unequally higher than the preferred temperature at X2. ▪ When offset is changed, the new preferred temperature at X1 is equally higher as the preferred temperature at X2.
c	Slope
d	Offset
e	Selected weather-dependent zone: <ul style="list-style-type: none"> ▪ ☀: Main zone or additional zone heating ▪ ❄: Main zone or additional zone cooling ▪ 🏠: Domestic hot water
X1, X2	Examples of outdoor ambient temperature
Y1, Y2, Y3, Y4	Examples of desired tank temperature or leaving water temperature. The icon corresponds to the heat emitter for that zone: <ul style="list-style-type: none"> ▪ 🏠: Underfloor heating ▪ 🌀: Fan coil unit ▪ 🏠: Radiator ▪ 🏠: Domestic hot water tank

Possible actions on this screen	
🔍⋯○	Select slope or offset.
○⋯🔍	Increase or decrease the slope/offset.
○⋯🏠	When slope is selected: set slope and go to offset. When offset is selected: set offset.
🏠⋯○	Confirm changes and return to the submenu.

5.9.4 Using weather-dependent curves

Configure weather-dependent curves as following:

To define the setpoint mode

To use the weather-dependent curve, you need to define the correct setpoint mode:

Go to setpoint mode ...	Set the setpoint mode to ...
Main zone – Heating	
[2.4] Main zone > Setpoint mode	WD heating, fixed cooling OR Weather dependent
Main zone – Cooling	
[2.4] Main zone > Setpoint mode	Weather dependent
Additional zone – Heating	
[3.4] Additional zone > Setpoint mode	WD heating, fixed cooling OR Weather dependent
Additional zone – Cooling	
[3.4] Additional zone > Setpoint mode	Weather dependent
Tank	
[5.B] Tank > Setpoint mode	Restriction: Only available to installers. Weather dependent

To change the type of weather-dependent curve

To change the type for all zones (main + additional) and for the tank, go to [2.E] Main zone > WD curve type.

Viewing which type is selected is also possible via:

- [3.C] Additional zone > WD curve type
- [5.E] Tank > WD curve type

Restriction: Only available to installers.

To change the weather-dependent curve

Zone	Go to ...
Main zone – Heating	[2.5] Main zone > Heating WD curve
Main zone – Cooling	[2.6] Main zone > Cooling WD curve
Additional zone – Heating	[3.5] Additional zone > Heating WD curve
Additional zone – Cooling	[3.6] Additional zone > Cooling WD curve
Tank	Restriction: Only available to installers. [5.C] Tank > WD curve



INFORMATION

Maximum and minimum setpoints

You cannot configure the curve with temperatures that are higher or lower than the set maximum and minimum setpoints for that zone or for the tank. When the maximum or minimum setpoint is reached, the curve flattens out.

To fine-tune the weather-dependent curve: slope-offset curve

The following table describes how to fine-tune the weather-dependent curve of a zone or tank:

You feel ...		Fine-tune with slope and offset:	
At regular outdoor temperatures ...	At cold outdoor temperatures ...	Slope	Offset
OK	Cold	↑	—
OK	Hot	↓	—
Cold	OK	↓	↑
Cold	Cold	—	↑
Cold	Hot	↓	↑
Hot	OK	↑	↓
Hot	Cold	↑	↓
Hot	Hot	—	↓

To fine-tune the weather-dependent curve: 2-points curve

The following table describes how to fine-tune the weather-dependent curve of a zone or tank:

You feel ...		Fine-tune with setpoints:			
At regular outdoor temperatures ...	At cold outdoor temperatures ...	Y2 ^(a)	Y1 ^(a)	X1 ^(a)	X2 ^(a)
OK	Cold	↑	—	↑	—
OK	Hot	↓	—	↓	—
Cold	OK	—	↑	—	↑
Cold	Cold	↑	↑	↑	↑
Cold	Hot	↓	↑	↓	↑
Hot	OK	—	↓	—	↓
Hot	Cold	↑	↓	↑	↓
Hot	Hot	↓	↓	↓	↓

^(a) See "5.9.2 2-points curve" [▶ 44].

5.10 Other functionalities

5.10.1 To configure time and date

1	Go to [7.2] User settings > Time/date.	
----------	--	---

5.10.2 Using quiet mode

About quiet mode

You can use quiet mode to decrease the sound of the outdoor unit. However, this also decreases the heating/cooling capacity of the system. There are multiple quiet mode levels.

The installer can:

- Completely deactivate quiet mode
- Manually activate a quiet mode level
- Enable the user to program a quiet mode schedule
- Configure restrictions based on local regulations

If enabled by the installer, the user can program a quiet mode schedule.



INFORMATION

If the outdoor temperature is below zero, we recommend to NOT use the most quiet level.

To check if quiet mode is active

If  is displayed on the home screen, quiet mode is active.

To program a quiet mode schedule

Restriction: Only possible if enabled by the installer.

1	Go to [7.4.2]: User settings > Quiet > Schedule.	
2	Program the schedule. Possible actions: You can use the following system-defined preset values: <ul style="list-style-type: none"> ▪ Off ▪ Quiet ▪ More quiet ▪ Most quiet For more information about scheduling, see " 5.8.2 Using and programming schedules " [▶ 34].	—

5.10.3 Using holiday mode

About holiday mode

During your holiday, you can use the holiday mode to deviate from your normal schedules without having to change them. While holiday mode is active, space heating/cooling operation and domestic hot water operation will be turned off. Room frost protection and disinfection operation will remain active.

Typical workflow

Using holiday mode typically consists of the following stages:

- 1 Activating the holiday mode.
- 2 Setting the starting date and ending date of your holiday.

To check if holiday mode is activated and/or running

If  is displayed on the home screen, holiday mode is active.

To configure the holiday

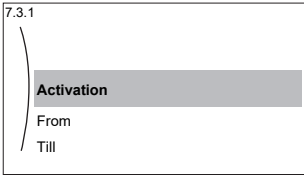
1	Activate the holiday mode.	—
	<ul style="list-style-type: none"> Go to [7.3.1]: User settings > Holiday > Activation. 	
	<ul style="list-style-type: none"> Select On. 	
2	Set the first day of your holiday.	—
	<ul style="list-style-type: none"> Go to [7.3.2]: From. 	
	<ul style="list-style-type: none"> Select a date. 	
	<ul style="list-style-type: none"> Confirm the changes. 	
3	Set the last day of your holiday.	—
	<ul style="list-style-type: none"> Go to [7.3.3]: Till. 	
	<ul style="list-style-type: none"> Select a date. 	
	<ul style="list-style-type: none"> Confirm the changes. 	

5.10.4 Using WLAN

 **INFORMATION**

Restriction: WLAN settings are only visible when a WLAN cartridge or WLAN module is installed.

About the WLAN cartridge or WLAN module

The WLAN cartridge or WLAN module (only one of the two needed) connects the system to the internet. As user you can then control the system via the ONECTA app.

This needs the following components **in case of WLAN cartridge:**

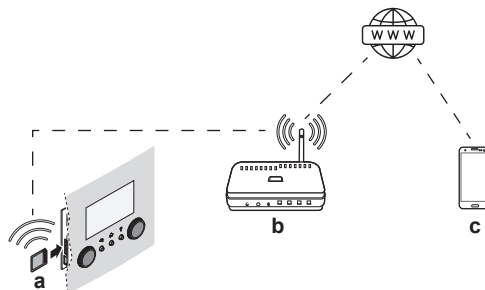

This needs the following components **in case of WLAN module:**

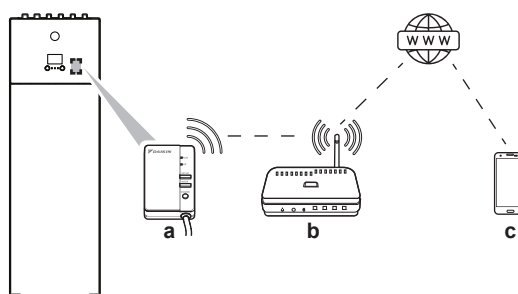

a	WLAN cartridge	The WLAN cartridge needs to be inserted in the user interface.
	WLAN module	The WLAN module needs to be installed by the installer on the indoor unit (on the inside of the front panel).
b	Router	Field supply.
c	Smartphone + app 	The ONECTA app needs to be installed on the user's smartphone. See: http://www.onlinecontroller.daikineurope.com/



Configuration

To configure the ONECTA app, follow the in-app instructions. While doing this, the following actions and information are needed on the user interface:

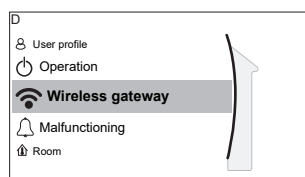

[D] Wireless gateway

[D.1] Mode

[D.2] Reboot



[D.3] WPS

[D.4] Remove from cloud



[D.5] Home network connection

[D.6] Cloud connection

[D.1] **Mode:** Turn AP mode ON (= WLAN cartridge active as access point):

1	Go to [D.1]: Wireless gateway > Mode .	
2	In the Enable AP mode screen, select Yes .	

[D.2] **Reboot:** Reboot the WLAN cartridge:

1	Go to [D.2]: Wireless gateway > Reboot .	
2	In the Reboot the gateway screen, select OK .	

[D.3] **WPS:** Connect the WLAN cartridge to the router:



INFORMATION

You can only use this function if it is supported by the software version of the WLAN, and the software version of the ONECTA app.

1	Go to [D.3]: Wireless gateway > WPS .	
----------	---	---

2	In the WPS screen, select Yes .	
----------	---	---

[D.4] **Remove from cloud**: Remove the WLAN cartridge from the cloud:

1	Go to [D.4]: Wireless gateway > Remove from cloud .	
----------	---	---

2	In the Remove from cloud screen, select Yes .	
----------	---	---

[D.5] **Home network connection**: Read out the status of the connection to the home network:

1	Go to [D.5]: Wireless gateway > Home network connection .	
----------	---	---

2	Read out the connection status: <ul style="list-style-type: none"> ▪ Disconnected from [WLAN_SSID] ▪ Connected to [WLAN_SSID] 	
----------	---	---

[D.6] **Cloud connection**: Read out the status of the connection to the cloud:

1	Go to [D.6]: Wireless gateway > Cloud connection .	
----------	--	---

2	Read out the connection status: <ul style="list-style-type: none"> ▪ Not connected ▪ Connected 	
----------	--	---

6 Energy saving tips

Tips about room temperature

- Make sure the desired room temperature is NEVER too high (in heating mode) or too low (in cooling mode), but ALWAYS according to your actual needs. Each saved degree can save up to 6% of heating/cooling costs.
- Do NOT increase/decrease the desired room temperature to speed up space heating/cooling. The space will NOT heat up/cool down faster.
- When your system layout contains slow heat emitters (example: underfloor heating), avoid large fluctuation of the desired room temperature and do NOT let the room temperature drop too low/rise too high. It will take more time and energy to heat up/cool down the room again.
- Use a weekly schedule for your normal space heating or cooling needs. If necessary, you can easily deviate from the schedule:
 - For shorter periods: You can overrule the scheduled room temperature until the next scheduled action. **Example:** When you have a party, or when you are leaving for a couple of hours.
 - For longer periods: You can use the holiday mode.

Tips about leaving water temperature

- In heating mode, a lower desired leaving water temperature results in lower energy consumption and better performance. In cooling, the opposite is valid.
- Set the desired leaving water temperature in accordance with the heat emitter type. **Example:** Underfloor heating is designed for lower leaving water temperature than radiators and heat pump convectors.

Tips about DHW tank temperature

- Use a weekly schedule for your normal domestic hot water needs (ONLY in scheduled mode).
 - Program to heat up the DHW tank to a preset value (**Comfort** = higher DHW tank temperature) during the night, because then space heating demand is lower.
 - If heating up the DHW tank once at night is NOT sufficient, program to additionally heat up the DHW tank to a preset value (**Eco** = lower DHW tank temperature) during the day.
- Make sure the desired DHW tank temperature is NOT too high. **Example:** After installation, lower the DHW tank temperature daily by 1°C and check if you still have enough hot water.

7 Maintenance and service

7.1 Overview: Maintenance and service

The installer has to perform a yearly maintenance. You can find the contact/helpdesk number via the user interface.

1	Go to [8.3]: Information > Dealer information.	
----------	--	---

As end user, you have to:

- Keep the area around the unit clean.
- Keep the user interface clean with a soft damp cloth. Do NOT use any detergents.
- Regularly check if the water pressure is above 1 bar.

Refrigerant

This product contains fluorinated greenhouse gases. Do NOT vent gases into the atmosphere.

Refrigerant type: R32

Global warming potential (GWP) value: 675

Periodical inspections for refrigerant leaks may be required depending on the applicable legislation. Contact your installer for more information.



NOTICE

Applicable legislation on **fluorinated greenhouse gases** requires that the refrigerant charge of the unit is indicated both in weight and CO₂ equivalent.

Formula to calculate the quantity in CO₂ equivalent tonnes: GWP value of the refrigerant × total refrigerant charge [in kg]/1000

Contact your installer for more information.



WARNING: MILDLY FLAMMABLE MATERIAL

The refrigerant inside this unit is mildly flammable.



WARNING

- The refrigerant inside the unit is mildly flammable, but normally does NOT leak. If the refrigerant leaks in the room and comes in contact with fire from a burner, a heater, or a cooker, this may result in fire, or the formation of a harmful gas.
- Turn OFF any combustible heating devices, ventilate the room, and contact the dealer where you purchased the unit.
- Do NOT use the unit until a service person confirms that the part from which the refrigerant leaked has been repaired.



WARNING

The appliance shall be stored in a room without continuously operating ignition sources (example: open flames, an operating gas appliance or an operating electric heater).



WARNING

- Do NOT pierce or burn refrigerant cycle parts.
- Do NOT use cleaning materials or means to accelerate the defrosting process other than those recommended by the manufacturer.
- Be aware that the refrigerant inside the system is odourless.

8 Troubleshooting



Contact

For the symptoms listed below, you can try to solve the problem yourself. For any other problem, contact your installer. You can find the contact/helpdesk number via the user interface.

1	Go to [8.3]: Information > Dealer information.	
----------	--	---

8.1 To display the help text in case of a malfunction

In case of a malfunction, the following will appear on the home screen depending on the severity:

- : Error
- : Malfunction

You can get a short and a long description of the malfunction as follows:

1	Press the left dial to open the main menu and go to Malfunctioning. Result: A short description of the error and the error code is displayed on the screen.	
2	Press ? in the error screen. Result: A long description of the error is displayed on the screen.	?

8.2 To check the malfunction history

Conditions: The user permission level is set to advanced end user.

1	Go to [8.2]: Information > Malfunction history.	
----------	---	---

You see a list of the most recent malfunctions.

8.3 Symptom: You are feeling too cold (hot) in your living room

Possible cause	Corrective action
The desired room temperature is too low (high).	<p>Increase (decrease) the desired room temperature. See "5.6.4 To change the desired room temperature" [▶ 28].</p> <p>If the problem recurs daily, do one of the following:</p> <ul style="list-style-type: none"> ▪ Increase (decrease) the room temperature preset value. See "5.8.1 Using preset values" [▶ 34]. ▪ Adjust the room temperature schedule. See "5.8.2 Using and programming schedules" [▶ 34] and "5.8.3 Schedule screen: Example" [▶ 37].
The desired room temperature cannot be reached.	Increase the desired leaving water temperature in accordance with the heat emitter type. See "5.6.5 To change the desired leaving water temperature" [▶ 29].
The weather-dependent curve is set incorrectly.	Adjust the weather-dependent curve. See "5.9 Weather-dependent curve" [▶ 43].

8.4 Symptom: The water at the tap is too cold

Possible cause	Corrective action
You ran out of domestic hot water because of unusually high consumption.	<p>If you immediately need domestic hot water, activate the DHW tank Powerful operation. However, this consumes extra energy. See "5.7.6 Using DHW powerful operation" [▶ 33].</p> <p>If the problems recurs daily, do one of the following:</p> <ul style="list-style-type: none"> ▪ Increase the DHW tank temperature preset value. See "5.8.1 Using preset values" [▶ 34]. ▪ Adjust the DHW tank temperature schedule. Example: Program to additionally heat up the DHW tank to a preset value (Eco setpoint = lower tank temperature) during the day. See "5.8.2 Using and programming schedules" [▶ 34] and "5.8.3 Schedule screen: Example" [▶ 37].
The desired DHW tank temperature is too low.	

8.5 Symptom: Heat pump failure

When the heat pump fails to operate, the backup heater can serve as an emergency heater. It then takes over the heat load either automatically or by manual interaction.

- When **Emergency** is set to **Automatic** and a heat pump failure occurs, the backup heater automatically takes over the domestic hot water production and space heating.
- When **Emergency** is set to **Manual** and a heat pump failure occurs, the domestic hot water heating and space heating stops.

To manually recover it via the user interface, go to the **Malfunctioning** main menu screen and confirm whether the backup heater can take over the heat load or not.

- Alternatively, when **Emergency** is set to:
 - **auto SH reduced/DHW on**, space heating is reduced but domestic hot water is still available.
 - **auto SH reduced/DHW off**, space heating is reduced and domestic hot water is NOT available.
 - **auto SH normal/DHW off**, space heating operates as normally but domestic hot water is NOT available.

Similarly as in **Manual** mode, the unit can take the full load with the backup heater if the user activates this via the **Malfunctioning** main menu screen.

When the heat pump fails,  or  will appear on the user interface.

Possible cause	Corrective action
Heat pump is damaged.	See "8.1 To display the help text in case of a malfunction" [▶ 56].





INFORMATION

When the backup heater takes over the heat load, electricity consumption will be considerably higher.

8.6 Symptom: The system is making gurgling noises after commissioning



Possible cause	Corrective action
There is air in the system.	Purge air from the system. ^(a)
Incorrect hydraulic balance.	To be performed by the installer: <ol style="list-style-type: none"> 1 Perform hydraulic balancing to assure that the flow is correctly distributed between the emitters. 2 If hydraulic balancing is not sufficient, change the pump limitation settings ([9-0D] and [9-0E] if applicable).

Possible cause	Corrective action
Various malfunctions.	Check if  or  is displayed on the home screen of the user interface. See "8.1 To display the help text in case of a malfunction" [▶ 56] for more information about the malfunction.

^(a) We recommend to purge air with the air purge function of the unit (to be performed by the installer). If you purge air from the heat emitters or collectors, mind the following:



WARNING

Air purging heat emitters or collectors. Before you purge air from heat emitters or collectors, check if  or  is displayed on the home screen of the user interface.

- If not, you can purge air immediately.
- If yes, make sure that the room where you want to purge air is sufficiently ventilated. **Reason:** Refrigerant might leak into the water circuit, and subsequently into the room when you purge air from the heat emitters or collectors.

9 Relocation

9.1 Overview: Relocation

If you want to relocate parts of your system, contact your installer. You can find the contact/helpdesk number via the user interface.

1	Go to [8.3]: Information > Dealer information.	
----------	--	---

10 Disposal

**NOTICE**

Do NOT try to dismantle the system yourself: dismantling of the system, treatment of the refrigerant, oil and other parts **MUST** comply with applicable legislation. Units **MUST** be treated at a specialised treatment facility for reuse, recycling and recovery.

11 Glossary

DHW = Domestic hot water

Hot water used, in any type of building, for domestic purposes.

LWT = Leaving water temperature

Water temperature at the water outlet of the unit.

Dealer

Sales distributor for the product.

Authorised installer

Technical skilled person who is qualified to install the product.

User

Person who is owner of the product and/or operates the product.

Applicable legislation

All international, European, national and local directives, laws, regulations and/or codes that are relevant and applicable for a certain product or domain.

Service company

Qualified company which can perform or coordinate the required service to the product.

Installation manual

Instruction manual specified for a certain product or application, explaining how to install, configure and maintain it.

Operation manual

Instruction manual specified for a certain product or application, explaining how to operate it.

Accessories

Labels, manuals, information sheets and equipment that are delivered with the product and that need to be installed according to the instructions in the accompanying documentation.

Optional equipment

Equipment made or approved by Daikin that can be combined with the product according to the instructions in the accompanying documentation.

Field supply

Equipment NOT made by Daikin that can be combined with the product according to the instructions in the accompanying documentation.

12 Installer settings: Tables to be filled in by installer

12.1 Configuration wizard

Setting		Fill in...
System		
	Indoor unit type (read only)	
	Backup heater type [9.3.1] (read only)	
	Domestic hot water [9.2.1]	
	Emergency [9.5]	
	Number of zones [4.4]	
Backup heater		
	Voltage [9.3.2]	
	Configuration [9.3.3]	
	Capacity step 1 [9.3.4]	
	Additional capacity step 2 [9.3.5] (if applicable)	
Main zone		
	Emitter type [2.7]	
	Control [2.9]	
	Setpoint mode [2.4]	
	Schedule [2.1]	
	WD curve type [2.E]	
Additional zone (only if [4.4]=1, dual zone)		
	Emitter type [3.7]	
	Control (read only) [3.9]	
	Setpoint mode [3.4]	
	Schedule [3.1]	
	WD curve type [3.C] (read only)	
Tank		
	Heat up mode [5.6]	
	Comfort setpoint [5.2]	
	Eco setpoint [5.3]	
	Reheat setpoint [5.4]	
	Setpoint mode [5.B]	
	WD curve type [5.E] (read only)	

12.2 Settings menu

Setting		Fill in...
Main zone		
	Ext thermostat type [2.A]	
Additional zone (if applicable)		
	Ext thermostat type [3.A]	
Information		
	Dealer information [8.3]	







ERC