

**DAIKIN**



# INSTALLATION MANUAL

**Split System air conditioners**

FDQ125C5VEB

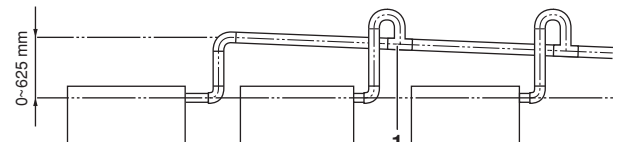
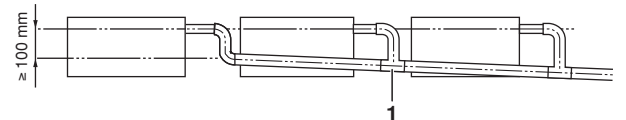
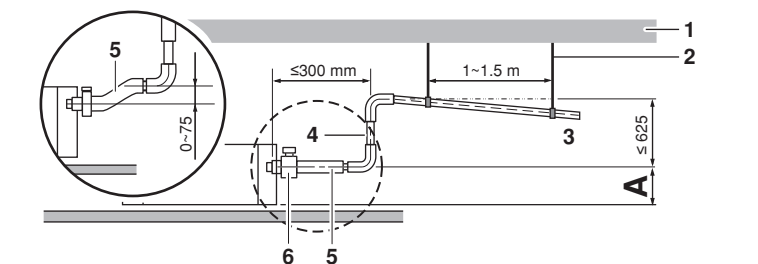
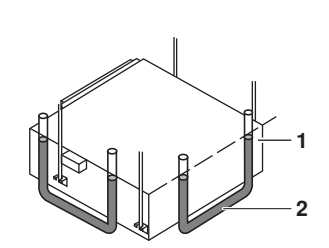
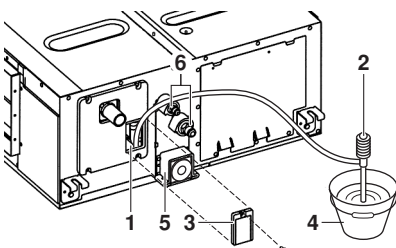
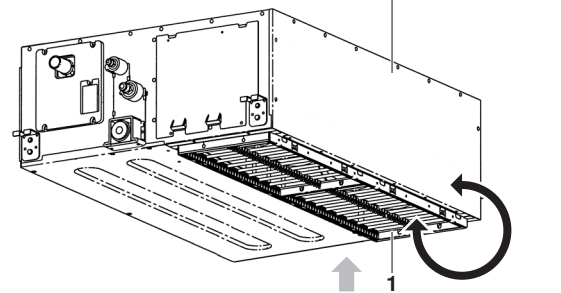
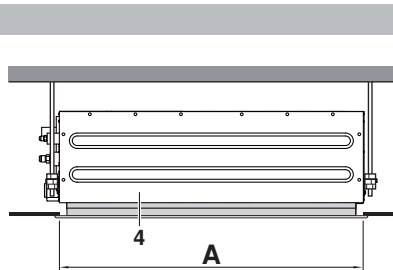
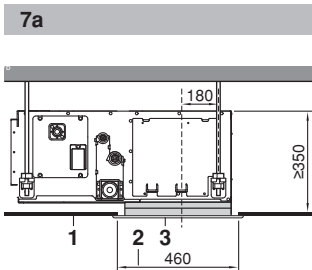
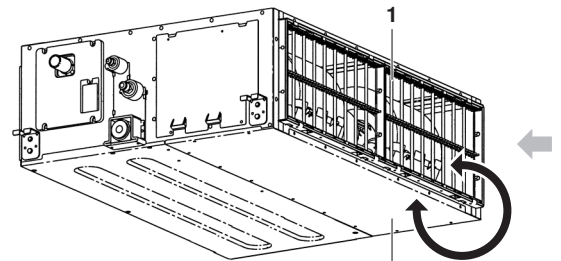
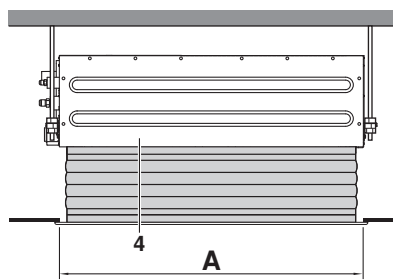
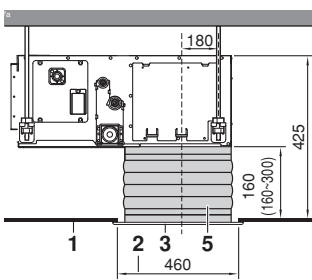
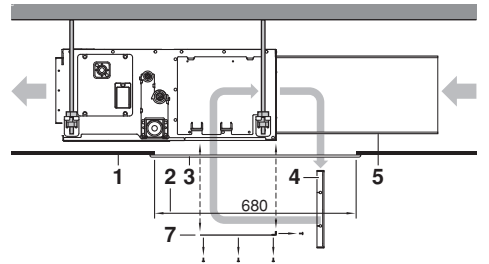
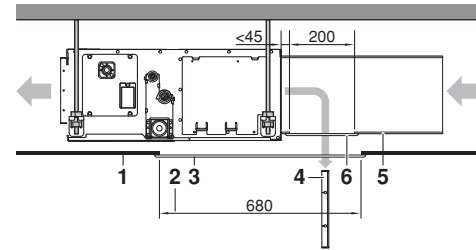
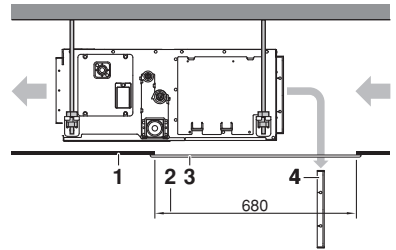
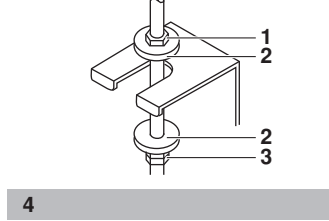
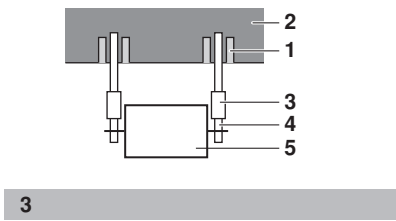
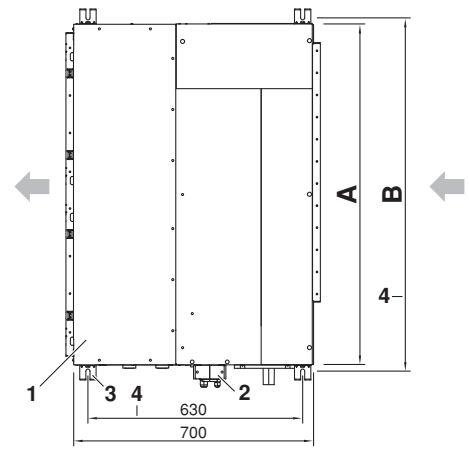
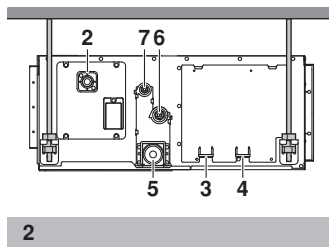
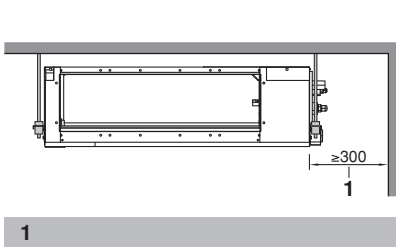

CE - DECLARACION-DE-CONFORMIDAD  
CE - DICHIARAZIONE-DI-CONFORMITA  
CE - ΔΗΛΩΣΗ ΣΥΜΜΟΡΦΩΣΗΣ  
CE - CONFORMITEITSVERKLARING

### Daikin Europe N.V.

- 01 (GB) declares under its sole responsibility that the air conditioning models to which this declaration relates;
- 02 (D) erklärt auf seine alleinige Verantwortung daß die Modelle der Klimaanlage für die diese Erklärung bestimmt ist;
- 03 (F) déclare sous sa seule responsabilité que les appareils d'air conditionné visés par la présente déclaration;
- 04 (NL) verklaart hierbij op eigen exclusieve verantwoordelijkheid dat de airconditioning units waarop deze verklaring betrekking heeft;
- 05 (E) declara bajo su única responsabilidad que los modelos de aire acondicionado a los cuales hace referencia la declaración;
- 06 (I) dichiara sotto sua responsabilità che i condizionatori modello a cui è riferita questa dichiarazione;
- 07 (C) δηλώνει ότι αποκλειστικά της ευθύνης ότι τα μοντέλα των κλιματιστικών συσκευών στα οποία αυτή η δήλωση αφορά;
- 08 (P) declara sob sua exclusiva responsabilidade que os modelos de ar condicionado a que esta declaração se refere.

### FDQ125CS5VEB.

- 01 are in conformity with the following standard(s) or other normative document(s), provided that these are used in accordance with our instructions:
- 02 (D) diesen folgenden Norm(en) oder einem anderen Normdokument oder -dokumenten entsprecht/sprechen, unter der Voraussetzung, daß sie gemäß unseren Anweisungen/regeln eingesetzt werden;
- 03 sont conformes à l'un ou l'autres (ou autres) document(s) normatif(s) pour autant qu'ils soient utilisés conformément à nos instructions;
- 04 conform de volgende norm(en) of één of meer andere bindende documenten zijn, op voorwaarde dat ze worden gebruikt overeenkomstig onze instructies;
- 05 están en conformidad con la(s) siguiente(s) norma(s) u otro(s) documento(s) normativo(s), siempre que sean utilizados de acuerdo con nuestras instrucciones;
- 06 sono conformi allo (alle) seguente(i) standard(i) o altro(i) documento(i) a carattere normativo, a patto che vengano usati in conformità alla nostra istruzioni;
- 07 είναι σύμφωνα με το(ι) ακόλουθ(ού) πρότυπο(ί) ή άλλο(α) έγγραφο(ί) κανονισμών, υπό την προϋπόθεση ότι χρησιμοποιούvτα σύμφωνα με τις οδηγίες μας;
- 08 Normen en andere technische specificaties.
- 09 Normen en andere technische specificaties.
- 10 onder rigthouding te bestemmen is:
- 11 enligt följande:
- 12 gilt i henhold til bestemte is:
- 13 conformément aux stipulations des:
- 14 overeenkomstig de bepalingen van:
- 15 siguiendo las disposiciones de:
- 16 prema odredbama:
- 17 u skladu sa odredbama iz:
- 18 in urma prevederilor:

### EN60335-2-40,

- 01 Note \* as set out in <A> and judged positively by <B>
- 02 Hinweis \* wie in der <A> aufgeführt und von <B> positiv beurteilt gemäß Zertifikat <C>
- 03 Remarque \* tel que défini dans <A> et évalué positivement par <B> conformément au Certificat <C>
- 04 Bemerk \* zoals vermeld in <A> en positief beoordeeld door <B> overeenkomstig Certificaat <C>
- 05 Nota \* como se establece en <A> y es valorado positivamente por <B> de acuerdo con el Certificado <C>
- 06 Nota \* as set out in <A> and judged positively by <B> according to the Certificate <C>
- 07 Značenje \* wie in der <A> aufgeführt und von <B> positiv beurteilt gemäß Zertifikat <C>
- 08 Nota \* tel como estabelecido em <A> e com o parecer positivo de <B> de acordo com o Certificado <C>
- 09 Примечание \* как указано в <A> и в соответствии с сертификатом <C>
- 10 Bemerk \* como se establece en <A> y es valorado positivamente por <B> de acuerdo con el Certificado <C>
- 11 Information \* enligt <A> och godkänns av <B> enligt Certifikat <C>
- 12 Mærk \* som defineret i <A> og godkendt positivt af <B> ifølge Serifikat <C>
- 13 Huom \* jolla on esitetty asiakirjassa <A> ja joka <B> on hyväksynyt Sertifikaatissa <C> mukaisesti.
- 14 Poznámka \* jak bylo uvedeno v <A> a pozitivně zjištěno v <B> v souhrnu osvědčení <C>
- 15 Napomena \* kako je izloženo u <A> pozitivno ocijenjeno od strane <B> prema Certifikatu <C>
- 16 Megjegyzés \* az <A> alapján, az <B> igazolta a megjelölt, az <C> tanúsítvány szerinti.
- 17 Uwaga \* zgodnie z dokumentacją <A>, pozytywny opinię wydał <B> w świadectwie <C>.
- 18 Note \* așa cum este stabilit în <A> și apreciat pozitiv în <B> în conformitate cu Certificatul <C>.
- 19 Opomba \* kolje dobreno v <A> in odobreno s strani <B> skladu s osvedčenjem <C>.
- 20 Märkus \* kako je izloženo u <A> pozitivno ocijenjeno od strane <B> prema Certifikatu <C>.
- 21 Zabeleška \* kako je izloženo u <A> i ocenjeno pozitivno od <B> sklažno Sertifikatu <C>.
- 22 Pastaba \* kaip nustatyta <A> ir kaip įvertinama išspėjta <B> pagal Sertifikatą <C>.
- 23 Pezámcs \* ká nörzdis <A> sz tekintve az szertifikát <C> vörélmam szákisa az szertifikát <C>.
- 24 Poznámka \* ako bolo uvedené v <A> s pozitívnou zisťou <B> v súlade s osvedčením <C>.
- 25 Nota \* <A> da beifolgende gibt die <C> Sertifikatsma göre <B> tarafından olumlu olarak değerlendirilmiştir.
- 26\*\* Daikin Europe N.V. is authorised to compile the Technical Construction File.
- 27\*\* H. Daikin Europe N.V. siva slobodnoimply na ovovršta, tav Teynikov fobokoa katakoxofu.
- 28\*\* A Daikin Europe N.V. esta autorizada a compilar a documentacia tecnica de fabrico.
- 29\*\* Kompanij Daikin Europe N.V. umovovovena sastaviti Komiterv tehnikovv dokumentaciu.
- 30\*\* Daikin Europe N.V. is authorised to compile the Dossier de Construction Technique.
- 31\*\* Daikin Europe N.V. er autoriseret til at udarbejde de tekniske konstruktionsdata.
- 32\*\* Daikin Europe N.V. er bemyndiget til sammanställa den tekniska konstruktionsfilen.
- 33\*\* Daikin Europe N.V. har tillatelse til å kompilere den Tekniske konstruktionsfilen.
- 34\*\* Daikin Europe N.V. is authorised to compile the Technical Construction File.
- 35\*\* Daikin Europe N.V. hat die Berechtigung die technische Konstruktionsakte zusammenzustellen.
- 36\*\* Daikin Europe N.V. est autorisé à compiler le Dossier de Construction Technique.
- 37\*\* Daikin Europe N.V. is bevoegd om het Technische Constructiebesseer samen te stellen.
- 38\*\* Daikin Europe N.V. está autorizado a compilar el Archivo de Construcción Técnica.
- 39\*\* Daikin Europe N.V. er autorizzata a redigere il File Tecnico di Costruzione.

CE - IZJAVA-O-USKLABENOSTI  
CE - ILMOUTUS-YHDENMUUKAISUDESTA  
CE - DEKLARACJA-ZGODNOSCI  
CE - DECLARATIE-DE-CONFORMITATE

- 09 (BG) заявява, включително под своето отговорност, че моделите климатичеров воздуха, к которым отпocтoяет настоящая заявлениe:
- 10 (Sv) erkläre under ens ansvar, at klimaanlegsmodele, som denne deklaration vedrører:
- 11 (S) deklarer i egenskap av huvudsaker, att luftkonditioneringsmodellerna som berörs av denna deklaration innebär att:
- 12 (N) erklærer et fulstændigt ansvar for de luftkonditioneringsmodeller som berøres af denne deklaration indseber at:
- 13 (nb) imoítaha yksinomaan omalla vastuullaan, että tämän ilmoituksen tarkoituksena ilmoitettujen mallien:
- 14 (CZ) prohlašuje ve své plné odpovědnosti, že modely klimatizační, k nimž se toto prohlášení vztahuje:
- 15 (HB) zjavilju pod sklopitov vlastitom odgovornostu, da su modeli klima uređaja na koje se ova izjava odnosi:
- 16 (H) teljes felelősséggel tudatában kijelentem, melyekre e nyilatkozatok vonatkozik.

- 08 estão em conformidade com a(s) seguinte(s) norma(s) ou outro(s) documento(s) normativo(s), desde que estes sejam utilizados de acordo com as nossas instruções;
- 09 соотвествуют следующим стандартам или другим нормативным документам, при условии их использования согласно нашим инструкциям;
- 10 overholder følgende standard(er) eller andet/løsende retningsvisende dokument(er), brudsat at disse anvendes i henhold til vore instruksr.
- 11 respektive utgöring är utförd i överensstämmelse med och tilljer följande standard(er) eller andra normgivande dokument, under förutsättning at användning sker i överensstämmelse med våra instruktionser.
- 12 respektive utşyr er i överensstemmelse med følgende standard(er) eller andre normgivende dokument(er), under forutsettning at disse brukes i henhold til våre instruksr.
- 13 vastaaen seuraavien standardien ja muiden ohjeistettien dokumenttien vaatimuksia edellyttäen, että niitä käytetään ohjeidemme mukaisesti;
- 14 za preporučiti, že isov vuzivati v sosludu s našimi pokyni, odgovaraj nasleđujućim normam nebo normativnim dokumentim;
- 15 u skladu sa slijedećim standardom(na) ili drugim normativnim dokumentom(na), iz uvjet da se oni koriste u skladu s našim uputama;

### Machinery 2006/42/EC \*\* Electromagnetic Compatibility 2014/30/EU \*

- 01 Directives, as amended.
- 02 Direktiven, gemäß Änderung.
- 03 Direktives, telles que modifiées.
- 04 Richtlijnen, zoals gewaenderd.
- 05 Directives, según lo enmendado.
- 06 Direktive, come da modifica.
- 07 Orlvnyv, omuk, şyouv şronomnişē.
- 08 Directives, conforme alteração em.
- 09 Директивe, со вcими поправкам.
- 10 Direktiver, med senere ændringer.
- 11 Direktiv, med foretægta ændring.
- 12 Direktiv, co změne kmenenya.
- 13 Direktiwe, su paplymoms.
- 14 v pñatēm zērtē.
- 15 Smērnice, kako je izmijenio.
- 16 rālyv(ēk) lēš moosistāsak revielvezesāt.
- 17 z pāzņējzymi pōpavikam.
- 18 Directive, co amendamentele respective.
- 19 Direktive, med senere ændringer.
- 20 Direktiv, med foretægta ændring.
- 21 Директив, со текуче изменение.
- 22 Direktiwe, su paplymoms.
- 23 Direktiwa, un lo paplādājumus.
- 24 Smērnice, kako je izmijenio.
- 25 Deģslirīmiz tālrunēleji Foreinmekler.
- 26\*\* Daikin Europe N.V. is authorised to compile the Technical Construction File.
- 27\*\* H. Daikin Europe N.V. siva slobodnoimply na ovovršta, tav Teynikov fobokoa katakoxofu.
- 28\*\* A Daikin Europe N.V. esta autorizada a compilar a documentacia tecnica de fabrico.
- 29\*\* Kompanij Daikin Europe N.V. umovovovena sastaviti Komiterv tehnikovv dokumentaciu.
- 30\*\* Daikin Europe N.V. is authorised to compile the Dossier de Construction Technique.
- 31\*\* Daikin Europe N.V. er autoriseret til at udarbejde de tekniske konstruktionsdata.
- 32\*\* Daikin Europe N.V. er bemyndiget til sammanställa den tekniska konstruktionsfilen.
- 33\*\* Daikin Europe N.V. har tillatelse til å kompilere den Tekniske konstruktionsfilen.
- 34\*\* Daikin Europe N.V. is authorised to compile the Technical Construction File.
- 35\*\* Daikin Europe N.V. hat die Berechtigung die technische Konstruktionsakte zusammenzustellen.
- 36\*\* Daikin Europe N.V. est autorisé à compiler le Dossier de Construction Technique.
- 37\*\* Daikin Europe N.V. is bevoegd om het Technische Constructiebesseer samen te stellen.
- 38\*\* Daikin Europe N.V. está autorizado a compilar el Archivo de Construcción Técnica.
- 39\*\* Daikin Europe N.V. er autorizzata a redigere il File Tecnico di Costruzione.

CE - ATTIKITES-DEKLARACJA  
CE - ATBLĪSTĪBAS-DEKLARACĪJA  
CE - VYHLÁSENIE-ZHODY  
CE - UYUMULULUK-BEYANI

- 17 (EL) deklaruje na vlastnu i vyřaznu odgovornost, že modely klimatizačov, kýmž došlyc nimejšia deklaracija:
- 18 (Sv) dekları je propne řásporedre za aparatele de aer conditionat la care se refera acestá declaratie.
- 19 (CZ) z svo odgovornosti zjavju, řa so modely klimatiskř naprav, na katere sa izjava nanáše:
- 20 (Sv) kmitab om iáet kild vástulsaet, et kássaleva deklaratsioni ále kuluvrad klimaseedemse muidei:
- 21 (Sv) deklarıra na seov otovvorot, če modelere klimatizna instalatıv, za kormo se o mcaer tzvaz deklaravim:
- 22 (LT) vspīše sava ataskomže sleiba, kad oro kondicionavmo prēlasu modeļi, kuriems yra lakoms šī deklaracija:
- 23 (LV) ar pilni atbildi aplēcina, ka iáaku uzskaitito modeļu gāes kondicĩonētāji, uz kuriem attiecas šī deklaracija:
- 24 (Sv) vyhláse na vlastnu zodpovednost, že leto klimatizované modely, na ktoré sa vztáhažu toto vyhlásenie.
- 25 (Tr) lamamen kendı sorumlulúđında olnak izare bu bildirim için oldúđu klima modelleminin asgáđulu gibi olubúđunu beyan eder:

- 16 megjelönek az alábbi szabvány(ok)nak vagy egyéb irányadó dokumentum(ok)nak, ha azokat előírtak szorint használatjuk.
- 17 spnehađa vymoř naseřujujých norm i mých dokumentov normalizačových, pod vátuniken řa zúřvane sa řzodnie z naseřuju mĩ instrukciám;
- 18 sunt în conformitate cu următo(ri) norm(e) standard(e) (sau alte) document(e) normative, cu condiția ca acestea să fie utilizate în conformitate cu instrucțiunile noastre.
- 19 sklađni z naslednjim standardi in drugi normativi, pod pogojem, da se uporabijo v sklađu z našimi navodili:
- 20 on vastastusse järgmiste standarditega või teiste normatiivse dokumentidega, kui neid kasutatakse vastavalt meie juhenditele:
- 21 соотвестват на следните стандарти или други нормативни документи, при условие, че се използват съгласно нашите инструкции;
- 22 atliinka žāmiat nurodytus standartus ir (arba) kitus norminius dokumentus su sąlyga, kad yra naudojami pagal mūsų nurodymus:
- 23 tad, ja letoji atbildis ražoja norādījumiem, abtās sekošoņem standartiem, un citiem normatīviem dokumentiem:
- 24 su v zlođe s naslednivoj(nu)j normo(ma) i(ali) nyr(nu)j(nu)j normativni(m)j dokumento(m)j(ni)j, ře se poživaju v sklādē s našim navodim;
- 25 ūrinat, lai matlamuz gāre kulanimasa kořuljaja asgāđjadi standartiar ve norm beiften beģelate ūyumlidur:

- 10 Direktive, med senere ændringer.
- 11 Direktiv, med foretægta ændring.
- 12 Direktiv, co změne kmenenya.
- 13 Direktiwe, su paplymoms.
- 14 v pñatēm zērtē.
- 15 Smērnice, kako je izmijenio.
- 16 rālyv(ēk) lēš moosistāsak revielvezesāt.
- 17 z pāzņējzymi pōpavikam.
- 18 Directive, co amendamentele respective.
- 19 Direktive, med senere ændringer.
- 20 Direktiv, med foretægta ændring.
- 21 Директив, со текуче изменение.
- 22 Direktiwe, su paplymoms.
- 23 Direktiwa, un lo paplādājumus.
- 24 Smērnice, kako je izmijenio.
- 25 Deģslirīmiz tālrunēleji Foreinmekler.

<A>	DAIKIN.TCF.02.14/07-2016
<B>	DEKRA (NB0344)
<C>	2024351-QUA/E/MC-02-4565

DAIKIN  
3P468238-6

# DAIKIN EUROPE N.V.

## Zandvoordestraat 300, B-8400 Oostende, Belgium

Shigeki Morita  
Director  
Ostend, 2nd of November 2016



**CONTENTS**

	Page
Before installation.....	1
Selecting installation site.....	2
Preparations before installation.....	2
Indoor unit installation.....	3
Refrigerant piping work.....	3
Drain piping work.....	4
Electric wiring work.....	6
Wiring example and how to set the remote controller.....	6
Wiring example.....	7
Installation of the decoration panel.....	8
Test operation.....	8
Wiring diagram.....	9

The English text is the original instruction. Other languages are translations of the original instructions.



**READ THESE INSTRUCTIONS CAREFULLY BEFORE INSTALLATION. KEEP THIS MANUAL IN A HANDY PLACE FOR FUTURE REFERENCE.**

IMPROPER INSTALLATION OR ATTACHMENT OF EQUIPMENT OR ACCESSORIES COULD RESULT IN ELECTRIC SHOCK, SHORT-CIRCUIT, LEAKS, FIRE OR OTHER DAMAGE TO THE EQUIPMENT. BE SURE ONLY TO USE ACCESSORIES MADE BY DAIKIN WHICH ARE SPECIFICALLY DESIGNED FOR USE WITH THE EQUIPMENT AND HAVE THEM INSTALLED BY A PROFESSIONAL.

IF UNSURE OF INSTALLATION PROCEDURES OR USE, ALWAYS CONTACT YOUR DAIKIN DEALER FOR ADVICE AND INFORMATION.

**BEFORE INSTALLATION**







- Leave the unit inside its packaging until you reach the installation site. Where unpacking is unavoidable, use a sling of soft material or protective plates together with a rope when lifting, this to avoid damage or scratches to the unit.
- Refer to the installation manual of the outdoor unit for items not described in this manual.
- Caution concerning refrigerant series R410A:  
The connectable outdoor units must be designed exclusively for R410A.

**Precautions**

- Do not install or operate the unit in rooms mentioned below.
  - Places with mineral oil, or filled with oil vapour or spray like in kitchens. (Plastic parts may deteriorate.)
  - Where corrosive gas like sulphurous gas exists. (Copper tubing and brazed spots may corrode.)
  - Where volatile flammable gas like thinner or gasoline is used.
  - Where machines generating electromagnetic waves exist. (Control system may malfunction.)
  - The unit should be installed at least 2.5 m from the floor.
  - Where the air contains high levels of salt such as air near the ocean and where voltage fluctuates a lot (e.g. in factories). Also in vehicles or vessels.
- Do not install accessories on the casing directly. Drilling holes in the casing may damage electrical wires and consequently cause fire.

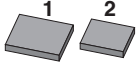
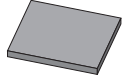
**Accessories**

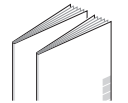
Check if the following accessories are included with your unit.

 Metal clamp 1 piece	 Drain hose 1 piece	 Washer for hanging bracket 8 pieces	 Medium sealing pad 2 pieces
 Large sealing pad 1 piece	Insulation for fitting  for gas pipe 1 piece  for liquid pipe 1 piece		 Installation and operation manual
 Screws for duct flanges 1 set 16 pieces.			 Wire for common power supply 2 pieces.

Screws for fixing panels are attached to the air inlet panel.

**Optional accessories**

- Select an optional remote controller according to customer request and install in an appropriate place. Refer to catalogues and technical literature for selecting a suitable remote controller.
- When installing bottom suction: air inlet panel and canvas connection for the air inlet panel.

**For the following items, take special care during construction and check after installation is finished**

Tick ✓ when checked	
<input type="checkbox"/>	Is the indoor unit fixed firmly? The unit may drop, vibrate or make noise.
<input type="checkbox"/>	Is the gas leak test finished? It may result in insufficient cooling or heating.
<input type="checkbox"/>	Is the unit fully insulated and checked for air leaks? Condensate water may drip.
<input type="checkbox"/>	Does drainage flow smoothly? Condensate water may drip.
<input type="checkbox"/>	Does the power supply voltage correspond to that shown on the name plate? The unit may malfunction or components may burn out.
<input type="checkbox"/>	Are wiring and piping correct? The unit may malfunction or components may burn out.
<input type="checkbox"/>	Is the unit safely grounded? Dangerous at electric leakage.
<input type="checkbox"/>	Is the wiring size according to specifications? The unit may malfunction or components may burn out.
<input type="checkbox"/>	Is nothing blocking the air outlet or inlet of either the indoor or outdoor units? It may result in insufficient cooling or heating.
<input type="checkbox"/>	Are refrigerant piping length and additional refrigerant charge noted down? The refrigerant charge in the system might not be clear. This to avoid confusion for future maintenance and serving of the installation.
<input type="checkbox"/>	Are the air filters fixed properly (when installing with rear duct)? Maintenance of the air filters can be impossible.
<input type="checkbox"/>	Is the external static pressure set? It may result in insufficient cooling or heating.

**Notes to the installer**

- Read this manual carefully to ensure correct installation. Be sure to instruct the customer how to properly operate the system and show him/her the enclosed operation manual.
- Explain to the customer what system is installed on the site. Be sure to fill out the appropriate installation specifications in the chapter "What to do before operation" of the operation manual.

**SELECTING INSTALLATION SITE** (See figure 1 and 2)

- Select an installation site where the following conditions are fulfilled and that meets your customer's approval.
  - Where optimum air distribution can be ensured.
  - Where nothing blocks air passage.
  - Where condensate water can be properly drained.
  - Where the false ceiling is not noticeably on an incline.
  - Where sufficient clearance for maintenance and service can be ensured.
  - Where there is no risk of flammable gas leaking.
  - The equipment is not intended for use in a potentially explosive atmosphere.
  - Where piping between indoor and outdoor units is possible within the allowable limit. (Refer to the installation manual of the outdoor unit.)
  - This is a class A product. In a domestic environment this product may cause radio interference in which case the user may be required to take adequate measures.
  - Keep indoor unit, outdoor unit, power supply wiring and transmission wiring at least 1 meter away from televisions and radios. This is to prevent image interference and noise interference in those electrical appliances. (Electric noise may be generated depending on the conditions under which the electric wave is generated, even if 1 meter is kept.)
  - When installing the wireless remote controller kit, the distance between wireless remote controller and indoor unit might be shorter if there are fluorescent lights who are electrically started in the room. The indoor unit must be installed as far as possible away from fluorescent lights.

- Do not place objects that are susceptible to moisture directly beneath the indoor or outdoor units. Under certain conditions, condensation on the main unit or refrigerant pipes, air filter dirt or drain blockage may cause dripping, resulting in fouling or failure of the object concerned.

- Ensure that a protective guard is installed on air suction and air outlet side to prevent that the fan blades or heat exchanger be touched. The protection must comply with relevant European and national regulations.
- Use suspension bolts for installation. Check whether the ceiling is strong enough to support the weight of the indoor unit. If there is a risk, reinforce the ceiling before installing the unit.

- Service space
- Drain pipe
- Power supply wiring port
- Transmission wiring port
- Maintenance drain outlet
- Gas pipe
- Liquid pipe

**PREPARATIONS BEFORE INSTALLATION**

- Relation of ceiling opening to unit and suspension bolt position. (See figure 5)

A (mm)	B (mm)
1400	1450

- Indoor unit
- Pipe
- Suspension bolt pitch (x4)
- Suspension bolt pitch distance

For installation, choose one of the possibilities as listed further.

**Standard rear suction** (See figure 6a)

- Ceiling surface
- Ceiling opening
- Service access panel (optional accessory)
- Air filter
- Air inlet duct
- Duct service opening
- Interchangeable plate

**Installation with rear duct and duct service opening** (See figure 6b)

**Installation with rear duct, no duct service opening** (See figure 6c)

**NOTE**



Before installation of the unit (in case of installation with duct, but no duct service opening): modify the position of the air filters.

- Remove the air filter(s) at the outside of the unit
- Remove the interchangeable plate
- Install the air filter(s) from the inside of the unit
- Reinstall the interchangeable plate

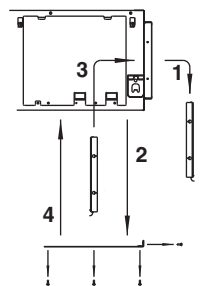

**NOTE** When installing an air inlet duct, select fixing screws that shall stick out maximum 5 mm at the inside of the flange to protect the air filter from damage during maintenance of the filter.



- 1 Air inlet duct
- 2 Inside of the flange
- 3 Fixing screw

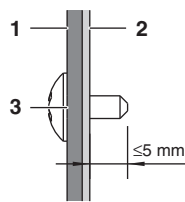

Mounting the air inlet panel with a canvas connection (See figure 7a)

Mounting the air inlet panel directly (See figure 7b)

- 1 Ceiling surface
- 2 Ceiling opening
- 3 Air inlet panel (Optional accessory)
- 4 Indoor unit (Back side)
- 5 Canvas connection for air inlet panel (Optional accessory)

A (mm)
1460

Bottom suction (See figure 7c)

**NOTE** The unit can be used with bottom suction by replacing the interchangeable plate by the air filter holding plate.



- 1 Air filter holding plate with air filter(s)
- 2 Interchangeable plate

**NOTE** For other installation than standard installation, contact your Daikin dealer for details.



2. The fan speed for this indoor unit is preset to provide standard external static pressure. If higher or lower external static pressure is required, reset the external static pressure by changing the initial setting from the remote controller. Refer to "External static pressure setting" on page 7.
3. Install the suspension bolts. (Use M10 size bolt for the suspension bolt.) Use anchors for existing ceilings, and a sunken insert, sunken anchors or other field supplied parts for new ceilings to reinforce the ceiling in order to bear the weight of the unit.

*Installation example*

(See figure 3)

- 1 Anchor
- 2 Ceiling slab
- 3 Long nut or turn-buckle
- 4 Suspension bolt
- 5 Indoor unit

**NOTE** All the above parts are field supplied.



## INDOOR UNIT INSTALLATION

When installing optional accessories (except for the air inlet panel), read also the installation manual of the optional accessories. Depending on the field conditions, it may be easier to install optional accessories before the indoor unit is installed.

1. Install the indoor unit temporarily.
  - Attach the hanger bracket to the suspension bolt. Be sure to fix it securely by using a nut and washer from the upper and lower sides of the hanger bracket. (See figure 4)
- 1 Nut (field supply)
- 2 Washer for hanger bracket (supplied with the unit)
- 3 Tighten (double nut)
2. Check if the unit is horizontally levelled.
  - Do not install the unit tilted. The indoor unit is equipped with a built-in drain pump and float switch. (If the unit is tilted against condensate flow, the float switch may malfunction and cause water to drip.)
  - Check if the unit is levelled at all four corners with a water level or a water-filled vinyl tube as shown in figure 9.
- 1 Water level
- 2 Vinyl tube
3. Tighten the upper nut.

## REFRIGERANT PIPING WORK

For refrigerant piping of outdoor unit, refer to the installation manual supplied with the outdoor unit.

Execute heat insulation work completely on both sides of the gas piping and the liquid piping. Otherwise, this can sometimes result in water leakage.

Before rigging tubes, check which type of refrigerant is used.



All field piping must be provided by a licensed refrigeration technician and must comply with the relevant local and national codes.

- Use a pipe cutter and flare suitable for the used refrigerant.
- To prevent dust, moisture or other foreign matter from infiltrating the tube, either pinch the end, or cover it with tape.
- Use copper alloy seamless pipes (ISO 1337).
- The outdoor unit is charged with refrigerant.
- To prevent water leakage, execute heat insulation work completely on both sides of the gas and liquid piping. When using a heat pump, the temperature of the gas piping can reach up to approximately 120°C, use insulation which is sufficiently heat resistant.
- Be sure to use both a spanner and torque wrench together when connecting or disconnecting pipes to/from the unit.

- 1 Torque wrench
- 2 Spanner
- 3 Piping union
- 4 Flare nut

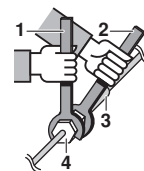

- Do not mix anything other than the specified refrigerant, such as air, etc..., inside the refrigerant circuit.
- Use annealed material only for flare connections.

- Refer to [Table 1](#) for the dimensions of flare nut spaces and the appropriate tightening torque. (Overtightening may damage the flare and cause leaks.)

Table 1

Pipe gauge	Tightening torque (N·m)	Flare dimension A (mm)	Flare shape
Ø6.4	15~17	8.7~9.1	
Ø9.5	33~39	12.8~13.2	
Ø12.7	50~60	16.2~16.6	
Ø15.9	63~75	19.3~19.7	

- When connecting the flare nut, coat the flare inner surface with ether oil or ester oil and initially tighten 3 or 4 turns by hand before tightening firmly.

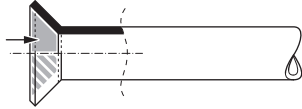

- If the refrigerant gas leaks during the work, ventilate the area. A toxic gas is emitted by the refrigerant gas being exposed to a fire.
- Make sure there is no refrigerant gas leak. A toxic gas may be released by the refrigerant gas leaking indoor and being exposed to flames from an area heater, cooking stove, etc.
- Finally, insulate as shown in the figures below.

### Piping insulation procedure

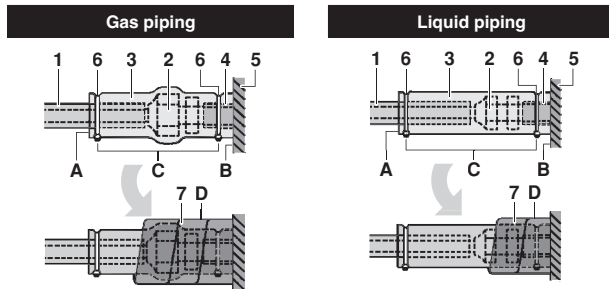

- Piping insulation material (field supply)
  - Flare nut connection
  - Insulation for fitting (delivered with the unit)
  - Piping insulation material (main unit)
  - Main unit
  - Clamp (field supply)
  - Medium 1 sealing pad for gas piping (delivered with the unit)  
Medium 2 sealing pad for liquid piping (delivered with the unit)
- A Turn seams up  
B Attach to base  
C Tighten the part other than the piping insulation material  
D Wrap over from the base of the unit to the top of the flare nut connection



For local insulation, be sure to insulate local piping all the way into the pipe connections inside the unit. Exposed piping may cause condensation or may cause burns when touched.

### Cautions for brazing

- Be sure to carry out a nitrogen blow when brazing. Brazing without carrying out nitrogen replacement or releasing nitrogen into the piping will create large quantities of oxidized film on the inside of the pipes, adversely affecting valves and compressors in the refrigerating system and preventing normal operation.
- When brazing while inserting nitrogen into the piping, nitrogen must be set to 0.02 MPa with a pressure-reducing valve (=just enough so that it can be felt on the skin).

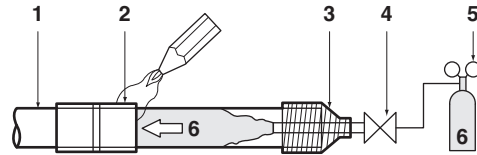

- Refrigerant piping
- Part to be brazed
- Taping
- Hands valve
- Pressure-reducing valve
- Nitrogen

### DRAIN PIPING WORK

Rig the drain piping as shown in the figure and take measures against condensation. Improperly rigged piping could lead to leaks and eventually wet furniture and belongings.

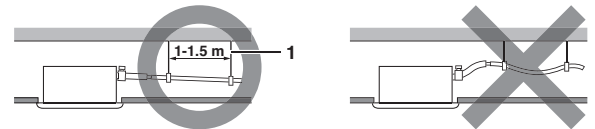

- Hanging bar

- Install the drain pipes.
  - Keep piping as short as possible and slope it downwards at a gradient of at least 1/100 so that air may not remain trapped inside the pipe.
  - Keep pipe size equal to or greater than that of the connecting pipe (vinyl pipe of 25 mm nominal diameter and 32 mm outer diameter).
  - Push the supplied drain hose as far as possible over the drain socket.
  - Tighten the metal clamp until the screw head is less than 4 mm from the metal clamp part as indicated in the illustration.

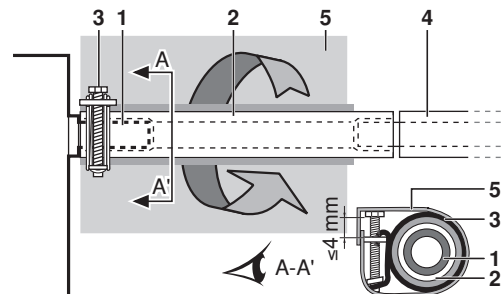

- Drain socket (attached to the unit)
- Drain hose (supplied with the unit)
- Metal clamp (supplied with the unit)
- Drain piping (field supply)
- Large sealing pad (supplied with the unit)

- Wrap the supplied large sealing pad over the metal clamp and drain hose to insulate and fix it with clamps.

- Insulate the complete drain piping inside the building (field supply).
- If the drain hose cannot be sufficiently set on a slope, fit the hose with drain raising piping (field supply).

#### ■ How to perform drain piping

(See figure 10)

- 1 Ceiling slab
- 2 Hanger bracket
- 3 Adjustable range
- 4 Drain raising pipe
- 5 Drain hose (supplied with the unit)
- 6 Clamp metal (supplied with the unit)

- 1 Connect the drain hose to the drain raising pipes, and insulate them.
- 2 Connect the drain hose to the drain outlet on the indoor unit, and tighten it with the clamp.

Installation	A (mm)
Rear suction installation	231
When canvas duct is installed	350-530
When air inlet panel is directly installed	231

#### ■ Precautions

- Install the drain raising pipes at a height of less than 625 mm.
- Install the drain raising pipes at a right angle to the indoor unit and no more than 300 mm from the unit.
- To prevent air bubbles, install the drain hose level or slightly tilted up ( $\leq 75$  mm).

#### NOTE



The incline of attached drain hose should be 75 mm or less so that the drain socket does not have to withstand additional force.

To ensure a downward slope of 1:100, install hanging bars every 1 to 1.5 m.

When unifying multiple drain pipes, install the pipes as shown in figure 11. Select converging drain pipes whose gauge is suitable for the operating capacity of the unit.

- 1 T-joint converging drain pipes

### Testing of drain piping

After piping work is finished, check if drainage flows smoothly.

- Add approximately 1 l of water gradually through the air discharge outlet. Check for water leaks. Method of adding water. See figure 8.

- 1 Water inlet
- 2 Portable pump
- 3 Water inlet cover
- 4 Bucket (adding water through water inlet)
- 5 Drain outlet for maintenance (with rubber drain plug)
- 6 Refrigerant pipes



#### Caution for drain socket

Do not remove the drain pipe plug. Water might leak out.

The drain outlet is only used to discharge water if the drain pump is not used or before maintenance. Gently put in and out the drain plug. Excessive force may deform the drain socket of the drain pan.

#### ■ Pulling out the plug

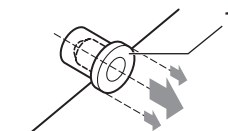

1 Drain plug

Do not wiggle the plug up and down

#### ■ Pushing in the plug

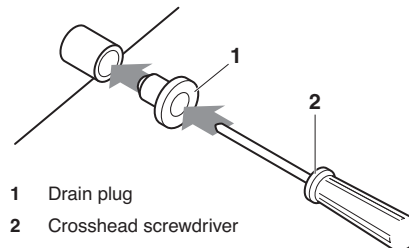

1 Drain plug

2 Crosshead screwdriver

Set the plug and push it by using a crosshead screwdriver

First perform electric wiring work as instructed in "Electric wiring work" on page 6 and how to set the remote controller as explained in "Wiring example and how to set the remote controller" on page 6.

#### When electric wiring work is finished

Check drainage flow during COOL running, explained in "Test operation" on page 8.

#### When electric wiring work is not finished

- Remove the switch box cover and connect the single-phase power supply and the remote controller to the terminals. (Refer to chapter "Electric wiring work" on page 6 for switch box attachment/detachment) (Refer to figure 12 and 13)

- Connect the single-phase power supply to connections 1 and 2 (as shown in the figure) on the power supply terminal board and confirm drain operation.

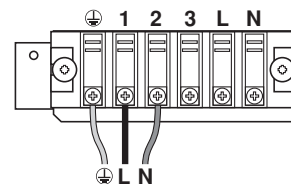

- Be aware that the fan will turn during the operation.
- After confirming drainage, turn off the power.

- 1 Switch box cover
- 2 Transmission wiring port
- 3 Power supply wiring port
- 4 Wiring diagram
- 5 Switch box
- 6 Plastic clamp
- 7 Remote controller wiring
- 8 Terminal board for unit transmission wiring
- 9 Power supply wiring
- 10 Indoor PCB board 1
- 11 Power supply terminal board
- 12 Transmission wiring between units
- 13 Indoor PCB board 2
- 14 Indoor PCB board 3 (only for 60~140 units)



# ELECTRIC WIRING WORK

## General instructions

- All field supplied parts and materials and electric works must conform to local codes.
- Use copper wire only.
- Follow the "Wiring diagram" attached to the unit body to wire the outdoor unit, indoor units and the remote controller. For details on hooking up the remote controller, refer to the "Installation manual of the remote controller".
- All wiring must be performed by an authorized electrician.
- Attach the earth leakage circuit breaker and fuse to the power supply line.
- A main switch or other means for disconnection, having a contact separation in all poles, must be incorporated in the fixed wiring in accordance with relevant local and national legislation. Note that the operation will restart automatically if the main power supply is turned off and then turned back on again.
- Refer to the installation manual delivered with the outdoor unit for the size of power supply electric wire connected to the outdoor unit, the capacity of the earth leakage breaker and fuse and for wiring instructions.
- Be sure to ground the air conditioner.
- Do not connect the ground wire to:
  - gas pipes: might cause explosions or fire if gas leaks.
  - telephone ground wires or lightning rods: might cause abnormally high electric potential in the ground during lightning storms.
  - plumbing pipes: no grounding effect if hard vinyl piping is used.
- Make sure electrical wires are stripped equally. 

## Electrical characteristics

Hz	Volts	Voltage range	Power supply	
			MCA	MFA
50/60	220-240/220	±10%	2.9	16 A

MCA: Min. circuit Amps (A)  
MFA: Max. Fuse Amps (A)

**NOTE** For details, refer to "Electrical data" in the technical data book. 

## Specifications for field wire

	Wire	Size (mm <sup>2</sup> )	Length
Between indoor units	H05VV-U4G <sup>(a),(b)</sup>	2.5	—
Unit-Remote controller	Sheathed wire (2 wire) <sup>(c)</sup>	0.75–1.25	Max. 500 m <sup>(d)</sup>

- (a) Shows only in case of protected pipes. Use H07RN-F in case of no protection.
- (b) Run transmission wiring between the indoor and outdoor units through a conduit to protect against external forces, and feed the conduit through the wall together with refrigerant piping.
- (c) Use double insulation wire for remote controller (sheath thickness: ≥1 mm) or run wires through a wall or conduit so that the user cannot come in contact with them.
- (d) This length shall be the total extended length in the system of the group control.

# WIRING EXAMPLE AND HOW TO SET THE REMOTE CONTROLLER

## How to connect wiring

Remove the switch box cover as shown in figure 13, and make the connections.

- 1 Switch box cover
- 2 Switch box low voltage wiring inlet
- 3 Switch box high voltage wiring inlet
- 4 Wiring diagram
- 5 Switch box

## Precautions

1. Observe the notes mentioned below when wiring to the power supply terminal board.

- Use a round crimp-style terminal for insulation sleeve for connection to the terminal block for wiring the units. When none are available, follow the instructions below.

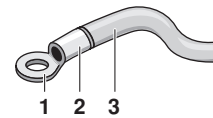

- 1 Round crimp-style terminal
- 2 Attach insulation sleeve
- 3 Wiring

- Do not connect wires of different gauge to the same power supply terminal. (Looseness in the connection may cause overheating.)
- When connecting wires of the same gauge, connect them according to the figure.



Use the specified electric wire. Connect the wire securely to the terminal. Lock the wire down without applying excessive force to the terminal. Use torques according to the table below.

Tightening torque (N·m)	
Terminal block for unit transmission and remote controller	0.9
Terminal block for power supply	1.2

- When attaching the control box lid, make sure not to pinch any wires.
  - After all wiring connections are done, fill in any gaps in the casing wiring holes with putty or insulation material (field supply) thus to prevent small animals or dirt from entering the unit from outside and causing short circuits in the control box.
2. Do not connect wires of different gauge to the same grounding terminal. Looseness in the connection may deteriorate the protection.
  3. Remote controller cords and wires connecting the units should be located at least 50 mm away from power supply wiring. Not following this guideline may result in malfunction due to electrical noise.
  4. For the remote controller wiring, refer to the "Installation manual of the remote controller" supplied with the remote controller.

**NOTE** The customer has the ability to select the remote controller thermistor. 

5. Never connect the power supply wiring to the terminal board for transmission wiring. This mistake could damage the entire system.
6. Use only specified wires and tightly connect wires to the terminals. Be careful that wires do not place external stress on the terminals. Keep wiring in neat order so that they do not obstruct other equipment such as popping open the switch box cover. Make sure the cover closes tight. Incomplete connections could result in overheating, and in the worse case, electric shock or fire.

## WIRING EXAMPLE

- Fit the power supply wiring of each system with a switch and fuse as shown in figure 14 and figure 15.

- Power supply
- Main switch
- Fuse
- Outdoor unit
- Indoor unit
- Remote controller (optional accessory)

### Complete system example (3 systems)

When using 1 remote controller for 1 indoor unit. (Normal operation) (See figure 14 and figure 15)

Use with 2 remote controllers (See figure 16)<sup>(a)</sup>

For group control (See figure 17)<sup>(a)</sup>

#### NOTE



It is not necessary to designate an indoor unit address when using group control. The address is automatically set when the power is activated.

#### NOTE



To comply with EN/IEC 61000-3-12<sup>(b)</sup>, following rules must be considered:

- If the combination of units is one of the following, use separate power supplies. (See figure 15)

2x FDQ125C + RZQ250C

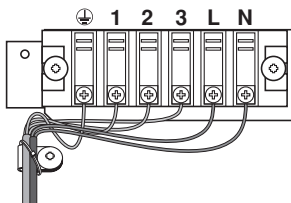

- Otherwise, refer to the table with  $S_{sc}$  (short-circuit power) values for FDQ\_C combinations, to be found on the extranet.

- If no  $S_{sc}$  value is mentioned in the table for the used combination, the common power supply wire delivered with the unit can be used. (See figure 14)
- If a  $S_{sc}$  value is mentioned in the table for the used combination, either the common power supply wire delivered with the unit (see figure 14) or separate power supplies (see figure 15) can be used. Daikin recommends to use separate power supplies.

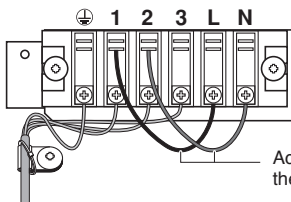

Refer to the wiring diagram for connections. For more details, refer to the electrical data.

- (a) Shown in figure is with common power supply  
 (b) European/International Technical Standard setting the limits for harmonic currents produced by equipment connected to low-voltage systems with input current >16 A and ≤75 A per phase.

## Precautions

- A single switch can be used to supply power to units on the same system. However, branch switches and branch circuit breakers must be selected carefully.
- For a group control remote controller, choose the remote controller that suits the indoor unit which has the most functions.

## Field setting

Field setting must be made from the remote controller in accordance with the installation condition.

- Setting can be made by changing the "Mode number", "FIRST CODE No." and "SECOND CODE No.".
- For setting and operation, refer to "Field setting" in the installation manual of the remote controller.

## Setting for optional accessories

In case of connecting optional accessories, refer to the operation manuals provided with the optional accessories and establish necessary settings.

## External static pressure setting

Settings for external static pressure can be achieved in 2 ways:

### Using the airflow automatic adjustment function

Airflow automatic adjustment is the volume of blow-off air that has been automatically adjusted to the rated quantity.

- Make sure the test run is done with a dry coil.  
If the coil is not dry, run the unit for 2 hours with fan only to dry the coil.
- Check if the power supply wiring to the air conditioning unit is completed along with the duct installation.  
If a closing damper is installed in the air conditioning unit, make sure that it is open.  
Also check if the air filter is properly attached into the air passage on the air suction side of the air conditioning unit.
- If there is more than one air inlet and outlet, adjust the dampers so that the airflow rate of each air inlet and outlet is conform with the designed airflow rate.  
Make sure the air conditioning unit is in fan operation mode. Press and set the airflow adjustment button on the remote controller to change the airflow rate to H or L.
- Setting the airflow automatic adjustment settings.

When the air conditioning unit is running in fan operation mode perform the next steps:

- stop the air conditioning unit,
- go to field setting mode,
- select mode No. 21 (or 11 in case of group setting),
- set the first code No. to "7",
- set the second code No. to "03".

Return to normal operating mode after setting these settings and press the ON/OFF operation button. The operation lamp will light up and the air conditioning unit will start the fan operation for airflow automatic adjustment.



Do not adjust the dampers during fan operation for airflow automatic adjustment.

After 1 to 8 minutes, the air conditioning unit stops operating automatically when the fan operation for airflow automatic adjustment has been carried out, the operation lamp will be off.

Mode No.	First code No.	Second code No.	Setting content
11 (21)	7	01	Airflow adjustment is OFF
		02	Completion of airflow adjustment
		03	Start of airflow adjustment

- 5 When the air conditioning unit has stopped, check on an indoor unit if the second code No. of mode No. 21 is set to "02".

If the air conditioning unit does not stop operating or the second code No. is not "02", repeat step 4.

If the outdoor unit is not turned on, the display on the remote controller will show "㊦" or "㊧" (refer to "Test operation" on page 8). However, you can continue setting this function because these messages are only applicable to outdoor units.

After setting this function, be sure to turn on the outdoor unit before performing the test operation on the outdoor unit.

If any other error display occurs on the display of the remote controller, refer to "Test operation" on page 8 and the operation manual of the outdoor unit. Check the defective point.



- If there is no change after airflow adjustment in the ventilation paths, be sure to perform setting the automatic airflow adjustment again.
- Contact your dealer if there is no change after performing airflow adjustment in the ventilation paths, after performing the test operation of the outdoor unit or when the air conditioning unit is moved to another location.
- If booster fans, an outdoor air processing unit or HRV via duct are used, do not use automatic airflow adjustment control with a remote controller.
- If the ventilation paths have been changed, perform the setting of the airflow automatic adjustment again as described above from step 3 onwards.

### Using the remote controller

Check on an indoor unit if the second code of mode No. 21 is set to "01" (= factory setting). Change the second code according to the external static pressure of the duct to be connected as shown in table 2.

**NOTE** The second code No. is set to "02" by default.



Table 2

Mode No.	First code No.	Second code No.	External static pressure (Pa)
13 (23)	6	01	40
		02	50
		03	60
		04	70
		05	80
		06	90
		07	100
		08	110
		09	120
		10	130
		11	140
		12	150
		13	160
		14	180
		15	200

### Setting air filter sign

- Remote controllers are equipped with liquid crystal display air filter signs to display the time to clean air filters.
- Change the SECOND CODE No. According to Table 3 depending on the amount of dirt or dust in the room. (SECOND CODE No. Is factory set to "01" for filter contamination-light.)

Table 3

Setting	Spacing time of display air filter sign (long life type)	Mode No.	First code No.	Second code No.
Air filter contamination - light	±2500 hrs	10 (20)	0	01
Air filter contamination - heavy	±1250 hrs			02

### Control by 2 Remote Controllers (Controlling 1 indoor unit by 2 remote controllers)

When using 2 remote controllers, one must be set to "MAIN" and the other to "SUB".

### INSTALLATION OF THE DECORATION PANEL

Refer to the installation manual attached to the decoration panel.

After installing the decoration panel, ensure that there is no space between the unit body and decoration panel.

### TEST OPERATION

Refer to the section of "For the following items, take special care during construction and check after installation is finished" on page 2.

- After finishing the construction of refrigerant piping, drain piping, and electric wiring, conduct test operation accordingly to protect the unit.
- 1 Open the gas side stop valve.
  - 2 Open the liquid side stop valve.
  - 3 Electrify crank case heater for 6 hours.
  - 4 Set to cooling operation with the remote controller and start operation by pushing ON/OFF button.
  - 5 Press Inspection/Test Operation button 4 times and operate at Test Operation mode for 3 minutes.
  - 6 Press Inspection/Test Operation button and operate normally.
  - 7 Confirm function of unit according to the operation manual.

**NOTE**



If the main power supply is turned off during operation, operation will restart automatically after the power turns back on again.

# WIRING DIAGRAM

--■□■--	: FIELD WIRING
⊞	: CONNECTOR
●	: WIRE CLAMP
⊕	: PROTECTIVE EARTH (SCREW)
L	: LIVE
N	: NEUTRAL

BLK	: BLACK	ORG	: ORANGE
BLU	: BLUE	PNK	: PINK
BRN	: BROWN	RED	: RED
GRN	: GREEN	WHT	: WHITE
GRY	: GREY	YLW	: YELLOW

A1P	..... PRINTED CIRCUIT BOARD
A2P	..... PRINTED CIRCUIT BOARD (FAN)
A3P	..... PRINTED CIRCUIT BOARD (CAPACITOR) (only for 60~140 units)
C1,C2,C3	..... CAPACITOR
F1U,F2U	..... FUSE (T, 5 A, 250 V)
F3U,F4U	..... FUSE (T, 6.3 A, 250 V)
HAP	..... LIGHT EMITTING DIODE (SERVICE MONITOR - GREEN)
KPR,K1R	..... MAGNETIC RELAY
L1R	..... REACTOR
M1F	..... MOTOR (FAN)
M1P	..... MOTOR (DRAIN PUMP)
PS	..... SWITCHING POWER SUPPLY
Q1DI	..... EARTH LEAK DETECTOR
RC	..... SIGNAL RECEIVER CIRCUIT
R1	..... RESISTOR (CURRENT LIMITING)
R2	..... CURRENT SENSING DEVICE
R3,R4	..... RESISTOR (ELECTRIC DISCHARGE)
R1T	..... THERMISTOR (SUCTION AIR)
R2T	..... THERMISTOR (LIQUID)

R3T	..... THERMISTOR (GAS)
R5T	..... THERMISTOR NTC (CURRENT LIMITING)
SS1	..... SELECTOR SWITCH (EMERGENCY)
S1L	..... FLOAT SWITCH
TC	..... SIGNAL TRANSMISSION CIRCUIT
V1R	..... DIODE BRIDGE
V2R	..... POWER MODULE
X1M	..... TERMINAL STRIP (POWER SUPPLY)
X2M	..... TERMINAL STRIP (CONTROL)
Z1C	..... NOISE FILTER (FERRITE CORE)
Z1F	..... NOISE FILTER

### CONNECTOR OPTIONAL ACCESSORY

X28A	..... CONNECTOR (POWER SUPPLY FOR WIRING)
X33A	..... CONNECTOR (FOR WIRING)
X35A	..... CONNECTOR (ADAPTOR)

### WIRED REMOTE CONTROLLER

R1T	..... THERMISTOR (AIR)
SS1	..... SELECTOR SWITCH (MAIN/SUB)

WIRED REMOTE CONTROLLER	:
(OPTIONAL ACCESSORY)	:
SWITCH BOX (INDOOR)	:
TRANSMISSION WIRING	:
CENTRAL REMOTE CONTROLLER	:
INPUT FROM OUTSIDE	:
COMMON POWER SUPPLY	:

### NOTE



1. USE COPPER CONDUCTORS ONLY.
2. WHEN USING THE CENTRAL REMOTE CONTROLLER, SEE MANUAL FOR CONNECTION TO THE UNIT.
3. WHEN CONNECTING THE INPUT WIRES FROM OUTSIDE, FORCED "OFF" OR "ON/OFF" CONTROL OPERATION CAN BE SELECTED BY THE REMOTE CONTROLLER. SEE INSTALLATION MANUAL FOR MORE DETAILS.
4. REFER TO INSTALLATION MANUAL.

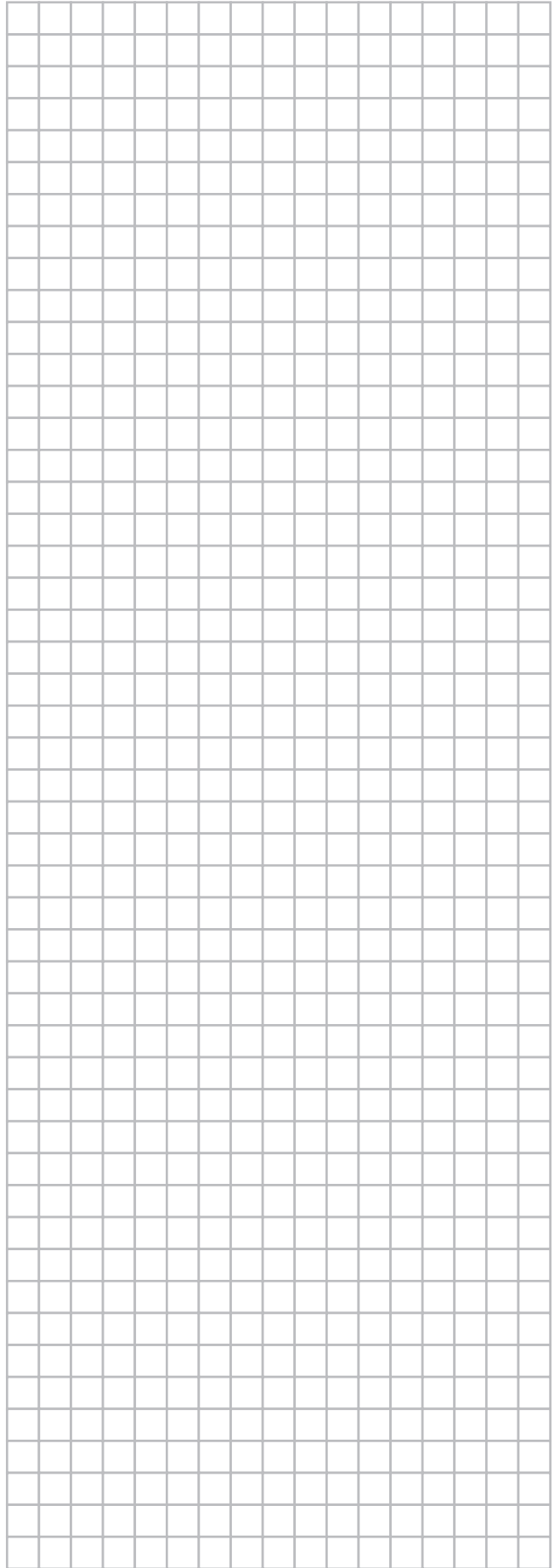
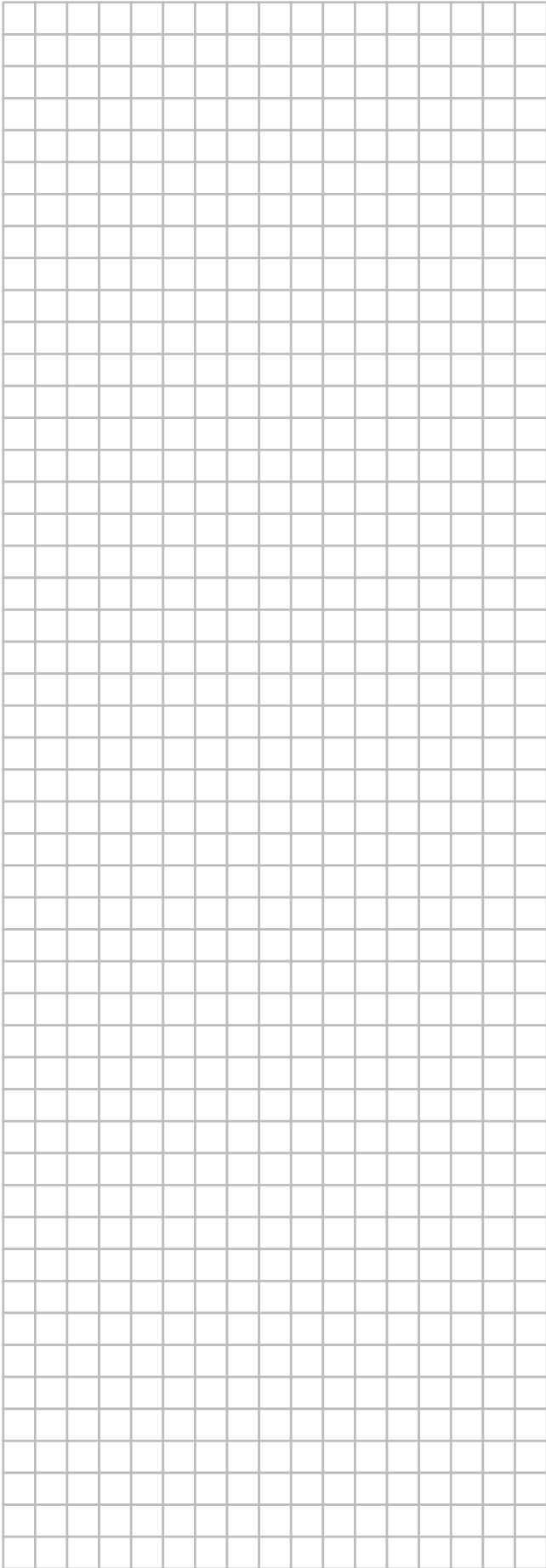

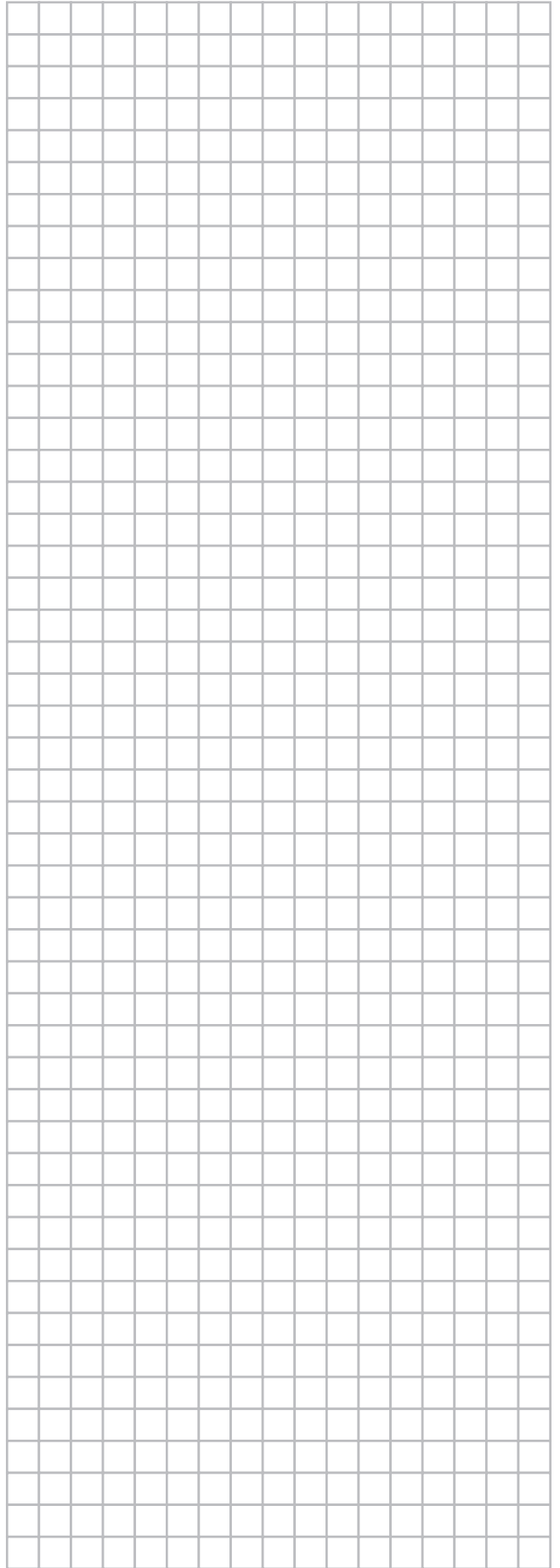
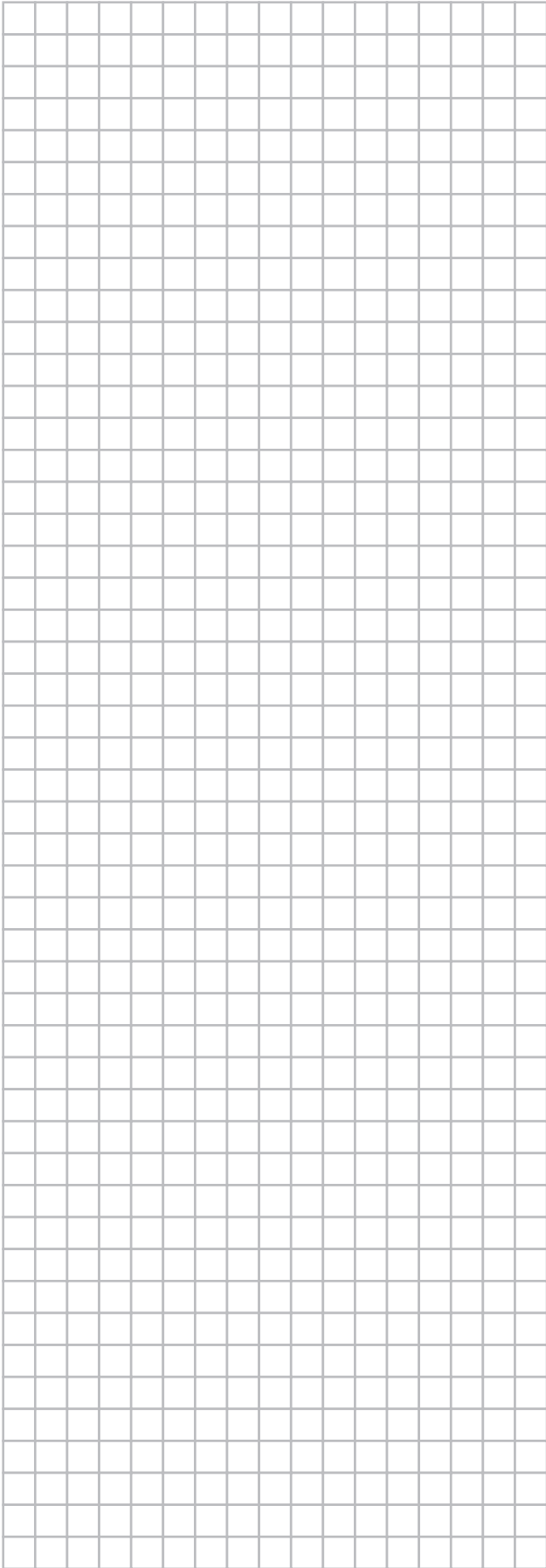

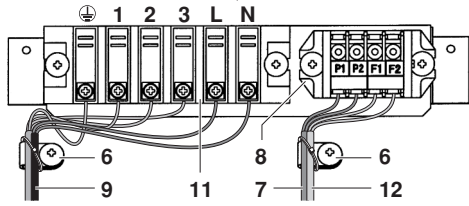
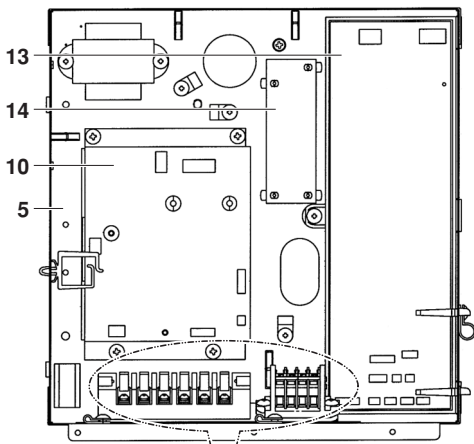

12

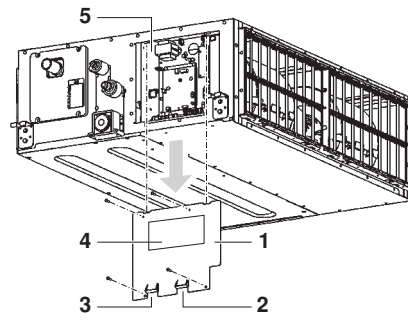

13

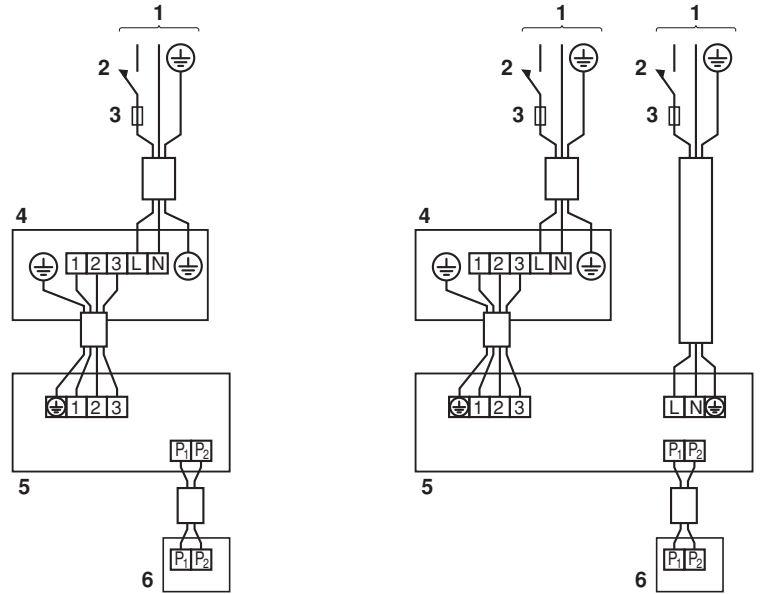

14

15

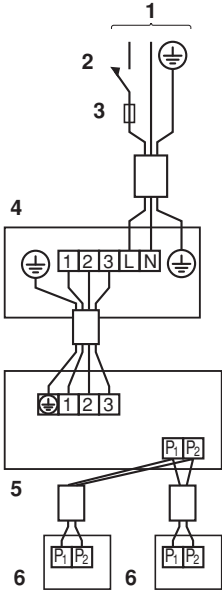

16

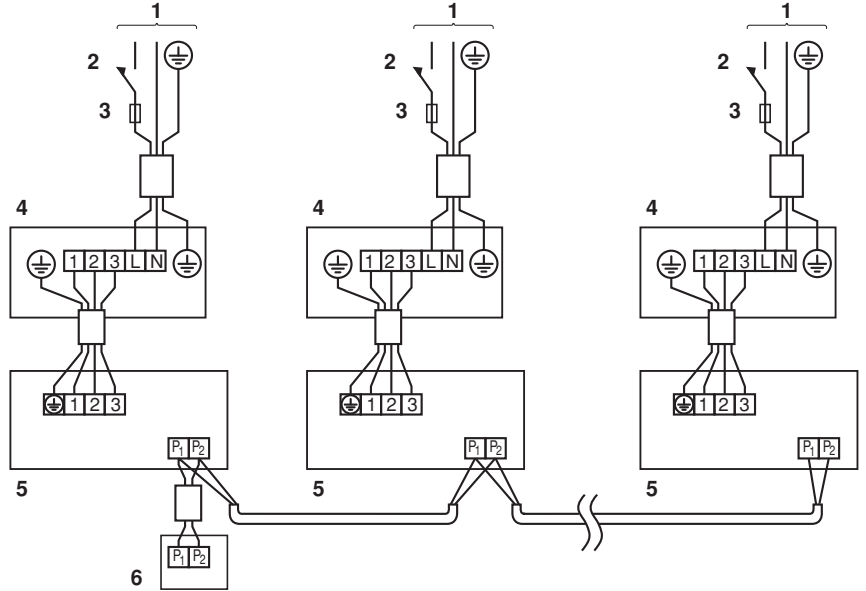

17

**EAC**

Copyright 2016 © Daikin

**DAIKIN EUROPE N.V.**

Zandvoordestraat 300, B-8400 Oostende, Belgium

3P468515-6 12.2016