

# Configuration reference guide MMI user interface

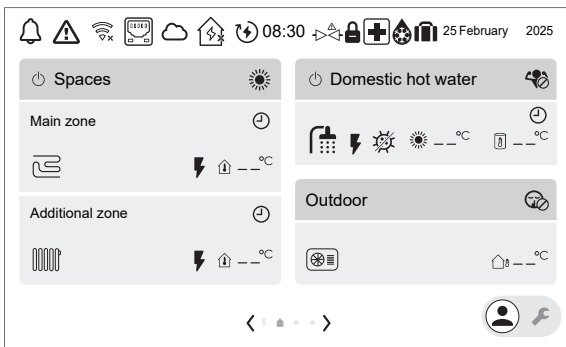

# Table of contents

<b>1</b>	<b>About this document</b>	<b>6</b>
<b>2</b>	<b>Possible screens: Overview</b>	<b>7</b>
2.1	Home screen .....	7
2.2	Energy flow – System overview screen.....	10
2.3	Main menu screen.....	12
2.4	Setpoint screen.....	13
<b>3</b>	<b>Schedules</b>	<b>14</b>
3.1	Using and programming schedules.....	14
3.2	Schedule screen: Example.....	20
<b>4</b>	<b>Weather-dependent curve</b>	<b>26</b>
4.1	What is a weather-dependent curve? .....	26
4.2	Using weather-dependent curves.....	26
<b>5</b>	<b>Energy prices</b>	<b>29</b>
5.1	Energy price considered.....	29
5.2	To set the fixed electricity price (no scheduling).....	29
5.3	To set the scheduled electricity baseline price .....	30
5.4	To set the electricity price schedule .....	30
5.5	To set the gas price .....	30
5.6	About energy prices in case of an incentive per kWh renewable energy.....	31
5.6.1	To set the gas price in case of an incentive per kWh renewable energy .....	31
5.6.2	To set the electricity price in case of an incentive per kWh renewable energy .....	31
5.6.3	Example.....	31
<b>6</b>	<b>Domestic hot water control</b>	<b>32</b>
6.1	To determine the domestic hot water control .....	32
6.2	Reheat mode with fixed setpoint.....	32
6.3	Schedule and reheat mode .....	34
6.4	Scheduled mode.....	35
6.5	Reheat mode with scheduled setpoints .....	36
6.6	Single heat-up.....	37
6.6.1	Manual mode.....	37
6.6.2	Powerful heating mode .....	37
6.7	Additional heat source for DHW .....	38
<b>7</b>	<b>Modbus TCP/IP for Daikin Altherma</b>	<b>40</b>
7.1	Modbus protocol.....	40
7.2	Modbus registers.....	40
7.2.1	Holding registers .....	42
7.2.2	Input registers .....	45
7.2.3	Discrete input registers.....	49
7.2.4	Coil registers .....	49
7.3	Modbus TCP/IP for Daikin Altherma .....	50
7.4	Third-party Modbus integrations.....	50
7.5	Smart Grid for utilities.....	50
7.6	Energy buffering with Smart Grid .....	51
<b>8</b>	<b>Cloud for Daikin Altherma</b>	<b>55</b>
8.1	Third-party Cloud integrations.....	55
<b>9</b>	<b>Other functionalities</b>	<b>58</b>
9.1	To set Time/date .....	58
9.2	Using quiet mode .....	58
9.3	Using holiday mode.....	60
9.4	Using WLAN.....	61
9.5	Using LAN.....	63
<b>10</b>	<b>Settings</b>	<b>66</b>
[1]	Main zone.....	66
[1.1]	Room setpoint.....	66
[1.2]	Heating schedule enable .....	67
[1.3]	Heating schedule .....	67
[1.4]	Cooling schedule .....	68
[1.5]	Heating setpoint mode.....	68

[1.6] Setpoint range: Heating / [1.43] Setpoint range: Cooling.....	68
[1.7] Cooling setpoint mode.....	71
[1.8] Heating WD curve.....	71
[1.9] Cooling WD curve.....	72
[1.10] Hysteresis.....	72
[1.11] Emitter type.....	73
[1.12] Control.....	74
[1.13] External room thermostat.....	74
[1.14] Delta T heating.....	75
[1.15] NOT USED.....	76
[1.16] Cooling allowance.....	76
[1.17] Enable zone.....	77
[1.18] Delta T cooling.....	77
[1.19] Overheating water circuit.....	77
[1.20] Undercooling water circuit.....	78
[1.21] Zone name.....	78
[1.22] Antifrost.....	78
[1.23] Cooling schedule enable.....	79
[1.24] Leaving water shift heating schedule.....	79
[1.25] Leaving water shift cooling schedule.....	80
[1.26] Increase around 0°C.....	81
[1.27] Leaving water shift heating.....	81
[1.28] Leaving water shift cooling.....	81
[1.29] Heating comfort setpoint.....	81
[1.30] Cooling comfort setpoint.....	82
[1.31] Daikin room thermostat.....	82
[1.32] Room enable.....	82
[1.33] External room sensor offset.....	83
[1.34] Heating target baseline.....	83
[1.35] Cooling target baseline.....	83
[1.36] Scheduled WD LWT shift for heating.....	83
[1.37] Scheduled WD LWT shift for cooling.....	84
[1.38] Thermostat sensor offset.....	84
[1.39] Leaving water temp. heating.....	84
[1.40] NOT USED.....	84
[1.41] NOT USED.....	84
[1.42] Leaving water temp. cooling.....	84
[1.43] Setpoint range: Cooling.....	85
[2] Additional zone.....	86
[2.1] NOT USED.....	86
[2.2] Heating schedule enable.....	86
[2.3] Heating schedule.....	87
[2.4] Cooling schedule.....	87
[2.5] Heating setpoint mode.....	87
[2.6] Setpoint range: Heating / [2.37] Setpoint range: Cooling.....	88
[2.7] Cooling setpoint mode.....	90
[2.8] Heating WD curve.....	90
[2.9] Cooling WD curve.....	91
[2.10] NOT USED.....	91
[2.11] Emitter type.....	91
[2.12] Control.....	92
[2.13] External room thermostat.....	92
[2.14] Delta T heating.....	93
[2.15] Enable zone.....	94
[2.16] NOT USED.....	94
[2.17] Delta T cooling.....	94
[2.18] Leaving water shift heating schedule.....	94
[2.19] Leaving water shift cooling schedule.....	95
[2.20] Increase around 0°C.....	96
[2.21] Zone name.....	96
[2.22] Leaving water shift heating.....	96
[2.23] Leaving water shift cooling.....	96
[2.24] NOT USED.....	97
[2.25] NOT USED.....	97
[2.26] NOT USED.....	97
[2.27] Cooling schedule enable.....	97
[2.28] NOT USED.....	97
[2.29] NOT USED.....	97
[2.30] Leaving water temp. heating.....	97

[2.31] Scheduled WD LWT shift for heating.....	97
[2.32] Scheduled WD LWT shift for cooling.....	98
[2.33] Cooling allowance.....	98
[2.34] NOT USED.....	98
[2.35] NOT USED.....	98
[2.36] Leaving water temp. cooling.....	98
[2.37] Setpoint range: Cooling.....	98
[3] Heating/cooling.....	99
[3.1] Operation allowance: Heating / [3.16] Operation allowance: Cooling.....	99
[3.2] Operation mode.....	99
[3.3] NOT USED.....	101
[3.4] Antifrost.....	101
[3.5] Operation mode schedule.....	101
[3.6] Additional zone.....	101
[3.7] Max. heating overshoot LWT.....	102
[3.8] Averaging time.....	103
[3.9] Max. cooling undershoot LWT.....	103
[3.10] NOT USED.....	103
[3.11] Undercooling setpoint.....	103
[3.12] Overheating setpoint.....	104
[3.13] Bizone kit.....	104
[3.14] Room thermostat present.....	106
[3.15] Heatpump minimum on time.....	106
[3.16] Operation allowance: Cooling.....	106
[4] Domestic hot water.....	107
[4.1] Single heat-up.....	107
[4.2] NOT USED.....	107
[4.3] Manual setpoint.....	107
[4.4] Powerful operation setpoint.....	108
[4.5] Reheat setpoint.....	108
[4.6] Single heat-up schedule.....	108
[4.7] Heat up mode.....	108
[4.8] NOT USED.....	109
[4.9] NOT USED.....	109
[4.10] Disinfection / [4.18] Disinfection enable.....	109
[4.11] Operation range.....	111
[4.12] Hysteresis.....	112
[4.13] DHW pump.....	112
[4.14] Booster heater.....	113
[4.15] NOT USED.....	113
[4.16] Add. source take over during SH/C.....	113
[4.17] Add. source DHW always on request.....	114
[4.18] Disinfection enable.....	114
[4.19] Reheat trigger threshold.....	114
[4.20] Add. source delay timer.....	115
[4.21] NOT USED.....	115
[4.22] NOT USED.....	115
[4.23] Offset BSH setpoint.....	115
[4.24] Enable reheat schedule.....	116
[4.25] Reheat schedule.....	116
[4.26] DHW pump schedule.....	116
[5] Settings.....	117
[5.1] Forced defrost.....	117
[5.2] Quiet operation.....	118
[5.3] Time/date.....	118
[5.4] Breadcrumbs.....	118
[5.5] Backup heater.....	118
[5.6] Capacity shortage.....	120
[5.7] Overview field settings.....	121
[5.8] NOT USED.....	121
[5.9] Location and language.....	121
[5.10] NOT USED.....	121
[5.11] Reset fan operation hours.....	121
[5.12] Keyboard lay-out.....	122
[5.13] Advanced settings.....	122
[5.14] Bivalent settings/Tank boiler settings.....	122
[5.15] NOT USED.....	126
[5.16] NOT USED.....	126
[5.17] Display brightness.....	126

[5.18] System restart.....	126
[5.19] Diverter valve Type.....	126
[5.20] NOT USED.....	126
[5.21] Intelligent tank management.....	126
[5.22] External ambient sensor offset.....	131
[5.23] Emergency selection.....	132
[5.24] NOT USED.....	133
[5.25] NOT USED.....	133
[5.26] Display inactivity timer.....	133
[5.27] Holiday.....	133
[5.28] Balancing.....	133
[5.29] Refrigerant recovery mode.....	135
[5.30] Emergency acknowledgement.....	135
[5.31] NOT USED.....	136
[5.32] Tank boiler present.....	136
[5.33] NOT USED.....	136
[5.34] NOT USED.....	136
[5.35] Pump limitation service.....	136
[5.36] Water pipe freeze prevention.....	136
[5.37] Bivalent present.....	137
[6] Information.....	138
[6.1] NOT USED.....	138
[6.2] Dealer information.....	138
[6.3] Sensors.....	138
[6.4] Actuators.....	138
[6.5] Operation modes.....	139
[6.6] About.....	141
[6.7] Indoor unit model name/[6.8] Indoor unit serial number.....	141
[7] Maintenance mode.....	142
[8] Connectivity.....	143
[8.1] TCP/IP configuration.....	143
[8.2] Connection status.....	143
[8.3] Wireless gateway.....	143
[8.4] Connection details.....	144
[8.5] Daikin Home Controls.....	144
[8.6] Safe removal USB drive.....	144
[8.7] Modbus TCP/IP (502).....	145
[8.8] Modbus TCP/IP TLS (802).....	145
[8.9] Remove from cloud.....	145
[8.10] Connect to ONECTA cloud.....	145
[8.11] Cloud connection type.....	145
[9] Energy.....	146
[9.1] Electricity price.....	146
[9.2] Electricity price baseline.....	146
[9.3] Electricity price schedule enable.....	146
[9.4] Electricity price schedule.....	147
[9.5] Gas price.....	147
[9.6] NOT USED.....	147
[9.7] NOT USED.....	147
[9.8] NOT USED.....	147
[9.9] Legal disclaimer.....	147
[9.10] NOT USED.....	147
[9.11] Boiler efficiency.....	147
[9.12] PE factor.....	147
[9.13] Energy price considered.....	148
[9.14] Demand response.....	148
[9.15] System limitations.....	154
[10] Configuration wizard.....	156
[11] Malfunctioning.....	157
To display the help text in case of a malfunction.....	157
[12] NOT USED.....	158
[13] Field IO.....	159

# 1 About this document

## Target audience

Authorised installers

## Software version

The settings in this document are applicable for user interface software **v3.x.x** (x = 0, 1, 2, ..., 255). To see the software version of your user interface, go to [6.6.6]: **Information > About > MMI firmware version**.

## Documentation set

This document is part of a documentation set. The complete set consists of:

- **This configuration reference guide:**

- This configuration reference guide is applicable for all models that are operated via the Daikin Altherma 4 MMI (user interface of the unit).
- Format: Digital files on <https://www.daikin.eu>. Use the search function 🔍 to find your model.

- **For other applicable manuals:**

See the installer reference guide of your model.

The latest revision of the supplied documentation is published on the regional Daikin website and is available via your dealer.

The original instructions are written in English. All other languages are translations of the original instructions.

## 2 Possible screens: Overview



### INFORMATION

Some functions are visualised on the user interface, but are not available for your system.

The most common screens are as follows:







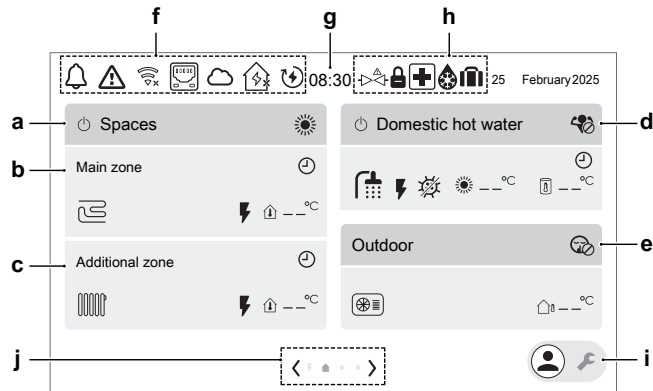











- Home screen
- Energy flow – System overview screen
- Main screen (two screens)
- Setpoint screen





















### 2.1 Home screen







The home screen gives an overview of the unit configuration and the room and setpoint temperatures. Only symbols applicable for your configuration are visible on the home screen.



Item	Description		
<b>a</b>	<b>Spaces</b> Shortcut to setting [3.2].		
	<b>a1</b>	Climate control ON / OFF	
	<b>a2</b>	Operation mode:	
			Heating
			Cooling
	Automatic		
<b>b</b>	<b>Main zone</b> This zone can be renamed in <b>Zone name</b> [1.21])		
	<b>b1</b>	Heat emitter type:	
			Underfloor heating
			Heat pump convector
		Radiator	
<b>b2</b>		Backup heater ON	
<b>b3</b>		Measured temperature ( <b>Main zone</b> )	

Item	Description		
<b>c</b>	<b>Additional zone</b> This zone can be renamed in <b>Zone name</b> [2.21])		
	<b>c1</b>	Heat emitter type:	
		 Underfloor heating	
		 Heat pump convector	
		 Radiator	
<b>c2</b>	 Backup heater ON		
<b>c3</b>	 Measured temperature ( <b>Additional zone</b> )		
<b>d</b>	<b>Domestic hot water</b> Shortcut to setting [4.1].		
	<b>d1</b>	 Domestic hot water ON / OFF	
	<b>d2</b>	Powerful heating mode:	
		 Powerful heating mode ON	
		 Powerful heating mode OFF	
	<b>d3</b>	 Domestic hot water ON	
	<b>d4</b>	 Booster heater (in case of wall-mounted units) or backup heater (in case of floor-standing or ECH <sub>2</sub> O units) ON	
	<b>d5</b>	DHW operation mode:	
		 Disinfection mode active	
		 Manual mode ON	
		 Powerful heating mode ON	
		 Reheat mode active	
		 Schedule and reheat mode active	
		 Scheduled reheat mode active	
	<b>d6</b>	 Target tank temperature	
 Measured tank temperature			



	Item	Description	
e	Outdoor	Shortcut to setting [5.2].	
	e1	 Outdoor unit	
	e2	Quiet operation:	
		 Off	
		 Manual	
	 Scheduled		
	e3	Quiet operation level:	
		 Quiet	
		 More quiet	
	 Most quiet		
e4	 Measured outdoor temperature		
f	Status icons		
	f1	 A warning occurred.	
	f2	 An error occurred.	
	f3	WiFi	
		 WiFi connected	
	 WiFi disconnected		
	f4	 LAN connected	
	f5	Daikin ONECTA	
		 Connected	
	 Not connected		
	f6	Daikin HomeHub	
 Connected			
 Not connected			
 Warning			
f7	 Smart energy enabled		
f8	 DEMO Demo mode active		
f9	 Remote firmware update download is ongoing <b>Note:</b> Downloading can take up to 60 minutes. <b>Note:</b> During downloading, normal operation will continue. Once downloading is finished, the unit gently shuts down its operation to reboot the system and will restart afterwards (if required).		
g	Clock		





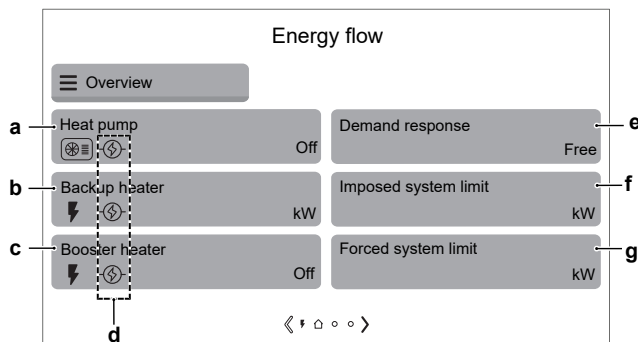







Item	Description	
<b>h</b>	Special functions	
<b>h1</b>		Safety valve closed
<b>h2</b>		Holiday
<b>h3</b>		Defrost/oil return
<b>h4</b>		Emergency
<b>h5</b>		Outdoor unit is in locked state. <b>Note:</b> Unlocking can only be performed by a trained installer.
<b>i</b>	Installer switch. To switch between user and installer mode.	
		User mode
		Installer mode
<b>j</b>	Navigation / pagination	

## 2.2 Energy flow – System overview screen

Starting from the home screen, tap the left arrow to view the system overview screen.



Item	Description	
<b>a</b>	Heat pump	Shows the status of the heat pump (On/Off).
<b>b</b>	Backup heater	Shows the active capacity of the backup heater.  = electrical heater
<b>c</b>	Booster heater	Shows the status of the booster heater (if applicable) (On/Off).  = electrical heater

Item	Description										
<b>d</b> Shows the demand response status (limiting status) of each actuator:	<table border="1"> <tr> <td data-bbox="585 244 908 331">  </td> <td data-bbox="908 244 1506 331">The actuator is actively forced OFF via demand response.</td> </tr> <tr> <td data-bbox="585 331 908 427">  (red)         </td> <td data-bbox="908 331 1506 427">The limit is active but overruled.</td> </tr> <tr> <td data-bbox="585 427 908 544">  (blue)         </td> <td data-bbox="908 427 1506 544">The limit is active and the actuator is actively limited (this can also mean that the heat source is completely switched OFF by the limit).</td> </tr> <tr> <td data-bbox="585 544 908 640">  (black)         </td> <td data-bbox="908 544 1506 640">The limit is active but not limiting.</td> </tr> <tr> <td data-bbox="585 640 908 689">No symbol</td> <td data-bbox="908 640 1506 689">No limit active.</td> </tr> </table>		The actuator is actively forced OFF via demand response.	 (red)	The limit is active but overruled.	 (blue)	The limit is active and the actuator is actively limited (this can also mean that the heat source is completely switched OFF by the limit).	 (black)	The limit is active but not limiting.	No symbol	No limit active.
	The actuator is actively forced OFF via demand response.										
 (red)	The limit is active but overruled.										
 (blue)	The limit is active and the actuator is actively limited (this can also mean that the heat source is completely switched OFF by the limit).										
 (black)	The limit is active but not limiting.										
No symbol	No limit active.										
<b>e</b> Demand response	<p>Shows the current demand response mode:</p> <p>When [9.14.1] = <b>Smart Grid ready contacts</b>, following modes are possible:</p> <ul style="list-style-type: none"> <li>▪ Free</li> <li>▪ Forced off</li> <li>▪ Forced on</li> <li>▪ Recommended on</li> </ul> <p>When [9.14.1] = <b>Smart Meter Contact</b>, following mode is shown:</p> <ul style="list-style-type: none"> <li>▪ Reduced</li> </ul>										
<b>f</b> Imposed system limit	<p>Imposed system limits are dynamic. They are determined by external connections.</p> <ul style="list-style-type: none"> <li>▪ <b>Greyed out:</b> Not active.</li> <li>▪ <b>Not greyed out:</b> A maximum limit to the power (kW) consumption of the heat pump and the electrical heat sources is active. The limit is shown here. However, this limit can be ignored when the unit runs protective functions:             <ul style="list-style-type: none"> <li>- Defrost</li> <li>- Water pipe freeze prevention</li> <li>- Start-up control</li> <li>- Maintenance mode</li> </ul> </li> </ul>										

Item		Description
g	Forced system limit	<p>Forced system limits are static. They are fixed values set in the user interface by the installer.</p> <ul style="list-style-type: none"> <li>▪ <b>Greyed out:</b> Not active.</li> <li>▪ <b>Not greyed out:</b> A maximum limit to the power (kW) or current (A) consumption of the heat pump and the electrical heat sources is active. The limit is shown here. However, this limit can be ignored when the unit runs protective functions:                             <ul style="list-style-type: none"> <li>- Defrost</li> <li>- Water pipe freeze prevention</li> <li>- Start-up control</li> <li>- Maintenance mode</li> </ul> </li> </ul>

### 2.3 Main menu screen

Starting from the home screen, tap the right arrow to view the first main menu screen. Tap the right arrow a second time to view the second main menu screen. From the main menu screens, you can access the different setpoint screens and submenus.



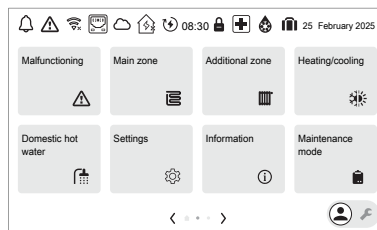



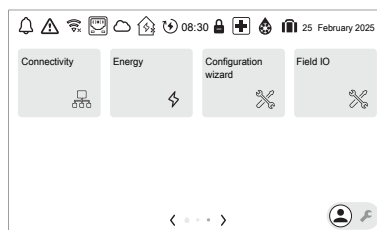



Main menu screen 1:



Main menu screen 2:



Submenu		Description
[11]	Malfunctioning	<p><b>Restriction:</b> Only displayed if a malfunction occurs.</p> <p>See "<a href="#">To display the help text in case of a malfunction</a>" [▶ 157] for more information.</p>
[1]	Main zone	<p>Shows the applicable symbol for your main zone emitter type.</p> <p>Set the leaving water temperature for the main zone.</p>

Submenu		Description
[2]	 Additional zone	Shows the applicable symbol for your additional zone emitter type. Set the leaving water temperature for the main zone.
[3]	 Heating/cooling	Shows the applicable symbol for your unit. Put the unit in heating mode or cooling mode. You cannot change the mode on heating only models.
[4]	 Domestic hot water	<b>Restriction:</b> Only displayed if a domestic hot water tank is present. Set the domestic hot water tank temperature.
[5]	 Settings	Settings for user and installer. Installer settings are only shown in the installer mode (the installer switch is in the  position)
[6]	 Information	Displays data and information about the indoor unit.
[7]	 Maintenance mode	<b>Restriction:</b> Only for the installer. Perform tests and maintenance.
[8]	 Connectivity	<b>Restriction:</b> Only for the installer. Gives access to advanced settings.
[9]	 Energy	Shows the electricity consumption.
[10]	 Configuration wizard	<b>Restriction:</b> Only for the installer. For setting the most important initial settings.
[12]	NOT USED	
[13]	 Field IO	<b>Restriction:</b> Only for the installer. Terminal pin mapping for certain functions.

## 2.4 Setpoint screen

The setpoint screen is displayed for screens describing system components that need a setpoint value.

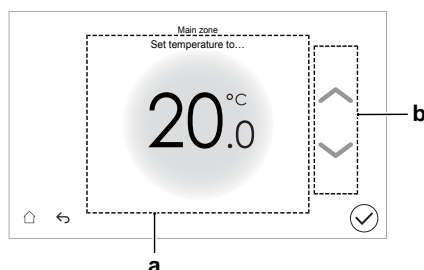

Item	Description
<b>a</b>	Desired temperature.
<b>b</b>	Tap the up/down arrows in this area to increase/decrease the temperature.

# 3 Schedules

## 3.1 Using and programming schedules

### About schedules

Depending on your system layout and installer configuration, schedules for multiple controls may be available.

You can...	See...
Set if a specific control needs to act according to a schedule.	" <b>Activation screen</b> " in " <a href="#">Possible schedules</a> " [▶ 14]
Select which schedule you currently want to use for a specific control. The system contains some predefined schedules. You can:	
Consult which schedule is currently selected.	" <b>Schedule/Control</b> " in " <a href="#">Possible schedules</a> " [▶ 14]
Select another schedule if needed.	" <a href="#">To select which schedule you currently want to use</a> " [▶ 14]
Program your own schedules if the predefined schedules are not satisfactory. The actions you can program are control specific.	<ul style="list-style-type: none"> <li>"<b>Possible actions</b>" in "<a href="#">Possible schedules</a>" [▶ 14]</li> <li>"<a href="#">3.2 Schedule Example</a>" [▶ 20] screen:</li> </ul>

### To select which schedule you currently want to use

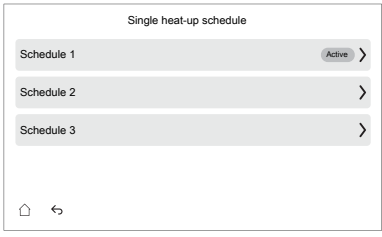
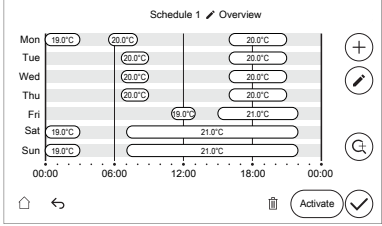
<b>1</b>	<p>Go to the schedule related to the specific control. For an overview, see "<a href="#">Possible schedules</a>" [▶ 14].</p> <p><b>Example:</b></p> <ul style="list-style-type: none"> <li>[1.3] Main zone &gt; Heating schedule.</li> <li>[1.4] Main zone &gt; Cooling schedule</li> </ul>
<b>2</b>	<p>Select the schedule that you currently want to use.</p> 
<b>3</b>	<p>Tap the <b>Activate</b> button.</p> 
<b>4</b>	<p>Confirm with the ✓ button.</p>

### Possible schedules

The table contains the following information:

- **Schedule/Control:** This column shows you where you can consult the currently selected schedule for the specific control. If needed, you can:
  - Select another schedule. See ["To select which schedule you currently want to use"](#) [▶ 14].
  - Program your own schedule. See ["3.2 Schedule screen: Example"](#) [▶ 20].
- **Predefined schedules:** Number of available predefined schedules in the system for the specific control. If needed, you can program your own schedule.
- **Activation screen:** For most controls, a schedule is only effective if it activated in its corresponding activation screen. This entry shows you where to activate it.
- **Possible actions:** Actions you can use when programming a schedule.

Schedule/Control	Description
<p>[1.3] Main zone &gt; Heating schedule</p>	<p><b>Predefined schedules:</b> 3</p> <p><b>Activation:</b> [1.2] Heating schedule enable</p> <p><b>Possible actions:</b> Temperatures within range</p> <p><b>Restriction:</b> Not for external room thermostat control.</p> <p>Schedule for the main zone in heating mode to set the desired leaving water or room temperature (depending on the installed system).</p> <p><b>Note:</b> In case of room temperature scheduling, the baseline temperature will be used at times when no temperature is scheduled (i.e. in between the schedule blocks). To set the baseline temperature, go to [1.34] <b>Main zone &gt; Heating target baseline</b></p> <p><b>Note:</b> In case of LWT scheduling, operation will be OFF when no temperature is scheduled.</p> <p>The influence of the LWT setpoint mode [1.5] is as follows:</p> <ul style="list-style-type: none"> <li>▪ In <b>Fixed</b> LWT setpoint mode, the LWT schedules need to be selected.</li> </ul> <p><b>Note:</b> When <b>Fixed</b> setpoint mode is selected, the shift schedules are available, but will NOT have any effect.</p> <ul style="list-style-type: none"> <li>▪ In <b>Weather dependent</b> LWT setpoint mode, the shift schedules need to be selected.</li> </ul> <p><b>Note:</b> When <b>Weather dependent</b> setpoint mode is selected, the fixed schedules are available but will NOT have any effect.</p>

Schedule/Control	Description
<p>[1.4] <b>Main zone &gt; Cooling schedule</b></p> <p>Schedule for the main zone in cooling mode to set the desired leaving water or room temperature (depending on the installed system).</p>	<p><b>Predefined schedules:</b> 1</p> <p><b>Activation:</b> [1.23] <b>Cooling schedule enable</b></p> <p><b>Possible actions:</b> Temperatures within range</p> <p><b>Restriction:</b> Not for external room thermostat control.</p> <p><b>Note:</b> In case of room temperature scheduling, the baseline temperature will be used at times when no temperature is scheduled (i.e. in between the schedule blocks). To set the baseline temperature, go to [1.35] <b>Main zone &gt; Cooling target baseline</b></p> <p><b>Note:</b> In case of LWT scheduling, operation will be OFF when no temperature is scheduled.</p> <p>The influence of the LWT setpoint mode [1.5] is as follows:</p> <ul style="list-style-type: none"> <li>▪ In <b>Fixed</b> LWT setpoint mode, the LWT schedules need to be selected. <p><b>Note:</b> When <b>Fixed</b> setpoint mode is selected, the shift schedules are available, but will NOT have any effect.</p> </li> <li>▪ In <b>Weather dependent</b> LWT setpoint mode, the shift schedules need to be selected. <p><b>Note:</b> When <b>Weather dependent</b> setpoint mode is selected, the fixed schedules are available but will NOT have any effect.</p> </li> </ul>
<p>[2.3] <b>Additional zone &gt; Heating schedule</b></p> <p>Schedule for the additional zone in heating mode to set the desired leaving water temperature.</p>	<p><b>Predefined schedules:</b> 3</p> <p><b>Activation:</b> [2.2] <b>Heating schedule enable</b></p> <p><b>Possible actions:</b> Leaving water temperatures within range</p> <p><b>Restriction:</b> Only for LWT control.</p> <p><b>Note:</b> In case of LWT scheduling, operation will be OFF when no temperature is scheduled.</p> <p>The influence of the LWT setpoint mode [2.5] is as follows:</p> <ul style="list-style-type: none"> <li>▪ In <b>Fixed</b> LWT setpoint mode, the LWT schedules need to be selected. <p><b>Note:</b> When <b>Fixed</b> setpoint mode is selected, the shift schedules are available, but will NOT have any effect.</p> </li> <li>▪ In <b>Weather dependent</b> LWT setpoint mode, the shift schedules need to be selected. <p><b>Note:</b> When <b>Weather dependent</b> setpoint mode is selected, the fixed schedules are available but will NOT have any effect.</p> </li> </ul>

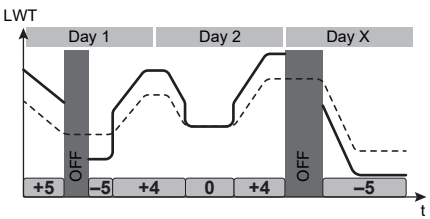
Schedule/Control	Description
<p>[2.4] Additional zone &gt; Cooling schedule</p> <p>Schedule for the additional zone in cooling mode to set the desired leaving water temperature.</p>	<p><b>Predefined schedules:</b> 1</p> <p><b>Activation:</b> [2.27] Cooling schedule enable</p> <p><b>Possible actions:</b> Leaving water temperatures within range</p> <p><b>Restriction:</b> Only for LWT control.</p> <p><b>Note:</b> In case of LWT scheduling, operation will be OFF when no temperature is scheduled.</p> <p>The influence of the LWT setpoint mode [2.5] is as follows:</p> <ul style="list-style-type: none"> <li>In <b>Fixed</b> LWT setpoint mode, the LWT schedules need to be selected.                     <p><b>Note:</b> When <b>Fixed</b> setpoint mode is selected, the shift schedules are available, but will NOT have any effect.</p> </li> <li>In <b>Weather dependent</b> LWT setpoint mode, the shift schedules need to be selected.                     <p><b>Note:</b> When <b>Weather dependent</b> setpoint mode is selected, the fixed schedules are available but will NOT have any effect.</p> </li> </ul>
<p>[1.24] Main zone &gt; Leaving water shift heating schedule</p>	<p><b>Predefined schedules:</b> 3</p> <p><b>Activation:</b> [1.36] Scheduled WD LWT shift for heating</p> <p><b>Possible actions:</b> Leaving water shift temperatures on the weather dependent curve.</p> <p><b>Note:</b> Only in case weather-dependent curve is used (see "<a href="#">4 Weather-dependent curve</a>" [▶ 26]) and only for LWT control.</p> <p><b>Remark:</b> In case of LWT shift scheduling, there will be <b>NO operation</b> at times when no temperature shift is scheduled.</p> <p><b>Example:</b></p>  <p>—: Shifted leaving water temperature target          ----: Weather-dependent curve          +5: Temperature shift value</p>

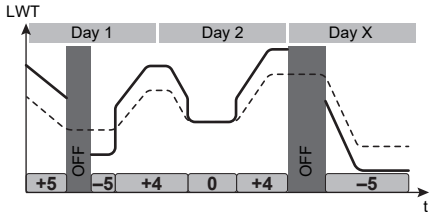
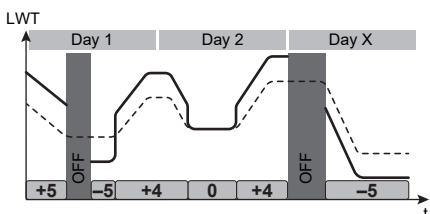
Schedule/Control	Description
<p>[1.25] Main zone &gt; Leaving water shift cooling schedule</p>	<p><b>Predefined schedules:</b> 1</p> <p><b>Activation:</b> [1.37] Scheduled WD LWT shift for cooling</p> <p><b>Possible actions:</b> Leaving water shift temperatures on the weather dependent curve.</p> <p><b>Note:</b> Only in case weather-dependent curve is used (see "<a href="#">4 Weather-dependent curve</a>" [▶ 26]) and only for LWT control.</p> <p><b>Remark:</b> In case of LWT shift scheduling, there will be <b>NO operation</b> at times when no temperature shift is scheduled.</p> <p><b>Example:</b></p>  <p>—: Shifted leaving water temperature target            ----: Weather-dependent curve            [+5]: Temperature shift value</p>
<p>[2.18] Additional zone &gt; Leaving water shift heating schedule</p>	<p><b>Predefined schedules:</b> 3</p> <p><b>Activation:</b> [2.31] Scheduled WD LWT shift for heating</p> <p><b>Possible actions:</b> Leaving water shift temperatures on the weather-dependent curve.</p> <p><b>Note:</b> Only in case weather-dependent curve is used (see "<a href="#">4 Weather-dependent curve</a>" [▶ 26]) and only for LWT control.</p> <p><b>Remark:</b> In case of LWT shift scheduling, there will be <b>NO operation</b> at times when no temperature shift is scheduled.</p> <p><b>Example:</b></p>  <p>—: Shifted leaving water temperature target            ----: Weather-dependent curve            [+5]: Temperature shift value</p>

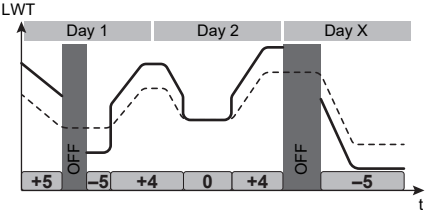
Schedule/Control	Description
<p>[2.19] Additional zone &gt; Leaving water shift cooling schedule</p>	<p><b>Predefined schedules:</b> 1</p> <p><b>Activation:</b> [2.32] Scheduled WD LWT shift for cooling</p> <p><b>Possible actions:</b> Leaving water shift temperatures on the weather-dependent curve.</p> <p><b>Note:</b> Only in case weather-dependent curve is used (see "<a href="#">4 Weather-dependent curve</a>" [▶ 26]) and only for LWT control.</p> <p><b>Remark:</b> In case of LWT shift scheduling, there will be <b>NO operation</b> at times when no temperature shift is scheduled.</p> <p><b>Example:</b></p>  <p>—: Shifted leaving water temperature target  -----: Weather-dependent curve  +5: Temperature shift value</p>
<p>[3.5] Heating/cooling &gt; Operation mode schedule</p> <p>Schedule (per month) for when to operate the unit in heating mode and when in cooling mode.</p>	<p>See "<a href="#">To set the space operation mode</a>" [▶ 100].</p>
<p>[4.6] Domestic hot water &gt; Single heat-up schedule</p> <p>Schedule for the domestic hot water tank temperature for your normal domestic hot water needs.</p> <p><b>Restriction:</b> Only applicable for floor-standing or wall-mounted units.</p>	<p><b>Predefined schedules:</b> 1</p> <p><b>Activation:</b> Not applicable. This schedule is automatically activated if [4.7] <b>Heat up mode</b> is one of the two following settings:</p> <ul style="list-style-type: none"> <li>▪ Schedule only</li> <li>▪ Schedule and reheat</li> </ul> <p><b>Note:</b> In <b>Schedule and reheat</b> mode, the tank also heats up according to the [4.5] <b>Reheat setpoint</b>.</p>
<p>[4.25] Domestic hot water &gt; Reheat schedule</p> <p>This allows for the DHW reheat setpoint to change according to a schedule, instead of using the fixed setpoint [4.5] <b>Reheat setpoint</b></p> <p><b>Restriction:</b> Only applicable for ECH<sub>2</sub>O units.</p>	<p><b>Activation:</b> [4.24] Enable reheat schedule</p>

Schedule/Control	Description
<p>[4.26] Domestic hot water &gt; DHW pump schedule</p> <p>Schedule for the DHW pump for instant hot water (if installed).</p>	<p>Program a schedule for the DHW pump.</p> <p>Program a domestic hot water pump schedule to determine when to turn on and off the pump.</p> <p>When turned on, the pump runs and makes sure hot water is instantly available at the tap. To save energy, only turn on the pump during periods of the day when instant hot water is necessary.</p>
<p>[5.2.2] Settings &gt; Quiet operation &gt; Schedule</p> <p>OR from the home screen: tap on the <b>Outdoor</b> bar, and tap on <b>Schedule</b>.</p> <p>Schedule for when the unit has to use which quiet mode level.</p>	<p><b>Predefined schedules:</b> 1</p> <p><b>Activation:</b> To activate, choose the option <b>Scheduled</b> and confirm.</p> <p>See "<a href="#">To program a quiet mode schedule</a>" [▶ 59].</p>
<p>[9.4] User settings &gt; Electricity price schedule</p> <p>Schedule for when a certain electricity tariff is valid.</p>	<p><b>Predefined schedules:</b> 1</p> <p><b>Activation:</b> [9.3] Electricity price schedule enable</p> <p><b>Possible actions:</b> You can enter the price per kWh.</p> <p>See "<a href="#">5 Energy prices</a>" [▶ 29].</p>

## 3.2 Schedule screen: Example

This example shows how to set a room temperature schedule in heating mode for the main zone.



### INFORMATION

The procedures to program other schedules are similar.

### To program the schedule: overview

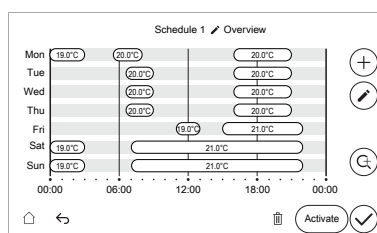

**Prerequisite:** Room temperature scheduling is only possible if room thermostat control is active. If LWT control is active, the schedule applies to the LWT instead.

**Prerequisite:** Scheduling is not possible when using an external room thermostat.

- 1 Go to the schedule.
- 2 (optional) Clear the content of the whole week schedule or the content of a selected day schedule.
- 3 Program the schedule for the weekdays.
- 4 Program the schedule for the weekend.

- 5 Give the schedule a name.



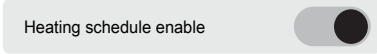

**Note:** You can set one time block for multiple days by selecting any day, workweek, weekend or every day.

**Note:** You can use the zoom in button to get a detailed view of a certain time block.

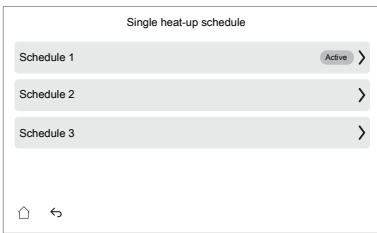

### To go to the schedule

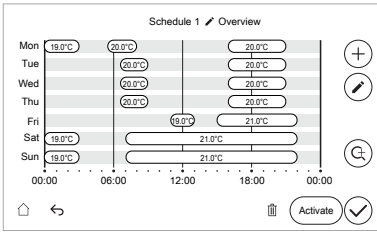

<b>1</b>	Go to [1.2] Main zone > Heating schedule enable.
<b>2</b>	Switch scheduling ON: 
<b>3</b>	Go to [1.3] Main zone > Heating schedule.

### To clear the content of the week schedule

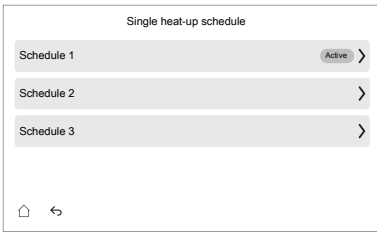

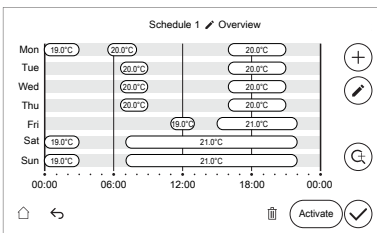
<b>1</b>	Go to the schedule you want to clear: 
<b>2</b>	Tap the  button to delete the schedule: 
<b>3</b>	Confirm with the  button.

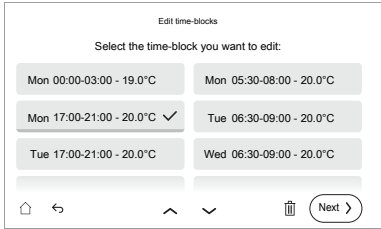
### To clear the content of a time block in a schedule

<b>1</b>	Go to the schedule you want to edit. 
<b>2</b>	Tap the  button to edit the time blocks of the schedule: 

<b>3</b>	<p>Select the time block you want to clear:</p> 
<b>4</b>	Tap the  button to clear the time block.
<b>5</b>	Confirm with the  button.

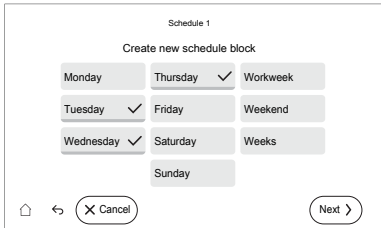
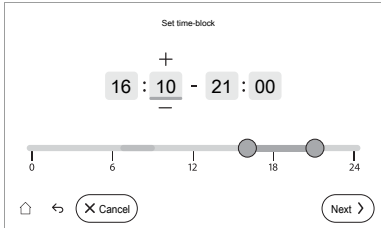
**To add time blocks**

<b>1</b>	Tap the  button to add a time block.
<b>2</b>	<p>Select one or more days for the time block to apply to:</p> 
<b>3</b>	Tap the <b>Next</b> button.
<b>4</b>	<p>Set the first schedule starting and ending time for the time block:</p>  <ul style="list-style-type: none"> <li>▪ Change the time entries by tapping the +/- signs.</li> <li>▪ OR use the bar, by dragging the starting time point and ending time point.</li> </ul>
<b>5</b>	Tap the <b>Next</b> button.
<b>6</b>	Set the desired temperature.
<b>7</b>	Confirm with the  button.
<b>8</b>	<p>Add more time blocks if needed.</p> <p><b>Note:</b> In case of room temperature scheduling, the baseline temperature will be used at times when no temperature is scheduled. To set the baseline temperature, go to:</p> <ul style="list-style-type: none"> <li>▪ [1.34] Main zone &gt; Heating target baseline</li> <li>▪ [1.35] Main zone &gt; Cooling target baseline</li> </ul> <p><b>Remark:</b> In case of LWT scheduling and LWT shift scheduling, there will be <b>NO operation</b> at times when no temperature is scheduled.</p>

**To edit a time block**

<b>1</b>	Tap the  button to edit a time block.
----------	--

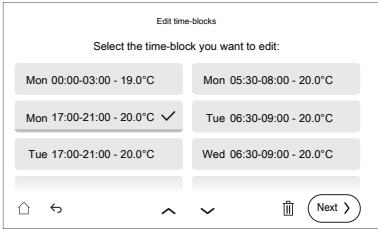
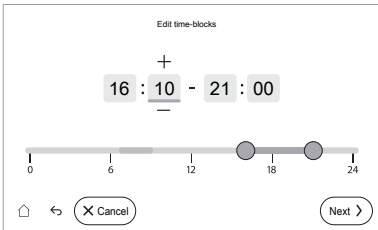
2	<p>Select the time block you want to edit:</p> 
3	<p>Tap the <b>Next</b> button.</p>
4	<p>Set the first schedule starting and ending time for the time block:</p>  <ul style="list-style-type: none"> <li>▪ Change the time entries by tapping the +/- signs.</li> <li>▪ OR use the bar, by dragging the starting time point and ending time point.</li> </ul>
5	<p>Tap the <b>Next</b> button.</p>
6	<p>Set the desired temperature.</p>
7	<p>Confirm with the ✓ button.</p>

### To rename a schedule

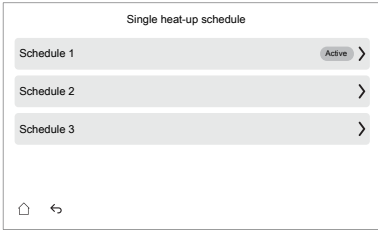
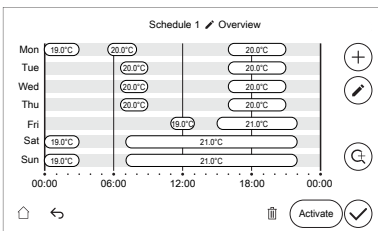
1	<p>Go to the schedule you want to rename:</p> 
2	<p>Tap the ✎ icon next to the schedule name to rename the schedule:</p> 
3	<p>Rename the schedule using the on-screen keyboard. <b>Note:</b> A custom name is limited to basic ASCII characters (A~Z 0~9).</p>
4	<p>Confirm with the ✓ button.</p>

To zoom in on a schedule

**1** Go to the schedule for which you want to see detailed time blocks:

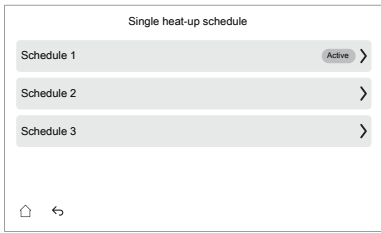

**2** Tap the  button to zoom in on the schedule.

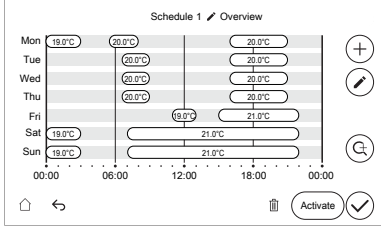

**3** Tap the left/right arrow, to navigate through the full schedule when zoomed in.

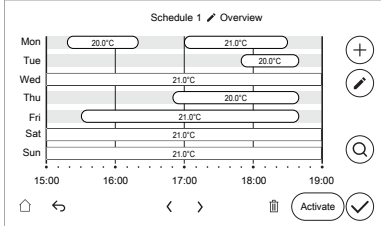

**Note:** 1 tap = 3 hours scroll  
**Note:** When at the beginning or the end of the overview, respectively the left or right arrow is greyed out.

**3** To return to the full schedule overview, tap the  button.

To activate a schedule

**1** Select the schedule:

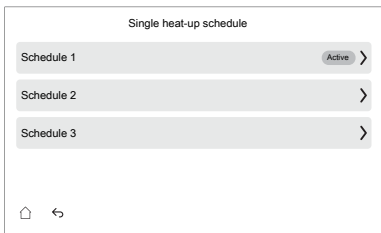

**2** Tap the **Activate** button:

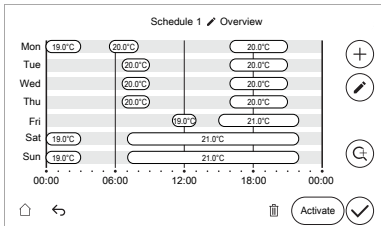

**Note:** In the schedule overview, the active schedule will be marked with 'Active'.

<b>3</b>	Confirm with the ✓ button.
----------	----------------------------

**Usage example: You work in a 3-shift system**

If you work in a 3-shift system, you can do the following:

- 1** Program 3 room temperature schedules and give them appropriate names.  
**Example:** EarlyShift, DayShift and LateShift
- 2** Select the schedule that you currently want to use.

## 4 Weather-dependent curve

### 4.1 What is a weather-dependent curve?

#### Weather-dependent operation

The unit operates 'weather-dependent' if the desired leaving water temperature is determined automatically by the outdoor temperature. It therefore is connected to a temperature sensor on the north wall of the building. If the outdoor temperature drops or rises, the unit compensates instantly. Thus, the unit does not have to wait for feedback by the thermostat to increase or decrease the temperature of the leaving water. Because it reacts more quickly, it prevents high rises and drops of the indoor temperature and water temperature at tap points.

#### Advantage

Weather-dependent operation reduces energy consumption.

#### Weather-dependent curve

To be able to compensate for differences in temperature, the unit relies on its weather-dependent curve. This curve defines how much the temperature of the leaving water must be at different outdoor temperatures. Because the slope of the curve depends on local circumstances such as climate and the insulation of the building, the curve can be adjusted by an installer or user.

#### Type of weather-dependent curve

The type of weather-dependent curve is "2-points curve".

#### Availability

The weather-dependent curve is available for:

- Main zone - Heating
- Main zone - Cooling
- Additional zone - Heating
- Additional zone - Cooling

### 4.2 Using weather-dependent curves

#### Related screens

The following table describes:

- Where you can define the different weather-dependent curves
- When the curve is used (restriction)

To define the curve, go to...	Curve is used when...
[1.8] Main zone > Heating WD curve	[1.5] Heating setpoint mode = Weather dependent
[1.9] Main zone > Cooling WD curve	[1.7] Cooling setpoint mode = Weather dependent
[2.8] Additional zone > Heating WD curve	[2.5] Heating setpoint mode = Weather dependent
[2.9] Additional zone > Cooling WD curve	[2.7] Cooling setpoint mode = Weather dependent



### INFORMATION

#### Maximum and minimum setpoints



You cannot configure the curve with temperatures that are higher or lower than the set maximum and minimum setpoints for that zone. When the maximum or minimum setpoint is reached, the curve flattens out.

### To define a weather-dependent curve

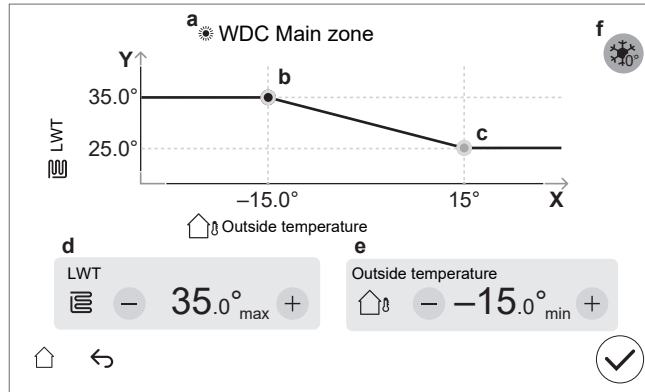
Define the weather-dependent curve using two setpoints (**b, c**). **Example:**



Item	Description
<b>a</b>	Selected weather-dependent curve: <ul style="list-style-type: none"> <li>▪ [1.8] Main zone – Heating (☀)</li> <li>▪ [1.9] Main zone – Cooling (❄)</li> <li>▪ [2.8] Additional zone – Heating (☀)</li> <li>▪ [2.9] Additional zone – Cooling (❄)</li> </ul>
<b>b, c</b>	Setpoint 1 and setpoint 2. You can change them: <ul style="list-style-type: none"> <li>▪ By dragging the setpoint.</li> <li>▪ By tapping the setpoint, and then using the – / + buttons in <b>d, e</b>.</li> </ul>
<b>d, e</b>	Values of the selected setpoint. You can change the values using the – / + buttons.

Item	Description
<p><b>f</b></p>	<p><b>Restriction:</b> Only shown if an increase was already selected via [1.26] for main zone, or [2.20] for additional zone.</p> <p><b>Increase around 0°C</b> (same as setting [1.26] for main zone, and [2.20] for additional zone).</p> <p>Use this setting to compensate for possible heat losses of the building due to the evaporation of melted ice or snow. (e.g. in cold region countries). In heating operation, the desired leaving water temperature is locally increased around an outdoor temperature of 0°C.</p> <div style="text-align: center;"> </div> <p><b>L:</b> Increase; <b>R:</b> Span; <b>X:</b> Outdoor temperature; <b>Y:</b> Leaving water temperature</p> <p>Possible values:</p> <ul style="list-style-type: none"> <li>▪ No</li> <li>▪ increase 2°C, span 4°C</li> <li>▪ increase 2°C, span 8°C</li> <li>▪ increase 4°C, span 4°C</li> <li>▪ increase 4°C, span 8°C</li> </ul>
<p><b>X-axis</b></p>	<p>Outdoor temperature.</p>
<p><b>Y-axis</b></p>	<p>Leaving water temperature for the selected zone.</p> <p>The icon corresponds to the heat emitter for that zone:</p> <ul style="list-style-type: none"> <li>▪ : Underfloor heating</li> <li>▪ : Heat pump convector</li> <li>▪ : Radiator</li> </ul>

**To fine-tune a weather-dependent curve**

The following table describes how to fine-tune the weather-dependent curve of a zone:

You feel...		Fine-tune with setpoints:			
At regular outdoor temperatures ...	At cold outdoor temperatures ...	Setpoint 1 (b)		Setpoint 2 (c)	
		X	Y	X	Y
OK	Cold	↑	↑	—	—
OK	Hot	↓	↓	—	—
Cold	OK	—	—	↑	↑
Cold	Cold	↑	↑	↑	↑
Cold	Hot	↓	↓	↑	↑
Hot	OK	—	—	↓	↓
Hot	Cold	↑	↑	↓	↓
Hot	Hot	↓	↓	↓	↓

## 5 Energy prices

In the system, you can set the following energy prices:

- a fixed gas price (only shown in case bivalent or tank boiler is present)
- three electricity price levels
- a weekly schedule timer for electricity prices.

**Example: How to set the energy prices on the user interface?**

Price	Value in breadcrumb
Gas: 5.3 euro cents/kWh	[9.5]=5.3
Electricity: 12 euro cents/kWh	[9.1]=12

### 5.1 Energy price considered

#### About the setting

**Restriction:** The [9.13] **Energy price considered** setting is only shown in case bivalent or tank boiler is present.

If an external heat source is available, the main heat source will be chosen based on a comparison between both efficiencies of the heat sources.

The decision on which source to select depends on the setting [9.13] **Energy price considered**. This setting defines if the energy prices are considered or not.

- **When considered**, the main heat source will be decided based on the bivalent changeover condition decided by the energy prices with dedicated ambient boundaries selected by the installer.
- **When NOT considered**, the main heat source will be decided based on the ambient boundaries selected by the installer without taking into account the energy prices. This case is mainly capacity driven, where below the selected boundaries, the boiler will cover the space heating.

For more information, see "[\[9.13\] Energy price considered](#)" [▶ 148] and "[\[5.14\] Bivalent settings/Tank boiler settings](#)" [▶ 122].

#### To go to [9.13] Energy price considered

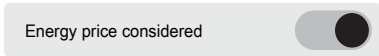
1	Go to [9.13] <b>Energy &gt; Energy price considered</b> .
2	Switch the setting ON or OFF: 

### 5.2 To set the fixed electricity price (no scheduling)

1	Go to [9.1] <b>Energy &gt; Electricity price</b>
2	Select the correct electricity price.
3	Confirm with the ✓ button.

**Note:** When no schedule is set for the electricity price, this price will be taken into account.

**INFORMATION**

Price value ranging from 0.00~5000 valuta/kWh (with 2 significant values).

### 5.3 To set the scheduled electricity baseline price

**Restriction:** Only shown when bivalent or tank boiler is present.When [9.4] **Electricity price schedule** is ON, the electric price follows a block based schedule. The **Electricity price baseline** will be used at times when no electricity price is scheduled (i.e. in between the schedule blocks).

<b>1</b>	Go to [9.2] <b>Energy &gt; Electricity price baseline</b>
<b>2</b>	Select the correct electricity price baseline.
<b>3</b>	Confirm with the ✓ button.

**INFORMATION**

Price value ranging from 0.00~5000 valuta/kWh (with 2 significant values).

### 5.4 To set the electricity price schedule

<b>1</b>	Go to [9.4] <b>Energy &gt; Electricity price schedule</b> .
<b>2</b>	Program the selection using the scheduling screen. See " <a href="#">3.2 Schedule screen: Example</a> " [▶ 20].
<b>3</b>	Confirm with the ✓ button.

To enable the schedule:

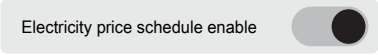
<b>1</b>	Go to [9.3] <b>Energy &gt; Electricity price schedule enable</b> .
<b>2</b>	Switch <b>Electricity price schedule enable</b> ON: 

### 5.5 To set the gas price

**Restriction:** Only when bivalent or tank boiler is present.

<b>1</b>	Go to [9.5] <b>Energy &gt; Gas price</b> .
<b>2</b>	Select the correct gas price.
<b>3</b>	Confirm with the ✓ button.

**INFORMATION**

Price value ranging from 0.00~5000 valuta/kWh (with 2 significant values).

## 5.6 About energy prices in case of an incentive per kWh renewable energy

An incentive can be taken into account when setting the energy prices. Although the running cost can increase, the total operation cost, taking into account the reimbursement will be optimized.



### NOTICE

Make sure to modify the setting of the energy prices at the end of the incentive period.

### 5.6.1 To set the gas price in case of an incentive per kWh renewable energy

Calculate the value for the gas price with the following formula:

- Actual gas price+(Incentive/kWh×0.9)

For the procedure to set the gas price, see ["5.5 To set the gas price"](#) [▶ 30].

### 5.6.2 To set the electricity price in case of an incentive per kWh renewable energy

Calculate the value for the electricity price with following formula:

- Actual electricity price+Incentive/kWh

For the procedure to set the electricity price, see:

- ["5.2 To set the fixed electricity price \(no scheduling\)"](#) [▶ 29]
- ["5.3 To set the scheduled electricity baseline price"](#) [▶ 30]
- ["5.4 To set the electricity price schedule"](#) [▶ 30]

### 5.6.3 Example

This is an example and the prices and/or values used in this example are NOT accurate.

Data	Price/kWh
Gas price	4.08
Electricity price	12.49
Renewable heat incentive per kWh	5

#### Calculation of the gas price

Gas price=Actual gas price+(Incentive/kWh×0.9)

Gas price=4.08+(5×0.9)

Gas price=8.58

#### Calculation of the electricity price

Electricity price=Actual electricity price+Incentive/kWh

Electricity price=12.49+5

Electricity price=17.49

Price	Value in breadcrumb
Gas: 4.08 /kWh	[9.5]=8.6
Electricity: 12.49 /kWh	[9.1]=17

## 6 Domestic hot water control

### 6.1 To determine the domestic hot water control

#### In case of floor-standing or wall-mounted units

Go to [4.7]: Domestic hot water > Heat up mode, and choose:

[4.7]	Domestic hot water control
Reheat	"6.2 Reheat mode with fixed setpoint" [▶ 32]
Schedule and reheat	"6.3 Schedule and reheat mode" [▶ 34]
Scheduled	"6.4 Scheduled mode" [▶ 35]

#### In case of ECH<sub>2</sub>O units

Enable reheat schedule

Go to [4.24]: Domestic hot water > Enable reheat schedule, and choose:

[4.24]	Domestic hot water control
OFF	"6.2 Reheat mode with fixed setpoint" [▶ 32]
ON	"6.5 Reheat mode with scheduled setpoints" [▶ 36]

### 6.2 Reheat mode with fixed setpoint

In **Reheat** mode with fixed setpoint, the DHW tank continuously heats up to a fixed setpoint (i.e. [4.5] **Reheat setpoint**) when the temperature drops below certain values, i.e.:

- Below "[4.5] **Reheat setpoint** – [4.12] **Hysteresis**" for slow temperature decrease.
- Below [4.19] **Reheat trigger threshold** for rapid temperature decrease.

#### Example:

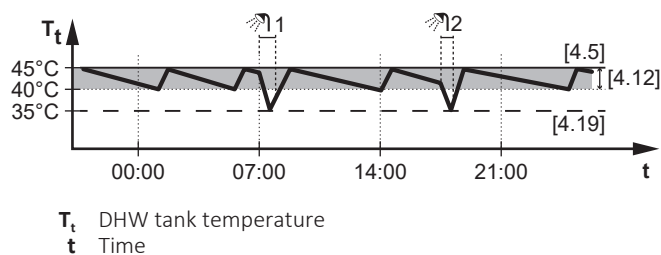

Related settings:

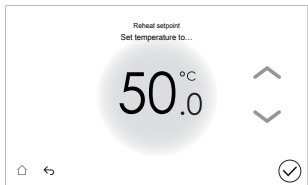
Setting	Description
[4.5] Reheat setpoint	Here you can define the fixed reheat setpoint. 

Setting	Description
[4.12] Hysteresis	<p>Trigger for <b>slow temperature decrease</b>. This trigger compensates for <b>natural heat losses</b> and intermittent DHW usage.</p> <p>The system continuously monitors for heat loss, and when the tank temperature drops below "[4.5] Reheat setpoint – [4.12] Hysteresis", it starts determining when reheating is necessary.</p> <p>This trigger ensures that the system maintains sufficient hot water availability before temperatures fall too low for user demand.</p>
[4.19] Reheat trigger threshold	<p>Trigger for <b>rapid temperature decrease</b>. This trigger compensates for <b>DHW consumption</b>.</p> <p>The tank heats up when the temperature drops below a predefined value. The threshold is set with sufficient spare capacity to prevent an immediate shortage of hot water for the end user.</p> <p>It ensures that the system maintains a reliable supply while avoiding unnecessary reheating cycles.</p> <p><b>Note:</b> Only available in <b>Advanced settings</b> mode.</p> <p><b>Note:</b> Always make sure to use a value lower than [4.5] Reheat setpoint.</p>



#### INFORMATION

In case of wall-mounted units with standalone tank without internal booster heater: There is a risk of space heating capacity shortage in case of frequent domestic hot water operation. Frequent and long space heating/cooling interruption will happen when selecting **Operation mode = Reheat** (only reheat operation allowed for the tank).

### 6.3 Schedule and reheat mode

Schedule and reheat mode is a combination of the following:

- Scheduled mode (i.e. [4.6] Single heat-up schedule), and
- Reheat mode with fixed setpoint (i.e. [4.5] Reheat setpoint, [4.12] Hysteresis and [4.19] Reheat trigger threshold)

**Example:**

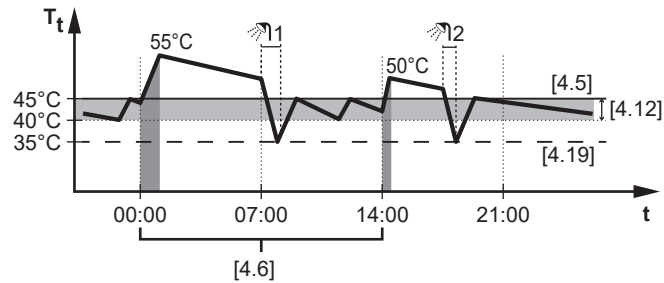

$T_t$  Domestic hot water tank temperature  
 $t$  Time

Related settings:

Setting	Description
[4.6] Single heat-up schedule	See " <a href="#">6.4 Scheduled mode</a> " [▶ 35].
[4.5] Reheat setpoint	See " <a href="#">6.2 Reheat mode with fixed setpoint</a> " [▶ 32].
[4.12] Hysteresis	
[4.19] Reheat trigger threshold	

## 6.4 Scheduled mode

In **Scheduled** mode, the DHW tank heats up to specific temperatures at specific times programmed in [4.6] **Single heat-up schedule**.

**Example:**

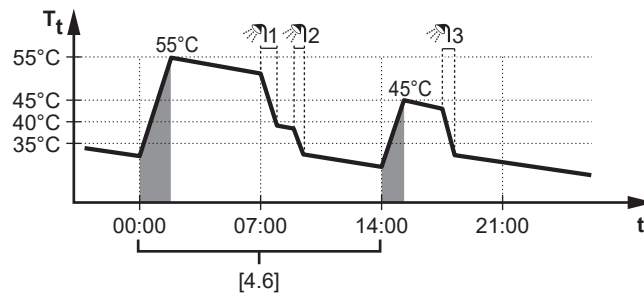

$T_t$  DHW tank temperature  
 $t$  Time

In the example:

- At 00:00 the DHW tank is programmed to heat up the water to **55°C**.
- During the morning, you consume hot water and the DHW tank temperature decreases.
- At 14:00 the DHW tank is programmed to heat up the water to **45°C**. Hot water is available again.
- During the afternoon and evening, you consume hot water again and the DHW tank temperature decreases again.
- At 00:00 the next day, the cycle repeats.

Related settings:

Setting	Description
[4.6] <b>Single heat-up schedule</b>	Here you can program when the DHW tank needs to heat-up to which temperature.  For an example of how to set up a schedule, see " <a href="#">3.2 Schedule screen: Example</a> " [▶ 20].

## 6.5 Reheat mode with scheduled setpoints

In **Reheat** mode with scheduled setpoints, the DHW tank continuously heats up to scheduled setpoints (e.g. RSP1 and RSP2 programmed in [4.25] **Reheat schedule**) when the temperature drops below certain values, i.e.:

- Below "Scheduled setpoint – [4.12] **Hysteresis**" for slow temperature decrease.
- Below [4.19] **Reheat trigger threshold** for rapid temperature decrease.

**Example:**

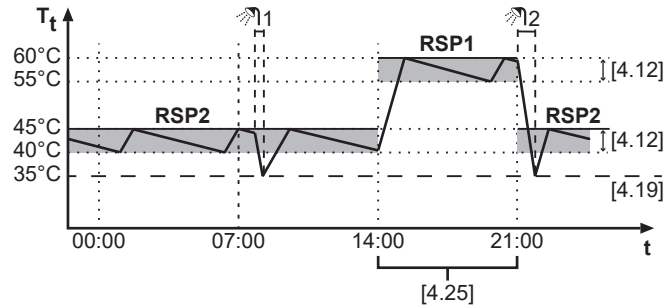

$T_t$  Storage tank temperature  
 $t$  Time

In the example:

- At first, the reheat setpoint is programmed as **45°C** (RSP2).
- Then at 14:00, the value is increased to **60°C** (RSP1).
- And later at 21:00, it is lowered back to **45°C** (RSP2).
- During the night and the morning where no high demand is needed, the temperature is lower.
- With the higher temperature in the afternoon and evening, more hot water is available.
- When the temperature drops below the reheat trigger threshold, the heat pump will heat up to the reheat setpoint programmed at this time block.

Related settings:

Setting	Description
[4.25] <b>Reheat schedule</b>	Here you can define multiple reheat setpoints that suit your daily needs. For an example of how to set up a schedule, see " <a href="#">3.2 Schedule screen: Example</a> " [▶ 20].
[4.12] <b>Hysteresis</b>	See " <a href="#">6.2 Reheat mode with fixed setpoint</a> " [▶ 32].
[4.19] <b>Reheat trigger threshold</b>	

## 6.6 Single heat-up

**Single heat-up** immediately starts heating up the DHW tank using one of the following two modes:

- **Manual**
- **Powerful heating**

### Manual mode

The tank heats up in an efficient way.

### Powerful heating mode

In case of floor-standing or wall-mounted units: The tank heats up using the backup heater or booster heater. For more information, see "[6.6.2 Powerful heating mode](#)" [▶ 37].

In case of ECH<sub>2</sub>O units: The tank heats up using the backup heater or tank boiler. For more information, see "[6.6.2 Powerful heating mode](#)" [▶ 37].

### 6.6.1 Manual mode

#### About Manual mode



**Manual** immediately starts the domestic hot water heat-up, but in a more efficient way than the **Powerful heating**.

Use this mode on days when there is more hot water usage than usual, and more hot water is needed in an efficient way. **Manual** heat-up can take longer than using **Powerful heating**.

#### To check if Manual heat-up is active

If  is displayed on the home screen, DHW tank heat-up is ongoing. However, to see if **Manual** operation is active, you can follow the activate/deactivate steps as described below.

Activate or deactivate **Manual** as follows:

<b>1</b>	Go to [4.1] <b>Domestic hot water</b> > <b>Single heat-up</b> . <b>Note:</b> Tap on the <b>Domestic hot water</b> bar from the home screen to quickly access [4.1].
<b>2</b>	Turn <b>Single heat-up</b> ON using the  button, and select <b>Manual</b> .
<b>3</b>	Confirm with the  button.

Or alternatively:

<b>1</b>	Go to [4.3] <b>Manual setpoint</b> .
<b>2</b>	Press the <b>Start</b> button to activate the heat-up process.

**Note:** To stop an ongoing heat-up process, tap on the **Domestic hot water** bar from the home screen and press the  button.

### 6.6.2 Powerful heating mode

#### About Powerful heating

**Powerful heating** starts the domestic hot water heat-up immediately. To speed up the heat-up, the additional heat source will assist the heat pump when the heat pump has passed its start-up phase, and is operating at maximum capacity.

- In case of floor-standing or wall-mounted units: additional heat source = backup heater or booster heater
- In case of ECH<sub>2</sub>O units: additional heat source = backup heater or tank boiler



Use this mode on days when there is more hot water usage than usual, and more hot water is needed quickly.

The **Powerful heating** mode will consume more energy than the **Manual** mode.

#### To check if Powerful heating is active

If  is displayed on the home screen, **Powerful heating** is active.

Activate or deactivate **Powerful heating** as follows:

<b>1</b>	Go to [4.1] <b>Domestic hot water</b> > <b>Single heat-up</b> . <b>Note:</b> Tap on the <b>Domestic hot water</b> bar from the home screen to quickly access [4.1].
<b>2</b>	Turn <b>Single heat-up</b> ON using the  , and select <b>Powerful heating</b> .
<b>3</b>	Confirm with the  button.

Or alternatively:

<b>1</b>	Go to [4.4] <b>Powerful operation setpoint</b> .
<b>2</b>	Press the <b>Start</b> button to activate the heat-up process.

**Note:** To stop an ongoing heat-up process, tap on the **Domestic hot water** bar from the home screen and press the  button.

#### Usage example: You immediately need more hot water

You are in the following situation:

- You already consumed most of your domestic hot water.
- You cannot wait for the next scheduled action to heat up the domestic hot water tank.

Then you can activate powerful heating. The domestic hot water tank will start heating up the water to the **Powerful operation setpoint** temperature.



#### INFORMATION

When powerful heating is active, the risk of space heating/cooling problems and capacity shortage comfort problems is significant. In case of frequent domestic hot water operation, frequent and long space heating/cooling interruptions will happen.

## 6.7 Additional heat source for DHW

### Additional heat source take-over during space heating/cooling

When this setting is enabled, the additional heat source will be used for tank heat-up if the unit is balancing between space heating/cooling and tank heat-up.

**Restriction:** Only applicable for:

- Wall-mounted units with a single thermistor tank  
Additional heat source = booster heater
- ECH<sub>2</sub>O units + [5.32] **Tank boiler present** = ON.  
Additional heat source = tank boiler

<b>1</b>	Go to [4.16] Domestic hot water > Add. source take over during SH/C
<b>2</b>	Switch Add. source take over during SH/C ON:  <div style="border: 1px solid #ccc; padding: 5px; display: inline-block;"> Add. source take over during SH/C <input type="checkbox"/> </div>

**Note:** Default setting is OFF.

**Note:** When ON, energy consumption can be higher.

#### Additional heat source DHW always on request

When this setting is enabled, the additional heat source will be used together with the heat pump during a tank heat-up, even when the unit is not balancing between space heating/cooling and tank heat-up.

**Restriction:** Only applicable for:

- Wall-mounted units with a single thermistor tank  
Additional heat source = Booster heater
- Floor-standing units  
Additional heat source = Backup heater
- ECH<sub>2</sub>O units + [5.32] Tank boiler present = ON  
Additional heat source = Tank boiler
- ECH<sub>2</sub>O units + [5.32] Tank boiler present = OFF  
Additional heat source = Backup heater

<b>1</b>	Go to [4.17] Domestic hot water > Add. source DHW always on request
<b>2</b>	Switch Add. source DHW always on request ON:  <div style="border: 1px solid #ccc; padding: 5px; display: inline-block;"> Add. source DHW always on request <input type="checkbox"/> </div>

**Note:** Default setting is OFF.

**Note:** When ON, energy consumption will be higher.

## 7 Modbus TCP/IP for Daikin Altherma



### NOTICE

If the unit receives commands from both Modbus and Cloud interfaces, it will execute the command that was received most recently.



### INFORMATION

It may take 15 minutes for the unit to resume operation if you change particular Modbus settings.

### 7.1 Modbus protocol

The following Modbus protocol can be used:

- Modbus TCP/IP

#### Modbus TCP/IP

Parameter	Value
Network	Ethernet
Port	<ul style="list-style-type: none"> <li>▪ No encryption: 502</li> <li>▪ TLS encryption: 802</li> </ul>
IP address	IP address of Daikin Altherma 4

The Modbus algorithm is change based. This means the unit is only updated if a change in configuration is detected. To prevent changes being lost due to communication outages, it is recommended to periodically refresh the state from client side.



### INFORMATION

A total of 3 concurrent connections is possible.

**Example:** 3x using the 502 port, 3x using the 802 port, or a combination of both, e.g. 1x 502 and 2x 802.

### 7.2 Modbus registers

There are 4 types of registers:

- holding registers,
- input registers,
- discrete input registers,
- coil registers.

Register type	Access
Holding register	Read/Write
Input register	Read-only
Discrete input register	Read-only
Coil registers	Read/Write

#### Modbus addressing model

Data model numbering (register offset) is 1-based while PDU addressing is 0-based.

**Example:** To access register 1, you have to use PDU address 0.

The Modbus registers return data in the following formats:

Data type	Signed	Bits	Scaling	Range
Temp16	Signed, two's complement	16	/100	-327.68~327.67°C
Int16			—	-32768~32767
Text16	Unsigned		2 ASCII characters	
Pow16	Signed, two's complement		/100	-327.68~327.67 kW



#### INFORMATION

- Temperature sensor values are returned in Modbus using the Temp16 data format. To convert the value to centigrade, read the Modbus register as a signed 16-bit value and then divide by 100.
- Power values are returned in Modbus using the Pow16 data format. To convert the value to kilowatts (kW), read the Modbus register as a signed 16-bit value and then divide by 100. To write a value in the Modbus register, first multiply your power value in kW with 100.



#### INFORMATION

Unit error codes are returned in Modbus using the Text16 data format. The 16-bit register value MUST be converted to an error code consisting of 2 ASCII characters. Both the high byte value and the low byte value of the 16-bit value represent an ASCII character. Combined, the 2 ASCII characters form the unit error code.

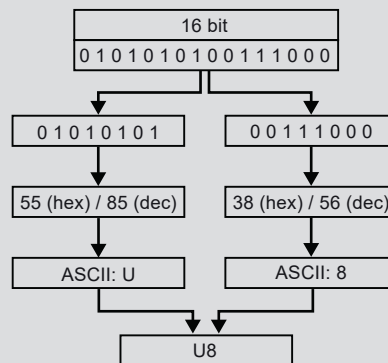

## 7.2.1 Holding registers

Register offset	Name	Type	Range
1	Leaving water Main Heating setpoint	Int16	0~100°C
2	Leaving water Main Cooling setpoint		0~100°C
3 <sup>(a)</sup>	Operation mode		<ul style="list-style-type: none"> <li>▪ 0: Auto</li> <li>▪ 1: Heating</li> <li>▪ 2: Cooling</li> </ul>
4	Space heating/cooling ON/OFF		<ul style="list-style-type: none"> <li>▪ 0: OFF</li> <li>▪ 1: ON</li> </ul>
6	Room thermostat control Heating setpoint Main		12~30°C
7	Room thermostat control Cooling setpoint Main		12~35°C
9	Quiet mode operation		<ul style="list-style-type: none"> <li>▪ 0: OFF</li> <li>▪ 1: ON (Automatic)</li> <li>▪ 2: ON (Manual)</li> </ul>
10	DHW reheat setpoint <sup>(b)</sup>		30~85°C
13	DHW booster mode ON/OFF (Powerful)		<ul style="list-style-type: none"> <li>▪ 0: OFF</li> <li>▪ 1: ON</li> </ul>
14	DHW boost setpoint (Powerful)		Temp16
15	DHW Single heat-up ON/OFF (Manual)	Int16	<ul style="list-style-type: none"> <li>▪ 0: OFF</li> <li>▪ 1: ON</li> </ul>
16	DHW Single heat-up setpoint (Manual)	Temp16	30~85°C
54	Weather-dependent mode Main LWT Heating setpoint offset	Int16	-10~10°C
55	Weather-dependent mode Main LWT Cooling setpoint offset		-10~10°C
56	Smart Grid operation mode		<ul style="list-style-type: none"> <li>▪ 0: Free running</li> <li>▪ 1: Forced off</li> <li>▪ 2: Recommended on</li> <li>▪ 3: Forced on</li> </ul>
58	Imposed power limit	Pow16	0~20 kW

Register offset	Name	Type	Range
63	Leaving water Add Heating setpoint	Int16	3~85°C
64	Leaving water Add Cooling setpoint		3~85°C
66	Weather-dependent mode Add LWT Heating setpoint offset		-10~10°C
67	Weather-dependent mode Add LWT Cooling setpoint offset		-10~10°C
68	Weather-dependent mode Heating Main		<ul style="list-style-type: none"> <li>▪ 0: Fixed</li> <li>▪ 1: Weather dependent</li> </ul>
69	Weather-dependent mode Cooling Main		<ul style="list-style-type: none"> <li>▪ 0: Fixed</li> <li>▪ 1: Weather dependent</li> </ul>
74	Thermostat request Main		<ul style="list-style-type: none"> <li>▪ 0: None</li> <li>▪ 1: Heating</li> <li>▪ 2: Cooling</li> </ul>
75	Thermostat request Add	<ul style="list-style-type: none"> <li>▪ 0: None</li> <li>▪ 1: Heating</li> <li>▪ 2: Cooling</li> </ul>	
76	Room thermostat control Heating setpoint Main	Temp16	12.00~30.00°C
77	Room thermostat control Cooling setpoint Main		12.00~35.00°C
78	Room thermostat control Heating setpoint Add		12.00~30.00°C
79	Room thermostat control Cooling setpoint Add		12.00~35.00°C
80	DHW mode setting	Int16	<ul style="list-style-type: none"> <li>▪ 0: Reheat</li> <li>▪ 1: Schedule and reheat</li> <li>▪ 2: Scheduled</li> </ul>

<sup>(a)</sup> For heating only units, the register will show 32766.

<sup>(b)</sup> The DHW setpoint register is only propagated when the following conditions apply:

- Tank operation is enabled
- Heat pump mode is set to **Reheat only**
- **Setpoint mode** is set to **Fixed**



#### INFORMATION

The available range for setpoint registers is determined by the Minimum and Maximum Setpoint of the function defined in the Daikin Altherma system field settings. See the operation manual of the Daikin Altherma for the setpoint ranges.



#### INFORMATION

If a write to a setpoint register is outside of the configured range of the register, the setpoint will be set to the nearest valid minimum or maximum value. For all other registers, if a value outside of the register range is written, then the register value is NOT updated.

**NOTICE**

**External room thermostat requests.** You can define the external room thermostat requests in different ways:

**1. Via hardware:**

- Install an external room thermostat.
- Go to **External room thermostat** ([1.13] for main zone or [2.13] for additional zone).
- Set **Input source** = **Hardware**.
- In the selection box **Connection type**, select which external room thermostat type you used (**Single contact** or **Dual contact**).

**2. Via Modbus:**

- Go to **External room thermostat** ([1.13] for main zone or [2.13] for additional zone).
- Set **Input source** = **External**.
- Main zone: Use holding register 74: Thermostat request Main.
- Additional zone: Use holding register 75: Thermostat request Add.

**3. Via Cloud:** Momentarily, only available for business-to-business integrators. For more information, see <https://developer.cloud.daikineurope.com>.

- Go to **External room thermostat** ([1.13] for main zone or [2.13] for additional zone).
- Set **Input source** = **External**.
- Use the ONECTA cloud API to adjust the external room thermostat requests.

**NOTICE**

**Smart Grid operation mode.** You can define the Smart Grid operation mode in different ways:

**1. Via hardware:**

- Install 2 incoming Smart Grid contacts.
- Set [9.14.1] = **Smart Grid ready contacts**.
- In the selection box **Connection type**, select **Hardware**.
- Use the 2 incoming Smart Grid contacts to define the mode.

**2. Via Modbus:**

- Set [9.14.1] = **Smart Grid ready contacts**.
- In the selection box **Connection type**, select **External**.
- Use holding register 56: Smart Grid operation mode.

**3. Via Cloud:** Momentarily, only available for business-to-business integrators. For more information, see <https://developer.cloud.daikineurope.com>.

- Set [9.14.1] = **Smart Grid ready contacts**.
- In the selection box **Connection type**, select **External**.
- Use the ONECTA cloud API to adjust the Smart Grid operation mode.

**NOTICE**

**Imposed power limit.** You can define a maximum limit to the power consumption of the heat pump and the electrical heat sources in different ways.

**1. Via hardware contact:**

- Install a Smart Grid meter.
- Set [9.14.1] = **Smart Meter Contact**.
- Define the imposed power limit in [9.14.7] **Smart meter limit**.

**2. Via Modbus:**

- Use holding register 58: Imposed power limit.

**3. Via Cloud:** Momentarily, only available for business-to-business integrators. For more information, see <https://developer.cloud.daikineurope.com>.

- Use the ONECTA cloud API to define the imposed power limit.

**Note:**

- The imposed power limit can be ignored when the unit runs protective functions (defrost, water pipe freeze prevention, start-up control, maintenance mode).
- If the power limit is too strict to allow start-up or defrost operation, the heat pump will not operate.
- If the power limit is not too strict to allow start-up or defrost operation, the heat pump will operate. However, if the limit is exceeded for too long during operation modes other than start-up or defrost, the unit will stop operating.
- If the backup heater needs to support for protective reasons, the backup heater will kick in with at least a capacity of 2 kW (to ensure reliable operation) even if the power limit would be exceeded.

## 7.2.2 Input registers

Register offset	Name	Type	Range
21	Unit abnormality	Int16	<ul style="list-style-type: none"> <li>▪ 0: No error</li> <li>▪ 1: Fault</li> <li>▪ 2: Warning</li> </ul>
22	Unit abnormality code	Text16	2 ASCII characters

Register offset	Name	Type	Range
23	Unit abnormality sub code	Int16	<ul style="list-style-type: none"> <li>▪ If no error: 32766</li> <li>▪ If unit error: 0~99</li> </ul>
30	Circulation pump running		<ul style="list-style-type: none"> <li>▪ 0: OFF</li> <li>▪ 1: ON</li> </ul>
31	Compressor run		<ul style="list-style-type: none"> <li>▪ 0: OFF</li> <li>▪ 1: ON</li> </ul>
32	Booster heater run		<ul style="list-style-type: none"> <li>▪ 0: OFF</li> <li>▪ 1: ON</li> </ul>
33	Disinfection operation		<ul style="list-style-type: none"> <li>▪ 0: OFF</li> <li>▪ 1: ON</li> </ul>
35	Defrost/Restart		<ul style="list-style-type: none"> <li>▪ 0: OFF</li> <li>▪ 1: ON</li> </ul>
36	Hot start		<ul style="list-style-type: none"> <li>▪ 0: OFF</li> <li>▪ 1: ON</li> </ul>
37	3-way valve		<ul style="list-style-type: none"> <li>▪ 0: Space heating</li> <li>▪ 1: DHW</li> </ul>
38	Operation mode		<ul style="list-style-type: none"> <li>▪ 0: None</li> <li>▪ 1: Heating</li> <li>▪ 2: Cooling</li> </ul>
40	Leaving water temperature PHE (plate heat exchanger)		Temp16
41	Leaving water temperature BUH (backup heater)	-100.00~100.00°C	
42	Return water temperature	-100.00~100.00°C	
43	Domestic Hot Water temperature	-100.00~100.00°C	
44	Outside air temperature	-100.00~100.00°C	
45	Liquid refrigerant temperature	-100.00~100.00°C	
49	Flow rate	Int16	0~100 litres/minute
50	Remote controller room temperature (Main)	Temp16	-100.00~100.00°C
51	Heat pump power consumption	Pow16	0~20.00 kW
52	DHW normal operation	Int16	<ul style="list-style-type: none"> <li>▪ 0: Idle/Buffering</li> <li>▪ 1: Operation</li> </ul>
53	Space heating/cooling normal operation		<ul style="list-style-type: none"> <li>▪ 0: Idle/Buffering</li> <li>▪ 1: Operation</li> </ul>

Register offset	Name	Type	Range
54	Leaving water Main Heating setpoint Lower limit	Temp16	15~85°C
55	Leaving water Main Heating setpoint Upper limit		15~85°C
56	Leaving water Main Cooling setpoint Lower limit		5~22°C
57	Leaving water Main Cooling setpoint Upper limit		5~22°C
58	Leaving water Add Heating setpoint Lower limit		15~85°C
59	Leaving water Add Heating setpoint Upper limit		15~85°C
60	Leaving water Add Cooling setpoint Lower limit		5~22°C
61	Leaving water Add Cooling setpoint Upper limit		5~22°C
63	Disinfection state	Int16	<ul style="list-style-type: none"> <li>▪ 0: Unsuccessful</li> <li>▪ 1: Successful</li> <li>▪ 2: Maintain</li> <li>▪ 3: Heat Up</li> </ul>
64	Holiday mode		<ul style="list-style-type: none"> <li>▪ 0: OFF</li> <li>▪ 1: ON</li> </ul>
65	Demand response mode		<ul style="list-style-type: none"> <li>▪ 0: Free</li> <li>▪ 1: Forced Off</li> <li>▪ 2: Forced On</li> <li>▪ 3: Recommended On</li> <li>▪ 4: Reduced</li> </ul>
66	Bypass valve position		0~100%
67	Tank valve position		0~100%
68	Circulation pump speed		0~100 litres/minute
69	Mixed pump PWM in mixing kit		0~100%
70	Direct pump PWM in mixing kit		0~100%
71	Mixing valve position in mixing kit		0~100%

Register offset	Name	Type	Range
72	Mixing Leaving water temperature in mixing kit	Temp16	-100.00~100.00°C
73	Space heating/cooling target for Main zone in mixing kit		-100.00~100.00°C
74	Leaving water temperature pre-PHE outdoor		-128.99~128.99°C
75	Leaving water temperature Tank valve		-127.00~127.00°C
76	Domestic Hot Water Upper temperature		-127.00~127.00°C
77	Domestic Hot Water Lower temperature		-127.00~127.00°C
78	Remote controller room temperature (Add)		-100.00~100.00°C
79	Water pressure		Int16
80	Space heating/cooling target for Main zone	Temp16	-127.00~127.00°C
81	Space heating/cooling target for Add zone		-127.00~127.00°C
82	Abnormality counter (user)	Int16	0~200
83	Unit operation mode		<ul style="list-style-type: none"> <li>▪ 0: Stop</li> <li>▪ 1: Tank Heat Up</li> <li>▪ 2: Space heating</li> <li>▪ 3: Space cooling</li> <li>▪ 4: Actuator</li> </ul>
84	Room Heating setpoint Lower limit	Temp16	12.00~30.00°C
85	Room Heating setpoint Upper limit		12.00~30.00°C
86	Room Cooling setpoint Lower limit		12.00~35.00°C
87	Room Cooling setpoint Upper limit		12.00~35.00°C

## 7.2.3 Discrete input registers

Register offset	Name	Type	Range
1	Shut-off valve	Bit	0~1
2	Backup heater relay 1		0~1
3	Backup heater relay 2		0~1
4	Backup heater relay 3		0~1
5	Backup heater relay 4		0~1
6	Backup heater relay 5		0~1
7	Backup heater relay 6		0~1
8	Booster heater		0~1
9	Tank boiler		0~1
10	Bivalent		0~1
11	Compressor run		0~1
12	Quiet mode active		0~1
13	Holiday active		0~1
14	Antifrost status		0~1
15	Water pipe freeze prevention status		0~1
16	Disinfection operation		0~1
17	Defrost		0~1
18	Hot start		0~1
19	DHW running		0~1
20	Main zone running		0~1
21	Additional zone running		0~1
22	Powerful tank heat up request		0~1
23	Manual tank heat up request		0~1
24	Emergency active		0~1
25	Circulation pump running		0~1
26	Imposed limit acceptance <sup>(a)</sup>		0~1

<sup>(a)</sup> During maintenance mode, the status of this register is false.

## 7.2.4 Coil registers

Register offset	Name	Type	Range
1	Domestic Hot Water ON/OFF	Bit	0~1
2	Main zone ON/OFF		0~1
3	Additional zone ON/OFF		0~1

### 7.3 Modbus TCP/IP for Daikin Altherma

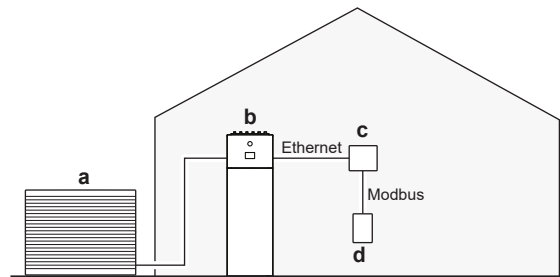

- a** Outdoor unit
- b** Daikin Altherma
- c** Internet router
- d** Home Energy Manager (HEM) or Energy Utility Controller

### 7.4 Third-party Modbus integrations

This use case makes it possible for a third-party Home Energy Manager (HEM) to communicate with the heat pump. Through the home router, they can execute a range of commands, for example changing the setpoint of the heat pump. For the full list of possible commands, see "[7.2 Modbus registers](#)" [▶ 40].

This use case is compatible with the Modbus IP standards.

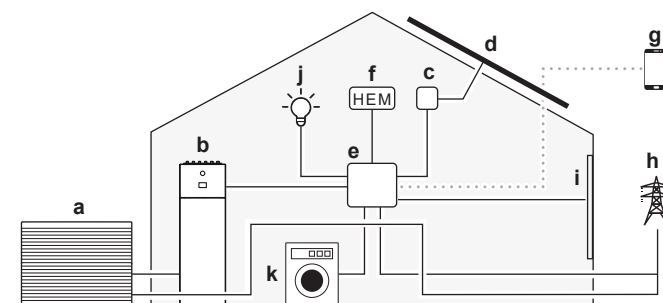

- a** Outdoor unit
- b** Daikin Altherma
- c** Solar inverter
- d** Solar panels
- e** Home router
- f** Home Energy Manager (HEM)
- g** Home automation app
- h** Electrical grid
- i** Smart window blinds
- j** Smart lighting
- k** Smart white goods



#### INFORMATION

Any power limitation is applied to the whole system. This can affect the system performances.

The functionality of the system CAN also be compromised in case of:

- Power loss of the unit,
- Network communication delays.

### 7.5 Smart Grid for utilities

This use case makes it possible for energy utilities to communicate with the heat pump. Through the home router, they can balance the grid and avoid peaks by

enforcing a Smart Grid (SG) operation mode. The SG operation mode adjusts the settings of the heat pump by turning it on/off. In parallel, the power of the heat pump can be adjusted by increasing or decreasing the power limit. For the full list of possible commands, see "7.2 Modbus registers" [▶ 40].

This use case is compatible with the Modbus IP standards.

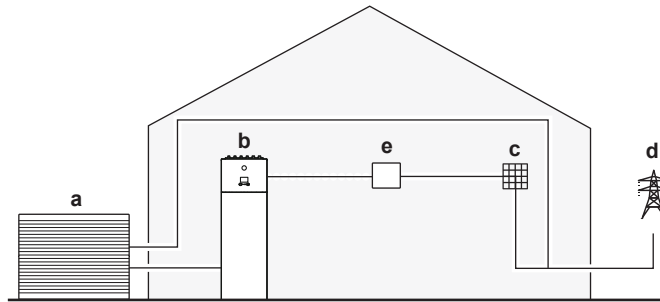

- a Outdoor unit
- b Daikin Altherma
- c Building management or grid controller
- d Electrical grid
- e Home router



#### INFORMATION

Any power limitation is applied to the whole system. This can affect the system performances.

The functionality of the system CAN also be compromised in case of:

- Power loss of the unit,
- Network communication delays.

## 7.6 Energy buffering with Smart Grid

The home router allows a third party (e.g. an energy utility) to set a Smart Grid operation mode. In parallel, the power of the heat pump system can be adjusted by increasing or decreasing the power limit. Both actions help to balance the grid and avoid peaks.

There are 4 possible Smart Grid operation mode requests. Depending on Smart Grid operation mode, energy buffering either happens in the domestic hot water only, or in the domestic hot water tank and in the room.

1	2	SG ready 1.0 operation mode
0	0	Free running
0	1	Forced off
1	0	Recommended on
1	1	Forced on

1	2	SG ready 1.1 operation mode
0	1	Operating state 1 (for a description, see SG ready 1.0: "Forced off" and "Forced on")
1	1	
0	0	Operating state 2 (for a description, see SG ready 1.0: "Free running")
1	0	Operating state 3 (for a description, see SG ready 1.0: "Recommended on")

**Free running (normal operation)**

There is no interference with the normal operation of the unit, except that the power consumption is limited to the Modbus imposed power limit (register 58).

**Forced off (blocked operation)**

The unit is forced to stop (except during protective functions: defrost, water pipe freeze prevention, start-up control, maintenance mode). See also "[\[9.14\] Demand response](#)" [▶ 148]:

- [\[9.14.2\] SH heater take-over during forced off](#)
- [\[9.14.3\] DHW heater take-over during forced off](#)

**Forced on**

If the unit is operating in normal space heating/cooling or DHW mode, it continues in this mode. If the unit is idle, it is activated to store energy (either in the DHW storage tank or the room). The rate at which the unit consumes energy (both during buffering and normal operation) is limited to the Modbus imposed power limit (register 58).

Energy buffering	System requirements	Description
Domestic hot water tank	<ul style="list-style-type: none"> <li>▪ Make sure a domestic hot water tank is part of the system. See "<a href="#">[9.14] Demand response</a>" [▶ 148] for more details about settings.</li> <li>▪ Unit control method (user interface setting [1.12]): no requirements, but mind the information below.</li> </ul>	<p>The system produces domestic hot water. The tank heats up the water up to the maximum tank temperature (depending on the tank type and set by [4.11]).</p> <p>The electrical heaters will assist with the buffering of energy in the domestic hot water tank.</p>
Room (heating)	Unit control method: on the user interface, make sure [1.12] = 2 (room thermostat control)	The system heats up the room up to the comfort setpoint. <sup>(a)</sup>
Room (cooling)	Unit control method: on the user interface, make sure [1.12] = 2 (room thermostat control)	The system cools down the room down to the comfort setpoint. <sup>(b)</sup>

<sup>(a)</sup> In case the actual room temperature is below the comfort heating setpoint.

<sup>(b)</sup> In case the actual room temperature is above the comfort cooling setpoint.

**Recommended on**

If the unit is operating in normal space heating/cooling or DHW mode, it continues in this mode. If the unit is idle, it is activated to store energy. Contrary to **Forced on**, the energy storage during **Recommended on** can be controlled with the allowance flags for room buffering and electrical heaters. The rate at which the unit consumes energy during normal operation is limited to the Modbus imposed power limit (register 58).

Energy buffering	System requirements	Description
Domestic hot water tank	<ul style="list-style-type: none"> <li>Make sure a domestic hot water tank is part of the system. See "[9.14] Demand response" [▶ 148] for more details about settings.</li> <li>Unit control method (user interface setting [1.12]): no requirements, but mind the information below.</li> </ul>	<p>The system produces domestic hot water. The tank heats up the water up to the maximum tank temperature, depending on the tank type and set by [4.11]. If tank buffering is done without electrical heaters, the target temperature is the highest temperature achievable by the heat pump.</p> <p>See also [9.14.6] <b>BUH+BSH support during DHW recommended on.</b></p>
Room (heating)	<ul style="list-style-type: none"> <li>Allow for buffering in the room</li> <li>Unit control method: on the user interface, make sure [1.12] = 2 (room thermostat control)</li> </ul>	<p>The system heats up the room up to the comfort setpoint.<sup>(a)</sup></p> <p>See also: [9.14.4] <b>Allow buffering space H/C</b> [9.14.5] <b>BUH support during SH recommended on</b></p>
Room (cooling)	<ul style="list-style-type: none"> <li>Allow for buffering in the room</li> <li>Unit control method: on the user interface, make sure [1.12] = 2 (room thermostat control)</li> </ul>	<p>The system cools down the room down to the comfort setpoint.<sup>(b)</sup></p> <p>See also [9.14.4] <b>Allow buffering space H/C.</b></p>

<sup>(a)</sup> In case the actual room temperature is below the comfort heating setpoint.

<sup>(b)</sup> In case the actual room temperature is above the comfort cooling setpoint.



#### NOTICE

If the water/tank temperature is too low to allow heat pump operation, and setting [9.14.5] **BUH support during SH recommended on** / [9.14.6] **BUH+BSH support during DHW recommended on** is set to OFF (not allowed), then the electrical heaters will NOT push the heat pump into the operation range (because the electrical heaters are then not allowed).



#### NOTICE

In case of removing the DHW tank from a wall-mounted unit set-up, you MUST follow the configuration wizard.

**INFORMATION**

Room buffering is ONLY possible if the unit control method [1.12] = 2 (room thermostat control). This means that if an external room thermostat (Daikin or third party) is configured for the main zone, room buffering is ONLY possible in the additional zone.

**INFORMATION****Tank/room buffering priority:**

- The system starts tank buffering first. When tank buffering is at its maximum capacity, then the system switches to room buffering (if enabled).
- Tank buffering can switch to room buffering prior to reaching the maximal capacity because of internal unit logic. In normal operation, the maximum running time for domestic hot water is applicable. See the installer reference guide of the indoor unit for more details.
- When room buffering is ongoing and the tank drops below its maximum capacity (e.g. someone takes a shower), then the system stays at room buffering for a certain amount of time before it switches back to tank buffering.

**Buffering in case of leaving water temperature control**

When, on the user interface, [1.12] = 0 (the unit control method is leaving water temperature control), the system is constantly working in normal operation to keep the leaving water at a constant temperature. Energy buffering can only happen in the domestic hot water tank, and only when the system is NOT in normal operation. This is the case in the following two separate cases:

- Space heating/cooling operation is turned OFF

OR

- During space heating operation:
  - Outdoor temperature > space heating setting [3.1]
  - Room frost protection is not active
- During space cooling operation:
  - Outdoor temperature < space cooling setting [3.16]

# 8 Cloud for Daikin Altherma



## NOTICE

If the unit receives commands from both Modbus and Cloud interfaces, it will execute the command that was received most recently.

## 8.1 Third-party Cloud integrations

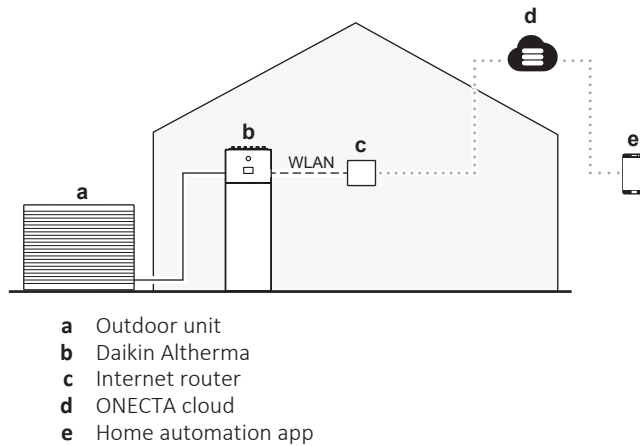

### For individual developers

We offer basic functionality to monitor and control your Daikin Altherma via the ONECTA cloud API. For more information, see <https://developer.cloud.daikineurope.com>.

**Note:** For this feature to work, your Daikin Altherma needs to be connected to the ONECTA cloud by using the ONECTA application.

**Note:** This feature is not meant for regular end users (they can use the ONECTA app instead), but for private or open-source developers:

- Ideal for developers building integrations for personal use or for a group of users.
- Developers or users of the integration must obtain individual API credentials via the self-service feature on the developer portal.
- Daikin does not provide dedicated support to private or open-source developers.

### For enterprises or energy integrators

We offer more functionality. For more information, see <https://developer.cloud.daikineurope.com>.

**Note:** This feature is not meant for regular end users (they can use the ONECTA app instead), but for Business Partners:

- As a Business Partner, you represent a company that focuses on Home Automation, Energy Management, or Demand Response Solutions and creates an integration for your customers.
- API credentials for your integration can be retrieved via the developer portal. Business Partners must have their integration validated and sign a license agreement before distributing it to ONECTA-connected customers. These customers will not need to obtain API credentials individually.

For some of the functionality to work (see notices below: "**3. Via Cloud**"), you will need to do some settings on the user interface before you can adjust the settings via API.



### NOTICE

**External room thermostat requests.** You can define the external room thermostat requests in different ways:

#### 1. Via hardware:

- Install an external room thermostat.
- Go to **External room thermostat** ([1.13] for main zone or [2.13] for additional zone).
- Set **Input source** = **Hardware**.
- In the selection box **Connection type**, select which external room thermostat type you used (**Single contact** or **Dual contact**).

#### 2. Via Modbus:

- Go to **External room thermostat** ([1.13] for main zone or [2.13] for additional zone).
- Set **Input source** = **External**.
- Main zone: Use holding register 74: Thermostat request Main.
- Additional zone: Use holding register 75: Thermostat request Add.

**3. Via Cloud:** Momentarily, only available for business-to-business integrators. For more information, see <https://developer.cloud.daikineurope.com>.

- Go to **External room thermostat** ([1.13] for main zone or [2.13] for additional zone).
- Set **Input source** = **External**.
- Use the ONECTA cloud API to adjust the external room thermostat requests.



### NOTICE

**Smart Grid operation mode.** You can define the Smart Grid operation mode in different ways:

#### 1. Via hardware:

- Install 2 incoming Smart Grid contacts.
- Set [9.14.1] = **Smart Grid ready contacts**.
- In the selection box **Connection type**, select **Hardware**.
- Use the 2 incoming Smart Grid contacts to define the mode.

#### 2. Via Modbus:

- Set [9.14.1] = **Smart Grid ready contacts**.
- In the selection box **Connection type**, select **External**.
- Use holding register 56: Smart Grid operation mode.

**3. Via Cloud:** Momentarily, only available for business-to-business integrators. For more information, see <https://developer.cloud.daikineurope.com>.

- Set [9.14.1] = **Smart Grid ready contacts**.
- In the selection box **Connection type**, select **External**.
- Use the ONECTA cloud API to adjust the Smart Grid operation mode.

**NOTICE**

**Imposed power limit.** You can define a maximum limit to the power consumption of the heat pump and the electrical heat sources in different ways.

**1. Via hardware contact:**

- Install a Smart Grid meter.
- Set [9.14.1] = **Smart Meter Contact**.
- Define the imposed power limit in [9.14.7] **Smart meter limit**.

**2. Via Modbus:**

- Use holding register 58: Imposed power limit.

**3. Via Cloud:** Momentarily, only available for business-to-business integrators. For more information, see <https://developer.cloud.daikineurope.com>.

- Use the ONECTA cloud API to define the imposed power limit.

**Note:**

- The imposed power limit can be ignored when the unit runs protective functions (defrost, water pipe freeze prevention, start-up control, maintenance mode).
- If the power limit is too strict to allow start-up or defrost operation, the heat pump will not operate.
- If the power limit is not too strict to allow start-up or defrost operation, the heat pump will operate. However, if the limit is exceeded for too long during operation modes other than start-up or defrost, the unit will stop operating.
- If the backup heater needs to support for protective reasons, the backup heater will kick in with at least a capacity of 2 kW (to ensure reliable operation) even if the power limit would be exceeded.

# 9 Other functionalities

## 9.1 To set Time/date

<b>1</b>	Go to [5.3] <b>Settings &gt; Time/date</b> .
----------	--

**Note:** If your region observes daylight saving time, you can switch [5.3] **Daylight savings time** ON.

## 9.2 Using quiet mode

### About quiet mode

You can use quiet mode to decrease the sound of the outdoor unit. However, this also decreases the heating/cooling capacity of the system. There are multiple quiet mode levels.

The user can:

- Completely deactivate quiet mode (user)
- Manually activate a quiet mode level (user)
- Program a quiet mode schedule (advanced user)

The installer can:

- Configure restrictions based on local regulations



### INFORMATION

If the outdoor temperature is below zero, we recommend to NOT use the most quiet level as it could lead to slow heat-ups and comfort loss.

### To check if quiet mode is active

If one of the following icons is displayed on the home screen, quiet mode is active:

- Quiet
- More quiet
- Most quiet

### To completely deactivate quiet mode

(required permission level = user)

<b>1</b>	Go to [5.2] <b>Settings &gt; Quiet operation</b> .
----------	--

**Note:** Tap on the **Outdoor** bar from the home screen to quickly access [5.2].

<b>2</b>	Tap <b>Off</b> .
----------	------------------

<b>3</b>	Confirm with the  button.
----------	---------------------------

**Result:** The unit never runs in quiet mode.

### To manually activate a quiet mode level

(required permission level = user)

<b>1</b>	Go to [5.2] <b>Settings &gt; Quiet operation</b> .
----------	--

**Note:** Tap on the **Outdoor** bar from the home screen to quickly access [5.2].

2	Tap <b>Manual</b> .
3	Confirm with the ✓ button.
4	In [5.2.1] <b>Quiet mode - Manual</b> , select the applicable quiet mode level. Possible values: <ul style="list-style-type: none"> <li>▪ Off</li> <li>▪ Quiet</li> <li>▪ More quiet</li> <li>▪ Most quiet</li> </ul>
5	Confirm with the ✓ button. <b>Result:</b> The unit always runs in the selected quiet mode level.

### To program a quiet mode schedule

(required permission level = advanced user)

1	Go to [5.2] <b>Settings &gt; Quiet operation</b> . <b>Note:</b> Tap on the <b>Outdoor</b> bar from the home screen to quickly access [5.2].
2	Tap <b>Scheduled</b> . <b>Result:</b> The following buttons appear: <ul style="list-style-type: none"> <li>▪ <b>Schedule</b></li> <li>▪ <b>Restrictions</b> (only for installers)</li> </ul>
3	Tap <b>Schedule</b> .
4	In [5.2.2] <b>Quiet operation schedule</b> , program when the unit has to use which quiet mode level. For more information about scheduling, see " <a href="#">3.1 Using and programming schedules</a> " [▶ 14].
5	Confirm with the ✓ button. <b>Result:</b> You return to the previous screen.
6	In [5.2] <b>Quiet operation</b> , confirm again with the ✓ button. <b>Result:</b> The possible outcomes for the quiet mode differ depending on the schedule (if programmed) and the restrictions (if defined). See below.

### To configure restrictions based on local regulations

(required permission level = installer)

1	Go to [5.2] <b>Settings &gt; Quiet operation</b> . <b>Note:</b> Tap on the <b>Outdoor</b> bar from the home screen to quickly access [5.2].
2	Tap <b>Scheduled</b> . <b>Result:</b> The following buttons appear: <ul style="list-style-type: none"> <li>▪ <b>Schedule</b></li> <li>▪ <b>Restrictions</b> (only for installers)</li> </ul>
3	Tap <b>Restrictions</b> .

<b>4</b>	In [5.2.8] <b>Restrictions</b> , define the restrictions (when day/night starts, and which quiet mode level to use during day/night):	
	▪ [5.2.9] <b>AM Restricted time</b>	Start of Day. <b>Example:</b> : At 6 a.m.
	▪ [5.2.10] <b>AM Restricted level</b>	Level used during the Day. <b>Example:</b> More quiet
	▪ [5.2.11] <b>PM Restricted time</b>	Start of Night. <b>Example:</b> : At 10 p.m.
	▪ [5.2.12] <b>PM Restricted level</b>	Level used during the Night. <b>Example:</b> Most quiet
<b>5</b>	Confirm and return with the ↩ button. <b>Result:</b> You return to the previous screen.	
<b>6</b>	In [5.2] <b>Quiet operation</b> , confirm again with the ✓ button. <b>Result:</b> The possible outcomes for the quiet mode differ depending on the schedule (if programmed) and the restrictions (if defined). See below.	

#### Possible outcomes when quiet mode is set to Scheduled

If...		Then quiet mode =...
Restrictions (time + level) defined?	Schedule programmed?	
No	No	OFF
	Yes	Follows schedule
Yes	No	Follows restriction
	Yes	The applicable level will be the most stringent one, which could either be the user-defined level in the schedule or the installer-defined restriction (e.g. 'most quiet' > 'quiet').

## 9.3 Using holiday mode

### About holiday mode

During your holiday, you can use the holiday mode to deviate from your normal schedules without having to change them. While holiday mode is active, space heating/cooling operation and domestic hot water operation will be turned off. Room frost protection, water pipe freeze prevention and disinfection operation will remain active.

### Typical workflow

Using holiday mode typically consists of the following stages:

- 1 Activating the holiday mode.
- 2 Setting the starting date and ending date of your holiday.

**To check if holiday mode is activated and/or running**

If  is displayed on the home screen, holiday mode is active.

**To configure the holiday**

Go to [5.27] **Settings > Holiday**, and do the following:

<b>1</b>	<p>To activate the holiday mode, switch [5.27.1] <b>Holiday mode</b> ON:</p> <div style="border: 1px solid gray; padding: 5px; margin: 5px 0;"> <p style="text-align: center;">Holiday mode <span style="float: right;"><input type="checkbox"/></span></p> </div>
<b>2</b>	<p>To define the holiday period:</p> <ul style="list-style-type: none"> <li>▪ Go to [5.27.2] <b>Holiday period</b>.</li> <li>▪ Under <b>From</b>, set the first day of your holiday.</li> <li>▪ Under <b>Till</b>, set the last day of your holiday.</li> <li>▪ Confirm with the  button.</li> </ul> <p><b>Note:</b> The holiday period starts at noon (12h00) of the first day, and ends at noon (12h00) of the last day.</p>

## 9.4 Using WLAN

 **INFORMATION**  
**Restriction:** WLAN settings are only visible when a WLAN cartridge is inserted in the user interface.

 **INFORMATION**  
 Only one cloud connection interface (WLAN/LAN) can be active at any given time. When using WLAN, it is NOT possible to use the LAN connection for connecting to the ONECTA cloud and vice versa. When switching from one connection interface to another, the interface must first be removed from the cloud (see [8.9] **Remove from cloud**).

**About the WLAN cartridge**

The WLAN cartridge connects the system to the internet. As user you can then control the system via the ONECTA app.

This needs the following components:

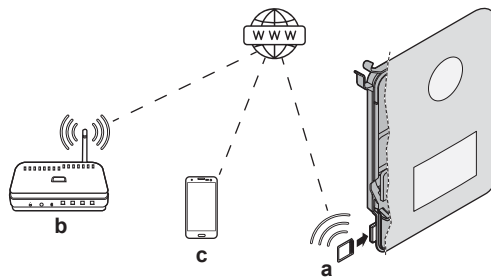

<b>a</b>	WLAN cartridge	The WLAN cartridge needs to be inserted in the user interface.
<b>b</b>	Router	Field supply.

<b>c</b>	Smartphone + app 	The ONECTA app needs to be installed on the user's smartphone. See: <a href="http://www.onlinecontroller.daikineurope.com/">http://www.onlinecontroller.daikineurope.com/</a> 
----------	---	---

### Configuration

To configure the ONECTA app, follow the in-app instructions. While doing this, the following actions and information are needed on the user interface:

- [8.3] **Wireless gateway**
  - [8.3.1] **Wireless gateway (ON/OFF)**
  - [8.3.2] **Enable AP mode**
  - [8.3.3] **Reboot the gateway**
  - [8.3.4] **WPS**
  - [8.3.5] **NOT USED**
  - [8.3.6] **Home network connection**
  - [8.3.7] **Reset to factory default**
- [8.10] **Connect to ONECTA cloud**

#### [8.3.1] Wireless gateway

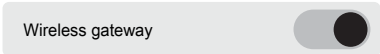
<b>1</b>	Go to [8.3.1]: <b>Wireless gateway &gt; Wireless gateway.</b>
<b>2</b>	<b>Remark: Wireless gateway</b> MUST be set to the ON position in order to connect to the ONECTA application. See [8.10] <b>Connect to ONECTA cloud.</b> 

#### [8.3.2] Enable AP mode

Make the WLAN cartridge active as access point:

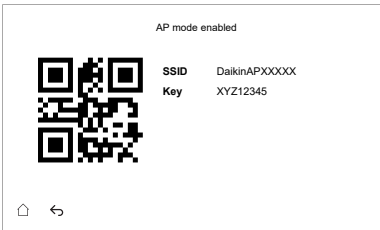
<b>1</b>	Go to [8.3.2]: <b>Wireless gateway &gt; Enable AP mode.</b>
<b>2</b>	This setting generates a random SSID and key (+ QR code) needed by the ONECTA app:  <p>Press one of the buttons to exit the screen.</p>

#### [8.3.3] Reboot the gateway

Reboot the WLAN cartridge:

<b>1</b>	Go to [8.3.3]: <b>Wireless gateway &gt; Reboot the gateway.</b>
<b>2</b>	In the <b>Reboot the gateway</b> screen, choose <b>Confirm</b> to reboot.

### [8.3.4] WPS

Connect the WLAN cartridge to the router:



#### INFORMATION

You can only use this function if it is supported by the software version of the WLAN, and the software version of the ONECTA app.

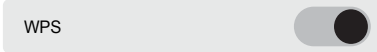
<b>1</b>	Go to [8.3.4]: <b>Wireless gateway</b> > <b>WPS</b> .
<b>2</b>	Switch <b>WPS ON</b> : 

### [8.3.5] NOT USED

### [8.3.6] Home network connection

Read out the status of the connection to the home network:

<b>1</b>	Go to [8.3.6]: <b>Wireless gateway</b> > <b>Home network connection</b> .
<b>2</b>	Read out the connection status: <ul style="list-style-type: none"> <li>▪ <b>Disconnected from</b> [WLAN_SSID]</li> <li>▪ <b>Connected to</b> [WLAN_SSID]</li> </ul>

### [8.3.7] Reset to factory default

Trigger to reset the WLAN cartridge to factory default (forget all network data):

<b>1</b>	Go to [8.3.7]: <b>Wireless gateway</b> > <b>Reset to factory default</b> .
<b>2</b>	Please confirm to reset to factory default. This action cannot be undone.

### [8.10] Connect to ONECTA cloud

Set the connection interface to connect to the ONECTA app:

<b>1</b>	Go to [8.10]: <b>Connectivity</b> > <b>Connect to ONECTA cloud</b> .
<b>2</b>	Press <b>Wireless gateway</b> . <b>Result:</b> The WLAN cartridge is set as the current cloud connection interface.
<b>3</b>	Continue the connection to the ONECTA app: <ul style="list-style-type: none"> <li>▪ Using [8.3.2] <b>Enable AP mode</b> ([8.3.4] <b>WPS</b>.is OFF). In this case, the WLAN cartridge is already made active as access point as described in [8.3.2] <b>Enable AP mode</b>.</li> <li>▪ Using [8.3.4] <b>WPS</b> ([8.3.4] <b>WPS</b>.is ON).</li> </ul>

## 9.5 Using LAN



#### INFORMATION



Only one cloud connection interface (WLAN/LAN) can be active at any given time. When using WLAN, it is NOT possible to use the LAN connection for connecting to the ONECTA cloud and vice versa. When switching from one connection interface to another, the interface must first be removed from the cloud (see [8.9] **Remove from cloud**).

### About the Ethernet cable (LAN)

An Ethernet cable (LAN) connects the system to the internet. As user you can then control the system via the ONECTA app.

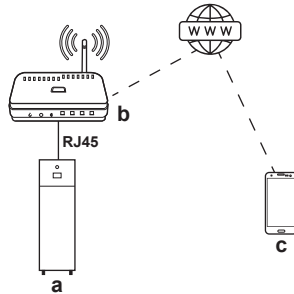
This needs the following components:



<b>a</b>	Daikin Altherma unit	Connected to the router via an Ethernet cable. For more information about the Ethernet cable (LAN) routing and connection, see the installer reference guide.
<b>b</b>	Router	Field supply.
<b>c</b>	Smartphone + app 	The ONECTA app needs to be installed on the user's smartphone. See: <a href="http://www.onlinecontroller.daikineurope.com/">http://www.onlinecontroller.daikineurope.com/</a> 

### Configuration

To configure the ONECTA app, follow the in-app instructions. While doing this, the following actions and information are needed on the user interface:

- [8.1] TCP/IP configuration
- [8.10] Connect to ONECTA cloud

#### [8.1] TCP/IP configuration

Define the IP settings.

<b>1</b>	By default, DHCP is set to ON. If you wish to modify IP settings first, disable DHCP and define the following: <ul style="list-style-type: none"> <li>▪ TCP/IP address</li> <li>▪ TCP/IP subnet mask</li> <li>▪ TCP/IP default gateway</li> <li>▪ TCP/IP DNS1</li> <li>▪ TCP/IP DNS2</li> </ul>
<b>2</b>	Press the confirm button to save the IP settings.

#### [8.10] Connect to ONECTA cloud

Select the connection interface to connect to the ONECTA app:

1	Go to [8.10]: <b>Connectivity &gt; Connect to ONECTA cloud.</b>
---	---

2 Press LAN cable.

**Result:** The LAN interface is set as the current cloud connection interface.  
The user interface redirects to [8.1] TCP/IP configuration.

# 10 Settings

## [1] Main zone

Main zone (mixed zone) = Zone with the lowest design temperature in heating, and the highest design temperature in cooling.

In this chapter

[1.1] Room setpoint .....	66
[1.2] Heating schedule enable.....	67
[1.3] Heating schedule .....	67
[1.4] Cooling schedule .....	68
[1.5] Heating setpoint mode .....	68
[1.6] Setpoint range: Heating / [1.43] Setpoint range: Cooling .....	68
[1.7] Cooling setpoint mode .....	71
[1.8] Heating WD curve .....	71
[1.9] Cooling WD curve .....	72
[1.10] Hysteresis .....	72
[1.11] Emitter type .....	73
[1.12] Control.....	74
[1.13] External room thermostat .....	74
[1.14] Delta T heating.....	75
[1.15] NOT USED .....	76
[1.16] Cooling allowance .....	76
[1.17] Enable zone.....	77
[1.18] Delta T cooling.....	77
[1.19] Overheating water circuit .....	77
[1.20] Undercooling water circuit.....	78
[1.21] Zone name .....	78
[1.22] Antifrost.....	78
[1.23] Cooling schedule enable.....	79
[1.24] Leaving water shift heating schedule .....	79
[1.25] Leaving water shift cooling schedule .....	80
[1.26] Increase around 0°C.....	81
[1.27] Leaving water shift heating.....	81
[1.28] Leaving water shift cooling.....	81
[1.29] Heating comfort setpoint .....	81
[1.30] Cooling comfort setpoint .....	82
[1.31] Daikin room thermostat.....	82
[1.32] Room enable.....	82
[1.33] External room sensor offset.....	83
[1.34] Heating target baseline.....	83
[1.35] Cooling target baseline.....	83
[1.36] Scheduled WD LWT shift for heating.....	83
[1.37] Scheduled WD LWT shift for cooling.....	84
[1.38] Thermostat sensor offset .....	84
[1.39] Leaving water temp. heating.....	84
[1.40] NOT USED .....	84
[1.41] NOT USED .....	84
[1.42] Leaving water temp. cooling.....	84
[1.43] Setpoint range: Cooling .....	85

### [1.1] Room setpoint

**Restriction:** Only applicable if [1.12] = Room.

Setpoint for the room temperature of the main zone. See "[2.4 Setpoint screen](#)" [▶ 13].

⚙️[N/A]	<p>Based on the active operation mode selected in [3.2] <b>Operation mode</b>, the room setpoint for either <b>Heating</b> or <b>Cooling</b> will be visible.</p> <p><b>Note:</b> In case the <b>Automatic</b> operation mode is selected, the schedule defined in [3.5] <b>Operation mode schedule</b> will be followed.</p> <p>For more details, see "<a href="#">[3.2] Operation mode</a>" [▶ 99] and "<a href="#">[3.5] Operation mode schedule</a>" [▶ 101].</p>
---------	---

## [1.2] Heating schedule enable

⚙️[N/A]	Activation screen for [1.3] <b>Heating schedule</b> .
<ul style="list-style-type: none"> <li>▪ If [1.12] = <b>Leaving water</b>, only the leaving water temperature schedule can be enabled/disabled: <ul style="list-style-type: none"> <li>- OFF (disabled)</li> <li>- ON (enabled)</li> </ul> </li> </ul> <p>The influence of the LWT setpoint mode [1.5] is as follows:</p> <ul style="list-style-type: none"> <li>▪ In <b>Fixed</b> LWT setpoint mode, the LWT schedules need to be selected. For more details, see "<a href="#">[1.3] Heating schedule</a>" [▶ 67].</li> </ul> <p><b>Note:</b> When <b>Fixed</b> setpoint mode is selected, the shift schedules are available, but will NOT have any effect.</p> <ul style="list-style-type: none"> <li>▪ In <b>Weather dependent</b> LWT setpoint mode, the shift schedules need to be selected. For more details, see "<a href="#">[1.24] Leaving water shift heating schedule</a>" [▶ 79].</li> </ul> <p><b>Note:</b> When <b>Weather dependent</b> setpoint mode is selected, the fixed schedules are available but will NOT have any effect.</p>	
<ul style="list-style-type: none"> <li>▪ If [1.12] = <b>External room thermostat</b>: <ul style="list-style-type: none"> <li>- No schedule is enabled.</li> </ul> </li> </ul>	
<ul style="list-style-type: none"> <li>▪ If [1.12] = <b>Room</b>, only the room temperature schedule can be enabled/disabled: <ul style="list-style-type: none"> <li>- OFF: Room temperature is directly controlled by the user.</li> <li>- ON: Room temperature is controlled by a schedule and can be modified by the user.</li> </ul> </li> </ul>	

## [1.3] Heating schedule

⚙️[N/A]	<p>Applicable for all models.</p> <p><b>Restriction:</b> Only applicable if [1.12] = <b>Leaving water</b> or <b>Room</b>.</p> <p>Schedule for the main zone in heating mode to set the desired leaving water or room temperature (depending on the installed system).</p>
---------	---

**Predefined schedules:** 3

**Activation screen:** [1.2] Heating schedule enable

**Possible actions:** Temperatures within range.

**Note:** In case of room temperature scheduling, the baseline temperature will be used at times when no temperature is scheduled (i.e. in between the schedule blocks). To set the baseline temperature, go to [1.34] **Main zone > Heating target baseline**.

**Note:** In case of LWT scheduling, operation will be OFF when no temperature is scheduled.

#### [1.4] Cooling schedule

⚙️[N/A]

**Restriction:** Only applicable for reversible models.

**Restriction:** Only applicable if [1.12] = **Leaving water** or **Room**.

Schedule for the main zone in cooling mode to set the desired leaving water or room temperature (depending on the installed system).

**Predefined schedules:** 1

**Activation screen:** [1.23] Cooling schedule enable

**Possible actions:** Temperatures within range.

**Note:** In case of room temperature scheduling, the baseline temperature will be used at times when no temperature is scheduled (i.e. in between the schedule blocks). To set the baseline temperature, go to [1.35] **Main zone > Cooling target baseline**.

**Note:** In case of LWT scheduling, operation will be OFF when no temperature is scheduled.

#### [1.5] Heating setpoint mode

⚙️[N/A]

Defines the setpoint mode for the main zone during space heating operation.

- 0: **Fixed:** The desired leaving water temperature does NOT depend on the outdoor ambient temperature.
- 1: **Weather dependent:** The desired leaving water temperature depends on the outdoor ambient temperature.

When weather-dependent operation is active, low outdoor temperatures will result in warmer water and vice versa. During weather-dependent operation, the user can shift the water temperature up or down by a maximum of 10°C. For more details, see "[\[1.27\] Leaving water shift heating](#)" [▶ 81].

#### [1.6] Setpoint range: Heating / [1.43] Setpoint range: Cooling

##### [1.6] Setpoint range: Heating

To prevent wrong too hot temperatures, you can limit the range of desired leaving water temperatures that users can set for the main zone in heating mode.

⚙️[053]	<b>Heating maximum<sup>(a)</sup>:</b> <ul style="list-style-type: none"> <li>▪ If [1.11] = Radiator: [054]°C~75°C</li> <li>▪ Else: [054]°C~55°C</li> </ul> <p><b>Note:</b> The temperature of the additional zone needs to be higher than the temperature of the main zone. If the heating maximum for the additional zone is lower, the main zone temperature will follow. For more details, see the field settings table of the installer reference guide.</p>
⚙️[054]	<b>Heating minimum:</b> <ul style="list-style-type: none"> <li>▪ 15°C~[053]°C</li> </ul>

<sup>(a)</sup> For more details, see "[\[3.12\] Overheating setpoint](#)" ▶ 104] and the field settings table of the installer reference guide.



## NOTICE

### Overheating limit

- Heat sources can be switched OFF when the maximum space heating setpoint (⚙️ [053] main zone, ⚙️[060] additional zone) is lower than: defrost cutout (35°C) + max delta T (a) + 2°C overshoot.
- In some cases, during a failed emitter defrost, this target temperature offset can be increased by an additional 5°C to increase the success rate after the failed defrost.



## NOTICE

The maximum setpoint range depends on the emitter type when a mixing kit or a bizon unit is connected. For more details, see configuration reference guide [1.11] **Emitter type**.

The minimum leaving water target for the heat pump and the backup heater is determined by the minimum water temperature required to initiate defrost. Even if a lower setpoint is selected, the minimum active setpoint will always be the defrost start temperature + the maximum target delta T + 1°C.

The maximum delta T is defined by the delta T of the main zone and the additional zone (see configuration reference guide [1.14] **Delta T heating** and [2.14] **Delta T heating**).

The values in the below graph are examples. For the details about the minimum required water temperature to start defrost, go to <https://daikintechnicaldatahub.eu/> to see the actual operation range drawing.

### Heating mode operation limits

#### 1. Zone (d):

- **Conditions:** When a setpoint is selected in this zone (d).
- **Result:** The backup heater target temperature is pushed to the blue line (c) + 1°C (= defrost line + target delta T (b) + 1°C) and the heat pump is NOT allowed to operate.

#### 2. Zone (e):

- **Conditions:** When a setpoint is selected in this zone (e).
- **Result:** The heat pump is forced off and the backup heater becomes the only active heat source for space heating towards the selected setpoint.

#### 3. Zone (f):

- **Conditions:** When a setpoint is selected in this zone (f)
- **Result:** The heat pump and backup heater target temperature are pushed to the blue line (c) + 1°C (= defrost line + maximum target delta T (a) + 1°C) and the heat pump is allowed to operate when the entering temperature is above the "minimum heat pump start-up limit" line.

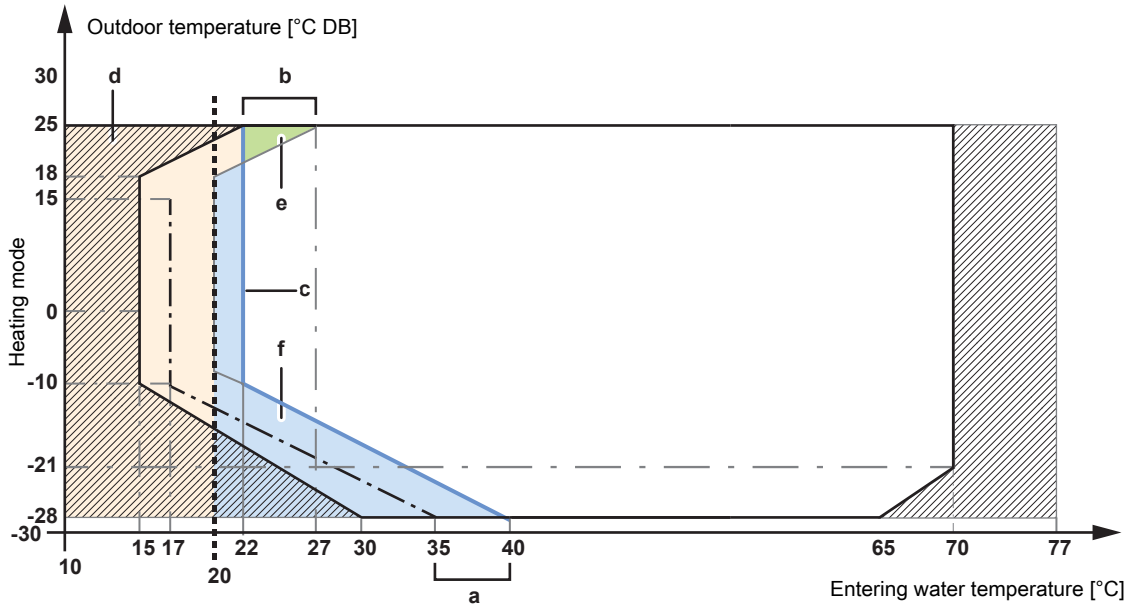

- Minimum heat pump start-up limit
- · - Minimum water temperature to start defrost
- - - Minimum setpoint 20°C
- ▨ Backup heater only operation
- a** Maximum target delta T
- b** Maximum target delta T
- c** Defrost line + target delta T
- d~f** Zone



**NOTICE**

In case of a floor heating application it is important to limit the maximum leaving water temperature at heating operation according to the specifications of the floor heating installation.



**NOTICE**

- When adjusting the leaving water temperature ranges, all desired leaving water temperatures are also adjusted to guarantee they are between the limits.
- Always balance between the desired leaving water temperature with the desired room temperature and/or the capacity (according to the design and selection of the heat emitters). The desired leaving water temperature is the result of several settings (preset values, shift values, weather-dependent curves, modulation). As a result, too high or too low leaving water temperatures could occur which lead to overtemperatures or capacity shortage. By limiting the leaving water temperature range to adequate values (depending on the heat emitter), such situations can be avoided.

**Example:** In heating mode, leaving water temperatures must be sufficiently higher than the room temperatures. To avoid that the room cannot heat up as desired, set the minimum leaving water temperature to 28°C.

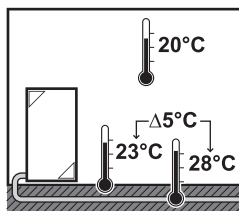

**[1.43] Setpoint range: Cooling**

To prevent wrong too cold temperatures, you can limit the range of desired leaving water temperatures that users can set for the main zone in cooling mode.

⚙️[055]	<b>Cooling maximum:</b> <ul style="list-style-type: none"> <li>▪ [056]°C~22°C</li> </ul>
⚙️[056]	<b>Cooling minimum<sup>(a)</sup>:</b> <ul style="list-style-type: none"> <li>▪ 7°C~[055]°C</li> </ul>

<sup>(a)</sup> For more details, see "[\[3.11\] Undercooling setpoint](#)" [▶ 103] and the field settings table of the installer reference guide.

**NOTICE**

In case of a floor heating application it is important to limit the minimum leaving water temperature at cooling operation to 18~20°C to prevent condensation on the floor.

**NOTICE**

- When adjusting the leaving water temperature ranges, all desired leaving water temperatures are also adjusted to guarantee they are between the limits.
- Always balance between the desired leaving water temperature with the desired room temperature and/or the capacity (according to the design and selection of the heat emitters). The desired leaving water temperature is the result of several settings (preset values, shift values, weather-dependent curves, modulation). As a result, too high or too low leaving water temperatures could occur which lead to overtemperatures or capacity shortage. By limiting the leaving water temperature range to adequate values (depending on the heat emitter), such situations can be avoided.

**[1.7] Cooling setpoint mode**

⚙️[N/A]	Defines the setpoint mode for the main zone during space cooling operation.
	<ul style="list-style-type: none"> <li>▪ <b>0: Fixed:</b> The desired leaving water temperature does NOT depend on the outdoor ambient temperature.</li> <li>▪ <b>1: Weather dependent:</b> The desired leaving water temperature depends on the outdoor ambient temperature.</li> </ul>

When weather-dependent operation is active, low outdoor temperatures will result in warmer water and vice versa. During weather-dependent operation, the user can shift the water temperature up or down by a maximum of 10°C. For more details, see "[\[1.28\] Leaving water shift cooling](#)" [▶ 81].

**[1.8] Heating WD curve**

⚙️[N/A]	Defines the weather-dependent curve used to determine the leaving water temperature of the main zone in space heating operation.
	<b>Restriction:</b> The curve is only used when [1.5] = <b>Weather dependent</b> .
See " <a href="#">4 Weather-dependent curve</a> " [▶ 26].	

The weather-dependent heating can be configured according to the figure below.

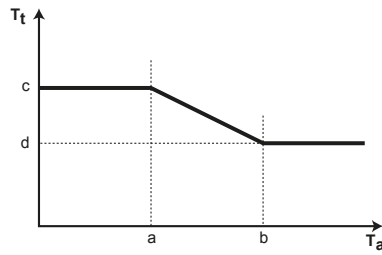

- T<sub>t</sub>** Target leaving water temperature (main zone)
- T<sub>a</sub>** Outdoor temperature
- a** Low outdoor ambient temperature. -40°C~+5°C
- b** High outdoor ambient temperature. 5°C~25°C
- c** Desired leaving water temperature when the outdoor temperature equals or drops below the low ambient temperature. [054]°C~[053]°C  
**Note:** This value should be higher than (d) as for low outdoor temperatures warmer water is required.
- d** Desired leaving water temperature when the outdoor temperature equals or rises above the high ambient temperature. [054]°C~[053]°C  
**Note:** This value should be lower than (c) as for high outdoor temperatures less warm water is required.

[1.9] Cooling WD curve

[N/A]	Defines the weather-dependent curve used to determine the leaving water temperature of the main zone in space cooling operation.  <b>Restriction:</b> The curve is only used when [1.7] = <b>Weather dependent</b> .
See " <a href="#">4 Weather-dependent curve</a> " [▶ 26].	

The weather-dependent cooling can be configured according to the figure below.

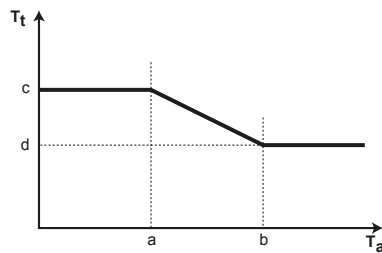

- T<sub>t</sub>** Target leaving water temperature (main zone)
- T<sub>a</sub>** Outdoor temperature
- a** Low outdoor ambient temperature. 10°C~25°C
- b** High outdoor ambient temperature. 25°C~43°C
- c** Desired leaving water temperature when the outdoor temperature equals or drops below the low ambient temperature. [056]°C~[055]°C  
**Note:** This value should be higher than (d) as for low outdoor temperatures less cold water is required.
- d** Desired leaving water temperature when the outdoor temperature equals or rises above the high ambient temperature. [056]°C~[055]°C

[1.10] Hysteresis

[N/A]	<b>Restriction:</b> Only applicable if [1.12] = <b>Room</b> .  Hysteresis on the room target temperature used to restart the request for space heating or cooling.
<ul style="list-style-type: none"> <li>▪ The hysteresis band around the desired room temperature can be adjusted.</li> <li>▪ 0.5°C~10°C</li> </ul> <b>Note:</b> It is recommended NOT to change the room temperature hysteresis as it is set for optimal use of the system.	

**Example:**

If...	Then...
<ul style="list-style-type: none"> <li>Room <b>heating</b> target: 20°C</li> <li>Hysteresis value: 0.5°C</li> </ul>	<ul style="list-style-type: none"> <li>Operation starts at: 19.5°C</li> <li>Operation stops at: 20.5°C</li> </ul>
<ul style="list-style-type: none"> <li>Room <b>cooling</b> target: 18°C</li> <li>Hysteresis value: 0.5°C</li> </ul>	<ul style="list-style-type: none"> <li>Operation starts at: 18.5°C</li> <li>Operation stops at: 17.5°C</li> </ul>

**[1.11] Emitter type**

⚙️[N/A]	Must match your system layout. Emitter type of the main zone.
<ul style="list-style-type: none"> <li>0: Under floor heating</li> <li>1: Heat pump convector</li> <li>2: Radiator</li> </ul>	

The setting **Emitter type** influences the space heating setpoint range and the target delta T in heating as follows:

Emitter type Main zone	Space heating setpoint range [054]~[053] <sup>(a)</sup>	Target delta T in heating
0: Under floor heating	Maximum 55°C	3°C~10°C (see " [1.14] Delta T heating" [▶ 75], ⚙️ [169])
1: Heat pump convector	Maximum 55°C	3°C~10°C (see " [1.14] Delta T heating" [▶ 75], ⚙️ [169])
2: Radiator	Maximum 75°C	10°C~20°C (see " [1.14] Delta T heating" [▶ 75], ⚙️ [170])

<sup>(a)</sup> This column only explains the maximum setpoint range. For more details about the setpoint range, see " [1.6] Setpoint range: Heating / [1.43] Setpoint range: Cooling" [▶ 68].

**Remark:** When changing the emitter type from **Under floor heating** or **Heat pump convector** to **Radiator**, the maximum setpoint range will NOT automatically adapt to 75°C. If required, it needs to be manually increased again.

**INFORMATION**

The setpoint of the main zone is limited by the setpoint of the additional zone during heating operation. The setpoint of the main zone can NEVER be higher than the setpoint of the additional zone.

Heating up or cooling down the main zone can take longer. This depends on:

- The water volume of the system
- The heater emitter type of the main zone

The setting **Emitter type** can compensate for a slow or a quick heating/cooling system during the heat up/cool down cycle.

It is important to set **Emitter type** correctly and in accordance with your system layout. The target delta T for the main zone depends on it.

**NOTICE**

NOT configuring the system in the following way can cause damage to the heat emitters. If there are 2 zones, it is important that in heating:

- the zone with the lowest water temperature is configured as the main zone, and
- the zone with the highest water temperature is configured as the additional zone.

**NOTICE**

If there are 2 zones and the emitter types are wrongly configured, water of high temperature can be sent towards a low temperature emitter (underfloor heating). To avoid this:

- Install an aquastat/thermostatic valve to avoid too high temperatures towards a low temperature emitter.
- Make sure you set the emitter types for the main zone [1.11] and for the additional zone [2.11] correctly in accordance with the connected emitter.

**NOTICE**

**Average emitter temperature** = Leaving water temperature – (Delta T)/2

This means that for a same leaving water temperature setpoint, the average emitter temperature of radiators is lower than that of underfloor heating because of a bigger delta T.

Example radiators:  $40 - 10 / 2 = 35^{\circ}\text{C}$

Example underfloor heating:  $40 - 5 / 2 = 37.5^{\circ}\text{C}$

To compensate, you can increase the weather-dependent curve desired temperatures.

## [1.12] Control

⚙️[041]	Defines the unit control method for the main zone.
<ul style="list-style-type: none"> <li>▪ <b>0: Leaving water:</b> Unit operation is decided based on the leaving water temperature regardless the actual room temperature and/or heating or cooling demand of the room.</li> <li>▪ <b>1: External room thermostat:</b> Unit operation is decided by the external thermostat or equivalent (e.g. heat pump convector). In case of external room thermostat control, you must also set the external room thermostat type with setting [1.13] (see " [1.13] External room thermostat" ▶ 74).</li> <li>▪ <b>2: Room:</b> Unit operation is decided based on the ambient temperature of the dedicated Human Comfort Interface (BRC1HHDA used as room thermostat).</li> </ul>	

## [1.13] External room thermostat

**Note:** To be used in combination with [1.12] = External room thermostat.

**NOTICE**

**External room thermostat requests.** You can define the external room thermostat requests in different ways:

**1. Via hardware:**

- Install an external room thermostat.
- Go to **External room thermostat** ([1.13] for main zone or [2.13] for additional zone).
- Set **Input source** = **Hardware**.
- In the selection box **Connection type**, select which external room thermostat type you used (**Single contact** or **Dual contact**).

**2. Via Modbus:**

- Go to **External room thermostat** ([1.13] for main zone or [2.13] for additional zone).
- Set **Input source** = **External**.
- Main zone: Use holding register 74: Thermostat request Main.
- Additional zone: Use holding register 75: Thermostat request Add.

**3. Via Cloud:** Momentarily, only available for business-to-business integrators. For more information, see <https://developer.cloud.daikinurope.com>.

- Go to **External room thermostat** ([1.13] for main zone or [2.13] for additional zone).
- Set **Input source** = **External**.
- Use the ONECTA cloud API to adjust the external room thermostat requests.

**Input source**

⚙️[180]	Must match your system layout. Input source of the external room thermostat for the main zone.
<ul style="list-style-type: none"> <li>▪ 0: <b>Hardware</b>: For external room thermostat connected to the unit.</li> <li>▪ 1: <b>External</b>: For Cloud and Modbus.</li> </ul>	

**Connection type**

⚙️[042]	<p><b>Restriction:</b> Only applicable if [1.13] <b>Input source</b> = <b>Hardware</b>.</p> <p>Must match your system layout. External room thermostat type for the main zone.</p>
<ul style="list-style-type: none"> <li>▪ 1: <b>Single contact</b>: The used external room thermostat can only send a thermo ON/OFF condition. There is no separation between heating or cooling demand. Select this value in case of a connection to the heat pump convector (FWX*).</li> <li>▪ 0: <b>Dual contact</b>: The used external room thermostat can send a separate heating/cooling thermo ON/OFF condition. Select this value in case of connection to multi-zoning wired controls, wired room thermostats (EKRTWA) or wireless room thermostats (EKRTTB).</li> </ul>	

**NOTICE**

If an external room thermostat is used, the external room thermostat will control the room frost protection.

**[1.14] Delta T heating**

A minimum temperature difference is required for proper operation of heat emitters in heating mode.

⚙️[169]	<ul style="list-style-type: none"> <li>If [1.11] = <b>Under floor heating</b> or <b>Heat pump convector</b>, the range is 3°C~10°C.</li> </ul>
⚙️[170]	<ul style="list-style-type: none"> <li>If [1.11] = <b>Radiator</b>, the range is 10°C~20°C.</li> </ul>

### About delta T

In heating for the main zone, the target delta T (temperature difference) depends on the selected emitter type for the main zone.

Delta T is the absolute value of the temperature difference between the leaving water and entering water.

The unit is designed to support underfloor loops operation. The recommended leaving water temperature for underfloor loops is 35°C. In such case, the unit will realize a temperature difference of 5°C, which means that the entering water temperature is around 30°C.

Depending on the installed type of heat emitters (radiators, heat pump convector, underfloor loops) or situation, you can change the difference between entering and leaving water temperature.

**Note:** The pump will regulate its flow to keep the delta T. In some special cases, the measured delta T can differ from the set value.



#### INFORMATION

In heating, the target delta T will only be achieved after some operation time, when the setpoint is being reached, because of the big difference between leaving water temperature setpoint and inlet temperature at startup.



#### INFORMATION

If the main zone or the additional zone has a heating demand, and this zone is equipped with radiators, then the target delta T that the unit will use in heating operation will be within the 10°C~20°C range.

[1.15] NOT USED

### [1.16] Cooling allowance

⚙️[050]	Allows/disallows cooling operation in the main zone.
	<ul style="list-style-type: none"> <li>0: No (disallowed): The cooling request for the main zone will be ignored. <ul style="list-style-type: none"> <li>If a shut-off valve is connected to the main zone, it will close.</li> <li>If an external pump is connected to the main zone, it will be switched OFF during cooling operation preventing cold water from entering the main zone.</li> </ul> </li> <li>1: Yes (allowed): The cooling request for the main zone is NOT influenced. <ul style="list-style-type: none"> <li>If a shut-off valve is connected to the main zone, it will remain open.</li> <li>If an external pump is connected to the main zone, it will remain operational during cooling operation.<sup>(a)</sup></li> </ul> </li> </ul>

<sup>(a)</sup> The external pump or the pump connected to the mixing kit of the main zone will stop if the request of that zone drops or if cooling is requested. For more details, see "[13](#) Field IO" [[▶ 159](#)] and the application guidelines chapter of the installer reference guide.

### Shut-off valve or pump use cases

For more information about shut-off valve or pump use cases, see the application guidelines chapter of the installer reference guide.

### To connect the shut-off valve or the pump

For more information about how to connect the shut-off valve or the pump, see "[13] Field IO" [▶ 159] and the electrical installation chapter of the installer reference guide.

For more details about the configuration per setup type, see the application guidelines chapter of the installer reference guide.

#### [1.17] Enable zone

⚙️[N/A]	<b>Restriction:</b> Only applicable if [1.12] = <b>Leaving water</b> . Turns ON/OFF the main zone and allows space heating operation.
<ul style="list-style-type: none"> <li>▪ OFF (disabled)</li> <li>▪ ON (enabled)</li> </ul>	

#### [1.18] Delta T cooling

⚙️[174]	A minimum temperature difference is required for proper operation of heat emitters in cooling mode.
<ul style="list-style-type: none"> <li>▪ 3°C~10°C</li> </ul>	

#### About delta T

Delta T is the absolute value of the temperature difference between the leaving water and entering water.

The unit is designed to support underfloor loops operation. The recommended leaving water temperature for underfloor loops is around 18°C~20°C. In such case, the unit will realize a temperature difference of 5°C, which means that the entering water temperature is around 23°C~25°C.

**Note:** Make sure that the setpoint temperature remains above the dew point to prevent condensation and potential moisture damage to the floor.

Depending on the installed type of heat emitters (radiators, heat pump convector, underfloor loops) or situation, you can change the difference between entering and leaving water temperature.

**Note:** The pump will regulate its flow to keep the delta T. In some special cases, the measured delta T can differ from the set value.



#### INFORMATION

In cooling, the target delta T will only be achieved after some operation time, when the setpoint is being reached, because of the big difference between leaving water temperature setpoint and inlet temperature at startup.

#### [1.19] Overheating water circuit

⚙️[048]	<b>Restriction:</b> Only applicable if [3.13.5] = Yes. Defines the maximum leaving water temperature in the main zone with respect to the installed emitter.
<ul style="list-style-type: none"> <li>▪ 20°C~80°C</li> </ul>	

**INFORMATION**

The maximum leaving water temperature is decided based on setting [3.12] **Overheating setpoint**. This limit defines the maximum leaving water **in the system**. Depending on the value of this setting, the maximum LWT setpoint will also be reduced by 5°C to allow stable control towards the setpoint.

The maximum leaving water temperature **in the main zone** is decided based on setting [1.19] **Overheating water circuit**, only in case [3.13.5] **Bizone kit installed** is enabled. This limit defines the maximum leaving water **in the main zone**. Depending on the value of this setting, the maximum LWT setpoint will also be reduced by 5°C to allow stable control towards the setpoint.

**[1.20] Undercooling water circuit**

[049]

**Restriction:** Only applicable if [3.13.5] = Yes.

Defines the minimum leaving water temperature in the main zone with respect to the installed emitter.

- 3°C~35°C

**INFORMATION**

The minimum leaving water temperature is decided based on setting [3.11] **Undercooling setpoint**. This limit defines the minimum leaving water **in the system**. Depending on the value of this setting, the minimum LWT setpoint will also be increased by 4°C to allow stable control towards the setpoint.

The minimum leaving water temperature **in the main zone** is decided based on setting [1.20] **Undercooling water circuit**, only in case [3.13.5] **Bizone kit installed** is enabled. This limit defines the minimum leaving water **in the main zone**. Depending on the value of this setting, the minimum LWT setpoint will also be increased by 4°C to allow stable control towards the setpoint.

**[1.21] Zone name**

[N/A]

Use this setting to change the name of the main zone.

- The zone name is limited to 16 characters.

**[1.22] Antifrost**

**Antifrost** prevents the room from getting too cold.

In all cases, for the main and additional zone, **Antifrost** will heat the space heating water to a reduced setpoint when the outdoor temperature is lower than 6°C. This will be decided by the lowest ambient temperature measured by the external outdoor ambient temperature sensor or if connected, an optional ambient temperature sensor.

For the main zone: when [3.4] is enabled, antifrost prevents the room from getting below the [1.22] **Antifrost** setpoint. This setting is applicable when [1.12] **Control** = **Room**, but also offers functionality for leaving water temperature control and external room thermostat control.

**Note:** In case of thermostat cable breakdown, room frost protection cannot be guaranteed.

**Note:** In all cases the antifrost can be activated via breadcrumb [3.4] (also for **Leaving water** or **External room thermostat** control).

[1.12] Main zone > Control	Description
Leaving water	Room frost protection is guaranteed via reduced leaving water temperature setpoint, in case the water zone is switched OFF.
External room thermostat	Room frost protection is guaranteed via reduced leaving water temperature setpoint when there is a thermostat request, in case the water zone is switched OFF.
Room (main zone only)	Allow for the dedicated Human Comfort Interface (BRC1HHDA used as room thermostat) to take care of room frost protection:  Set the temperature of the antifrost function in [1.22] <b>Antifrost</b> .

### [1.23] Cooling schedule enable

⚙️[N/A]	Activation screen for [1.4] <b>Cooling schedule</b> .
	<ul style="list-style-type: none"> <li>▪ If [1.12] = <b>Leaving water</b>, only the leaving water temperature schedule can be enabled/disabled: <ul style="list-style-type: none"> <li>▪ OFF (disabled)</li> <li>▪ ON (enabled)</li> </ul> </li> </ul> <p>The influence of the LWT setpoint mode [1.7] is as follows:</p> <ul style="list-style-type: none"> <li>▪ In <b>Fixed</b> LWT setpoint mode, the LWT schedules need to be selected. For more details, see " [1.4] <b>Cooling schedule</b>" [▶ 68].</li> <li>▪ <b>Note:</b> When <b>Fixed</b> setpoint mode is selected, the shift schedules are available, but will NOT have any effect.</li> <li>▪ In <b>Weather dependent</b> LWT setpoint mode, the shift schedules need to be selected. For more details, see " [1.25] <b>Leaving water shift cooling schedule</b>" [▶ 80].</li> <li>▪ <b>Note:</b> When <b>Weather dependent</b> setpoint mode is selected, the fixed schedules are available but will NOT have any effect.</li> </ul>
	<ul style="list-style-type: none"> <li>▪ If [1.12] = <b>External room thermostat</b>: <ul style="list-style-type: none"> <li>- No schedule is enabled.</li> </ul> </li> </ul>
	<ul style="list-style-type: none"> <li>▪ If [1.12] = <b>Room</b>, only the room temperature schedule can be enabled/disabled: <ul style="list-style-type: none"> <li>- OFF: Room temperature is directly controlled by the user.</li> <li>- ON: Room temperature is controlled by a schedule and can be modified by the user.</li> </ul> </li> </ul>

### [1.24] Leaving water shift heating schedule

⚙️[N/A]	<p><b>Restriction:</b> Only applicable if:</p> <ul style="list-style-type: none"> <li>▪ [1.12] = <b>Leaving water</b>, and</li> <li>▪ [1.5] = <b>Weather dependent</b>.</li> </ul> <p>Schedule of the leaving water temperature target shift on the weather-dependent curve during space heating operation in the main zone.</p>
---------	--

- **Predefined schedules:** 3
  - **Activation:** [1.36] Scheduled WD LWT shift for heating
  - **Possible actions:** Leaving water shift temperatures on the weather-dependent curve.
- Note:** Only in case weather-dependent curve is used (see "4 Weather-dependent curve" [▶ 26]).
- You can schedule 10 actions per day.

This setting enables to apply a temperature shift for a certain time during space heating operation in the main zone. Its value will increase or decrease the value of the weather-dependent curve according to a value selected in a schedule.

**Example:**

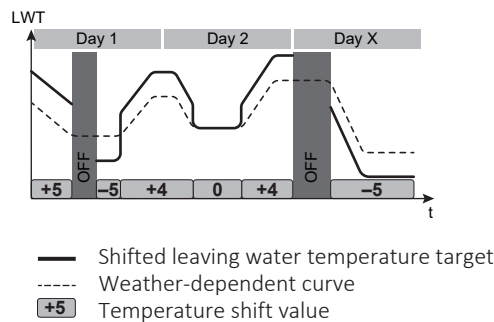

**Remark:** In case of LWT shift scheduling, there will be **NO operation** at times when no temperature shift is scheduled.

[1.25] Leaving water shift cooling schedule

- |   |  |
|---|--|
| <p>⚙️[N/A]</p>  | <p><b>Restriction:</b> Only applicable if:</p> <ul style="list-style-type: none"> <li>▪ [1.12] = Leaving water, and</li> <li>▪ [1.7] = Weather dependent.</li> </ul> <p>Schedule of the leaving water temperature target shift on the weather-dependent curve during space cooling operation in the main zone.</p> |
| <ul style="list-style-type: none"> <li>▪ <b>Predefined schedules:</b> 1</li> <li>▪ <b>Activation:</b> [1.37] Scheduled WD LWT shift for cooling</li> <li>▪ <b>Possible actions:</b> Leaving water shift temperatures on the weather-dependent curve.</li> </ul> <p><b>Note:</b> Only in case weather-dependent curve is used (see "4 Weather-dependent curve" [▶ 26]).</p> <ul style="list-style-type: none"> <li>▪ You can schedule 10 actions per day.</li> </ul> |  |

This setting enables to apply a temperature shift for a certain time during space cooling operation in the main zone. Its value will increase or decrease the value of the weather-dependent curve according to a value selected in a schedule.

**Example:**

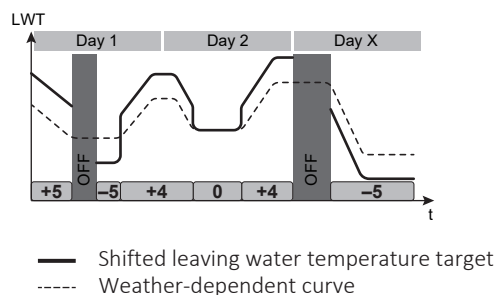

**+5** Temperature shift value

**Remark:** In case of LWT shift scheduling, there will be **NO operation** at times when no temperature shift is scheduled.

### [1.26] Increase around 0°C

<p>⚙️[052]</p>	<p>For main zone.</p> <p>Use this setting to compensate for possible heat losses of the building due to the evaporation of melted ice or snow. (e.g. in cold region countries). In heating operation, the desired leaving water temperature is locally increased around an outdoor temperature of 0°C. This compensation can be selected when using an absolute or a weather-dependent desired temperature (see illustration below).</p> <div style="text-align: center;"> </div> <p><b>a:</b> Absolute desired leaving water temperature  <b>b:</b> Weather-dependent desired leaving water temperature  <b>L:</b> Increase; <b>R:</b> Span; <b>X:</b> Outdoor temperature; <b>Y:</b> Leaving water temperature</p>
	<ul style="list-style-type: none"> <li>▪ 0: No</li> <li>▪ 1: increase 2°C, span 4°C</li> <li>▪ 2: increase 2°C, span 8°C</li> <li>▪ 3: increase 4°C, span 4°C</li> <li>▪ 4: increase 4°C, span 8°C</li> </ul>

### [1.27] Leaving water shift heating

<p>⚙️[N/A]</p>	<p><b>Restriction:</b> Only applicable if [1.5] = <b>Weather dependent</b>.</p> <p>The shift of the selected setpoint to the weather-dependent curve for the leaving water temperature of the main zone in heating operation.</p>
	<ul style="list-style-type: none"> <li>▪ -10°C~10°C</li> </ul> <p><b>Remark:</b> This setting can overrule [1.24] <b>Leaving water shift heating schedule</b> until the next scheduled shift trigger occurs.</p>

### [1.28] Leaving water shift cooling

<p>⚙️[N/A]</p>	<p><b>Restriction:</b> Only applicable if [1.7] = <b>Weather dependent</b>.</p> <p>The shift of the selected setpoint to the weather-dependent curve for the leaving water temperature of the main zone in cooling operation.</p>
	<ul style="list-style-type: none"> <li>▪ -10°C~10°C</li> </ul> <p><b>Remark:</b> This setting can overrule [1.25] <b>Leaving water shift cooling schedule</b> until the next scheduled shift trigger occurs.</p>

### [1.29] Heating comfort setpoint

**Restriction:** Only applicable if:

- [1.12] = Room, and

- Smart Grid is enabled [9.14.1] = **Smart Grid ready contacts**.

If room buffering is enabled, the extra energy from photovoltaic panels is buffered in the DHW tank and in the space heating/cooling circuit (i.e. heat up or cool down the room). With the room comfort setpoints (cooling/heating) you can modify the maximum/minimum setpoints that will be used when buffering the extra energy in the space heating/cooling circuit.

⚙️[N/A]	Defines the target room temperature that will be used when buffering the extra energy in the space heating/cooling circuit during heating operation.
<ul style="list-style-type: none"> <li>▪ 12°C~30°C</li> </ul>	



#### INFORMATION

During the **Forced on** mode, the room buffering will happen independently from the **Allow buffering space H/C** [9.14.4] setting. During the **Recommended on** mode, the room buffering will only happen when the room buffering is enabled ([9.14.4] = On).

### [1.30] Cooling comfort setpoint

**Restriction:** Only applicable if:

- [1.12] = **Room**, and
- Smart Grid is enabled [9.14.1] = **Smart Grid ready contacts**.

If room buffering is enabled, the extra energy from photovoltaic panels is buffered in the DHW tank and in the space heating/cooling circuit (i.e. heat up or cool down the room). With the room comfort setpoints (cooling/heating) you can modify the maximum/minimum setpoints that will be used when buffering the extra energy in the space heating/cooling circuit.

⚙️[N/A]	Defines the target room temperature that will be used when buffering the extra energy in the space heating/cooling circuit during cooling operation.
<ul style="list-style-type: none"> <li>▪ 15°C~35°C</li> </ul>	



#### INFORMATION

During the **Forced on** mode, the room buffering will happen independently from the **Allow buffering space H/C** [9.14.4] setting. During the **Recommended on** mode, the room buffering will only happen when the room buffering is enabled ([9.14.4] = On).

### [1.31] Daikin room thermostat

⚙️[158]	Indicates whether the room thermostat is installed or not.
<ul style="list-style-type: none"> <li>▪ 0: No</li> <li>▪ 1: Yes</li> </ul>	

This setting is automatically enabled when the room thermostat is connected. It should be disabled when the room thermostat is removed from the setup.

### [1.32] Room enable

⚙️[N/A]	Enables/disables the room temperature control in the main zone.
---------	---

- OFF (disabled)
- ON (enabled)

### [1.33] External room sensor offset

⚙️[N/A]	<p><b>Restriction:</b> Only applicable if [1.12] = Room.</p> <p>Optional offset that can be applied to the room temperature target, measured by the optional sensor in the main zone.</p> <p>Same as setting [5.22] <b>External ambient sensor offset &gt; Room</b>.</p>
	<ul style="list-style-type: none"> <li>▪ -5~5°C</li> </ul> <p>It is linked to the external room sensor selected via [13] <b>Field IO</b>. For more information, see "<a href="#">[13] Field IO</a>" [▶ 159] and the installer reference guide.</p>

### [1.34] Heating target baseline

⚙️[N/A]	<p><b>Restriction:</b> Only applicable if [1.12] = Room.</p> <p>Setpoint for the room target baseline temperature for the room schedule during space heating operation in the main zone.</p>
	<ul style="list-style-type: none"> <li>▪ If [1.2] = ON, the room target temperature will follow a block-based schedule set in [1.3] (see "<a href="#">[1.3] Heating schedule</a>" [▶ 67]). When no temperature is scheduled, the room target temperature will follow the baseline temperature.</li> <li>▪ If [1.2] = OFF, the room target temperature will follow the room setpoint set in [1.1].</li> </ul>

### [1.35] Cooling target baseline

⚙️[N/A]	<p><b>Restriction:</b> Only applicable if [1.12] = Room.</p> <p>Setpoint for the room target baseline temperature for the room schedule during space cooling operation in the main zone.</p>
	<ul style="list-style-type: none"> <li>▪ If [1.2] = ON, the room target temperature will follow a block-based schedule set in [1.4] (see "<a href="#">[1.4] Cooling schedule</a>" [▶ 68]). When no temperature is scheduled, the room target temperature will follow the baseline temperature.</li> <li>▪ If [1.2] = OFF, the room target temperature will follow the room setpoint set in [1.1].</li> </ul>

### [1.36] Scheduled WD LWT shift for heating

⚙️[N/A]	<p><b>Restriction:</b> Only applicable if:</p> <ul style="list-style-type: none"> <li>▪ [1.12] = Leaving water, and</li> <li>▪ [1.5] = Weather dependent.</li> </ul> <p>Activation screen for [1.24] <b>Leaving water shift heating schedule</b> (see "<a href="#">[1.24] Leaving water shift heating schedule</a>" [▶ 79]). Enables/disables a temperature shift on the weather-dependent leaving water target during space heating operation in the main zone.</p>
---------	--

- ON (enabled)
- OFF (disabled)

**Note:** When the weather-dependent setpoint mode is active, the fixed schedules remain selectable, but will NOT have any effect. The leaving water temperature is then NOT controlled by the setting [1.39] **Leaving water temp. heating**.

### [1.37] Scheduled WD LWT shift for cooling

⚙️[N/A]	<p><b>Restriction:</b> Only applicable if:</p> <ul style="list-style-type: none"> <li>▪ [1.12] = <b>Leaving water</b>, and</li> <li>▪ [1.7] = <b>Weather dependent</b>.</li> </ul> <p>Activation screen for [1.25] <b>Leaving water shift cooling schedule</b> (see "[1.25] <b>Leaving water shift cooling schedule</b>" [▶ 80]). Enables/disables a temperature shift on the weather-dependent leaving water target during space cooling operation in the main zone.</p>
<ul style="list-style-type: none"> <li>▪ ON (enabled)</li> <li>▪ OFF (disabled)</li> </ul> <p><b>Note:</b> When the weather-dependent setpoint mode is active, the fixed schedules remain selectable, but will NOT have any effect. The leaving water temperature is then NOT controlled by the setting [1.42] <b>Leaving water temp. cooling</b>.</p>	

### [1.38] Thermostat sensor offset

⚙️[N/A]	<p><b>Restriction:</b> Only applicable if [1.12] = <b>Room</b>.</p> <p>Offset on the room temperature on the Human Comfort Interface in the main zone.</p>
<ul style="list-style-type: none"> <li>▪ -5°C~5°C</li> </ul>	

For more information, see also "[1.31] **Daikin room thermostat**" [▶ 82].

### [1.39] Leaving water temp. heating

⚙️[N/A]	<p>Setpoint for the desired leaving water temperature during space heating of the main zone.</p> <p><b>Note:</b> In case of weather-dependent mode, LWT is not controlled by this setting.</p>
[054]°C~[053]°C	

### [1.40] NOT USED

### [1.41] NOT USED

### [1.42] Leaving water temp. cooling

⚙️[N/A]	<p>Setpoint for the desired leaving water temperature during space cooling of the main zone.</p> <p><b>Note:</b> In case of weather-dependent mode, LWT is not controlled by this setting.</p>
[056]°C~[055]°C	

### [1.43] Setpoint range: Cooling

See " [1.6] Setpoint range: Heating / [1.43] Setpoint range: Cooling" [▶ 68]

## [2] Additional zone

Additional zone (direct zone) = Zone with the highest design temperature in heating, and the lowest design temperature in cooling.

**Restriction:** You can configure the settings for the additional zone ONLY after enabling the additional zone with setting [3.6] = Yes.

In this chapter

[2.1] NOT USED .....	86
[2.2] Heating schedule enable.....	86
[2.3] Heating schedule .....	87
[2.4] Cooling schedule .....	87
[2.5] Heating setpoint mode .....	87
[2.6] Setpoint range: Heating / [2.37] Setpoint range: Cooling.....	88
[2.7] Cooling setpoint mode .....	90
[2.8] Heating WD curve .....	90
[2.9] Cooling WD curve .....	91
[2.10] NOT USED .....	91
[2.11] Emitter type .....	91
[2.12] Control.....	92
[2.13] External room thermostat .....	92
[2.14] Delta T heating.....	93
[2.15] Enable zone.....	94
[2.16] NOT USED .....	94
[2.17] Delta T cooling.....	94
[2.18] Leaving water shift heating schedule .....	94
[2.19] Leaving water shift cooling schedule .....	95
[2.20] Increase around 0°C.....	96
[2.21] Zone name .....	96
[2.22] Leaving water shift heating.....	96
[2.23] Leaving water shift cooling.....	96
[2.24] NOT USED .....	97
[2.25] NOT USED .....	97
[2.26] NOT USED .....	97
[2.27] Cooling schedule enable.....	97
[2.28] NOT USED .....	97
[2.29] NOT USED .....	97
[2.30] Leaving water temp. heating.....	97
[2.31] Scheduled WD LWT shift for heating.....	97
[2.32] Scheduled WD LWT shift for cooling.....	98
[2.33] Cooling allowance .....	98
[2.34] NOT USED .....	98
[2.35] NOT USED .....	98
[2.36] Leaving water temp. cooling.....	98
[2.37] Setpoint range: Cooling .....	98

[2.1] NOT USED

[2.2] Heating schedule enable

⚙️ [N/A]	<p><b>Restriction:</b> Only applicable if [1.12] = Leaving water. Activation screen for [2.3] Heating schedule.</p>
----------	---

The influence of the LWT setpoint mode [2.5] is as follows:

- In **Fixed** LWT setpoint mode, the LWT schedules need to be selected. For more details, see "[\[2.3\] Heating schedule](#)" [▶ 87].

**Note:** When **Fixed** setpoint mode is selected, the shift schedules are available, but will NOT have any effect.

- In **Weather dependent** LWT setpoint mode, the shift schedules need to be selected. For more details, see "[\[2.18\] Leaving water shift heating schedule](#)" [▶ 94].

**Note:** When **Weather dependent** setpoint mode is selected, the fixed schedules are available but will NOT have any effect.

### [2.3] Heating schedule

⚙️[N/A]	<p><b>Restriction:</b> Only applicable if [1.12] = <b>Leaving water</b>.</p> <p>Schedule for the additional zone in heating mode to set the desired leaving water temperature.</p>
<p><b>Predefined schedules:</b> 3</p> <p><b>Activation screen:</b> [2.2] <b>Heating schedule enable</b></p> <p><b>Possible actions:</b> Leaving water temperatures within range.</p> <p><b>Note:</b> In case of LWT scheduling, operation will be OFF when no temperature is scheduled.</p>	

### [2.4] Cooling schedule

⚙️[N/A]	<p><b>Restriction:</b> Only applicable if [1.12] = <b>Leaving water</b>.</p> <p>Schedule for the additional zone in cooling mode to set the desired leaving water temperature.</p>
<p><b>Predefined schedules:</b> 1</p> <p><b>Activation screen:</b> [2.27] <b>Cooling schedule enable</b></p> <p><b>Possible actions:</b> Leaving water temperatures within range.</p> <p><b>Note:</b> In case of LWT scheduling, operation will be OFF when no temperature is scheduled.</p>	

### [2.5] Heating setpoint mode

⚙️[N/A]	<p>Defines the setpoint mode for the additional zone in space heating operation, which can be set independently from the setpoint mode for the main zone.</p>
<ul style="list-style-type: none"> <li>▪ 0: <b>Fixed:</b> The desired leaving water temperature does NOT depend on the outdoor ambient temperature.</li> <li>▪ 1: <b>Weather dependent:</b> The desired leaving water temperature depends on the outdoor ambient temperature.</li> </ul>	

When weather-dependent operation is active, low outdoor temperatures will result in warmer water and vice versa. During weather-dependent operation, the user can shift the water temperature up or down by a maximum of 10°C. For more details, see "[\[2.22\] Leaving water shift heating](#)" [▶ 96].

## [2.6] Setpoint range: Heating / [2.37] Setpoint range: Cooling

**[2.6] Setpoint range: Heating**

To prevent wrong too hot temperatures, you can limit the range of desired leaving water temperatures that users can set for the additional zone in heating mode.	
⚙️[060]	<b>Heating maximum<sup>(a)</sup>:</b> <ul style="list-style-type: none"> <li>▪ If [2.11] = Radiator: [061]°C~75°C</li> <li>▪ Else: [061]°C~55°C</li> </ul>
⚙️[061]	<b>Heating minimum:</b> <ul style="list-style-type: none"> <li>▪ 20°C~[060]°C</li> </ul>

<sup>(a)</sup> For more details, see "[3.12] Overheating setpoint" [▶ 104] and the field settings table of the installer reference guide.

**NOTICE****Overheating limit**

- Heat sources can be switched OFF when the maximum space heating setpoint (⚙️ [053] main zone, ⚙️[060] additional zone) is lower than: defrost cutout (35°C) + max delta T (a) + 2°C overshoot.
- In some cases, during a failed emitter defrost, this target temperature offset can be increased by an additional 5°C to increase the success rate after the failed defrost.

**NOTICE**

The maximum setpoint range depends on the emitter type when a mixing kit or a bizon unit is connected. For more details, see configuration reference guide [1.11] **Emitter type**.

The minimum leaving water target for the heat pump and the backup heater is determined by the minimum water temperature required to initiate defrost. Even if a lower setpoint is selected, the minimum active setpoint will always be the defrost start temperature + the maximum target delta T + 1°C.

The maximum delta T is defined by the delta T of the main zone and the additional zone (see configuration reference guide [1.14] **Delta T heating** and [2.14] **Delta T heating**).

The values in the below graph are examples. For the details about the minimum required water temperature to start defrost, go to <https://daikintechnicaldatahub.eu/> to see the actual operation range drawing.

**Heating mode operation limits****1. Zone (d):**

- **Conditions:** When a setpoint is selected in this zone (d).
- **Result:** The backup heater target temperature is pushed to the blue line (c) + 1°C (= defrost line + target delta T (b) + 1°C) and the heat pump is NOT allowed to operate.

**2. Zone (e):**

- **Conditions:** When a setpoint is selected in this zone (e).
- **Result:** The heat pump is forced off and the backup heater becomes the only active heat source for space heating towards the selected setpoint.

**3. Zone (f):**

- **Conditions:** When a setpoint is selected in this zone (f)
- **Result:** The heat pump and backup heater target temperature are pushed to the blue line (c) + 1°C (= defrost line + maximum target delta T (a) + 1°C) and the heat pump is allowed to operate when the entering temperature is above the "minimum heat pump start-up limit" line.

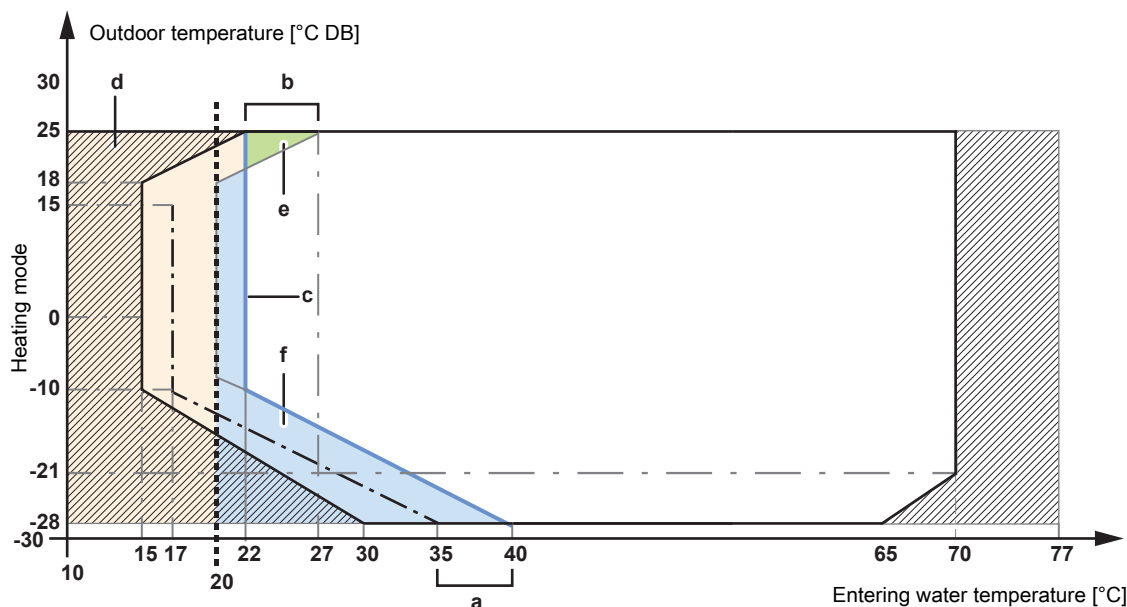

- Minimum heat pump start-up limit
- · - Minimum water temperature to start defrost
- - - Minimum setpoint 20°C
- ▨ Backup heater only operation
- a** Maximum target delta T
- b** Maximum target delta T
- c** Defrost line + target delta T
- d~f** Zone



**NOTICE**

In case of a floor heating application it is important to limit the maximum leaving water temperature at heating operation according to the specifications of the floor heating installation.



**NOTICE**

- When adjusting the leaving water temperature ranges, all desired leaving water temperatures are also adjusted to guarantee they are between the limits.
- Always balance between the desired leaving water temperature with the desired room temperature and/or the capacity (according to the design and selection of the heat emitters). The desired leaving water temperature is the result of several settings (preset values, shift values, weather-dependent curves, modulation). As a result, too high or too low leaving water temperatures could occur which lead to overtemperatures or capacity shortage. By limiting the leaving water temperature range to adequate values (depending on the heat emitter), such situations can be avoided.

**[2.37] Setpoint range: Cooling**

To prevent wrong too cold temperatures, you can limit the range of desired leaving water temperatures that users can set for the additional zone in cooling mode.

⚙️[062]	<b>Cooling maximum:</b> ▪ [063]°C~22°C
⚙️[063]	<b>Cooling minimum<sup>(a)</sup>:</b> ▪ 7°C~[062]°C

<sup>(a)</sup> For more details, see " [3.11] Undercooling setpoint" ▶ 103] and the field settings table of the installer reference guide.



**NOTICE**

In case of a floor heating application it is important to limit the minimum leaving water temperature at cooling operation to 18~20°C to prevent condensation on the floor.



**NOTICE**

- When adjusting the leaving water temperature ranges, all desired leaving water temperatures are also adjusted to guarantee they are between the limits.
- Always balance between the desired leaving water temperature with the desired room temperature and/or the capacity (according to the design and selection of the heat emitters). The desired leaving water temperature is the result of several settings (preset values, shift values, weather-dependent curves, modulation). As a result, too high or too low leaving water temperatures could occur which lead to overtemperatures or capacity shortage. By limiting the leaving water temperature range to adequate values (depending on the heat emitter), such situations can be avoided.

[2.7] Cooling setpoint mode

⚙️[N/A]	Defines the setpoint mode for the additional zone in space cooling operation, which can be set independently from the setpoint mode for the main zone.
	<ul style="list-style-type: none"> <li>▪ 0: <b>Fixed</b>: The desired leaving water temperature does NOT depend on the outdoor ambient temperature.</li> <li>▪ 1: <b>Weather dependent</b>: The desired leaving water temperature depends on the outdoor ambient temperature.</li> </ul>

When weather-dependent operation is active, low outdoor temperatures will result in warmer water and vice versa. During weather-dependent operation, the user can shift the water temperature up or down by a maximum of 10°C. For more details, see "[2.23] Leaving water shift cooling" [▶ 96].

[2.8] Heating WD curve

⚙️[N/A]	Defines the weather-dependent curve used to determine the leaving water temperature of the additional zone in space heating operation.  <b>Restriction:</b> The curve is only used when [2.5] = <b>Weather dependent</b> .
	See " <a href="#">4 Weather-dependent curve</a> " [▶ 26].

The weather-dependent heating can be configured according to the figure below.

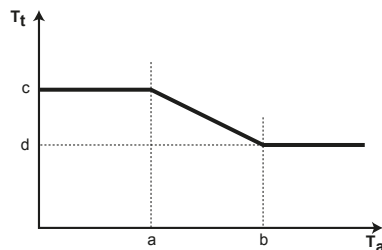

- T<sub>t</sub> Target leaving water temperature (additional zone)
- T<sub>a</sub> Outdoor temperature
- a Low outdoor ambient temperature. -40°C~+5°C
- b High outdoor ambient temperature. 5°C~25°C

- c** Desired leaving water temperature when the outdoor temperature equals or drops below the low ambient temperature. [061]°C~[060]°C  
**Note:** This value should be higher than (d) as for low outdoor temperatures warmer water is required.
- d** Desired leaving water temperature when the outdoor temperature equals or rises above the high ambient temperature. [061]°C~[060]°C  
**Note:** This value should be lower than (c) as for high outdoor temperatures less warm water is required.

## [2.9] Cooling WD curve

⚙️[N/A]	Defines the weather-dependent curve used to determine the leaving water temperature of the additional zone in space cooling operation. <b>Restriction:</b> The curve is only used when [2.7] = <b>Weather dependent</b> .
See " <a href="#">4 Weather-dependent curve</a> " [▶ 26].	

The weather-dependent cooling can be configured according to the figure below.

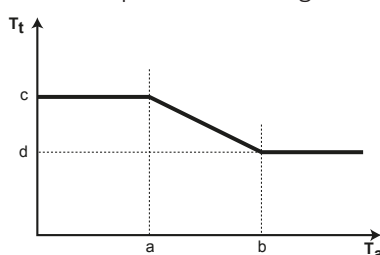

- T<sub>t</sub>** Target leaving water temperature (additional zone)
- T<sub>a</sub>** Outdoor temperature
- a** Low outdoor ambient temperature. 10°C~25°C
- b** High outdoor ambient temperature. 25°C~43°C
- c** Desired leaving water temperature when the outdoor temperature equals or drops below the low ambient temperature. [063]°C~[062]°C  
**Note:** This value should be higher than (d) as for low outdoor temperatures less cold water is required.
- d** Desired leaving water temperature when the outdoor temperature equals or rises above the high ambient temperature. [063]°C~[062]°C

## [2.10] NOT USED

## [2.11] Emitter type

⚙️[N/A]	Must match your system layout. Emitter type of the additional zone.
<ul style="list-style-type: none"> <li>▪ 0: Under floor heating</li> <li>▪ 1: Heat pump convector</li> <li>▪ 2: Radiator</li> </ul>	

The setting **Emitter type** influences the space heating setpoint range and the target delta T in heating as follows:

Emitter type Main zone	Space heating setpoint range [060]~[061] <sup>(a)</sup>	Target delta T in heating
0: Under floor heating	Maximum 55°C	3°C~10°C (see " <a href="#">2.14 Delta T heating</a> " [▶ 93])
1: Heat pump convector	Maximum 55°C	3°C~10°C (see " <a href="#">2.14 Delta T heating</a> " [▶ 93])

Emitter type Main zone	Space heating setpoint range [060]~[061] <sup>(a)</sup>	Target delta T in heating
2: Radiator	Maximum 75°C	10°C~20°C (see " [2.14] Delta T heating" [▶ 93])

<sup>(a)</sup> This column only explains the maximum setpoint range. For more details about the setpoint range, see " [2.6] Setpoint range: Heating / [2.37] Setpoint range: Cooling" [▶ 88].

**Remark:** When changing the emitter type from **Under floor heating** or **Heat pump convector** to **Radiator**, the maximum setpoint range will NOT automatically adapt to 75°C. If required, it needs to be manually increased again.

## [2.12] Control

⚙️[057]	Shows (read-only) the unit control method for the additional zone.
<p>This setting is determined by the unit control method for the main zone (see " [1.12] Control" [▶ 74]):</p> <ul style="list-style-type: none"> <li>▪ 0: <b>Leaving water</b> if the unit control method for the main zone selected in [1.12] is <b>Leaving water</b>.</li> <li>▪ 1: <b>External room thermostat</b> if the unit control method for the main zone selected in [1.12] is: <ul style="list-style-type: none"> <li>- External room thermostat, or</li> <li>- Room</li> </ul> </li> </ul> <p>In case of external room thermostat control, you must also set the external room thermostat type with setting [2.13] (see " [2.13] External room thermostat" [▶ 92]).</p>	

## [2.13] External room thermostat

**Note:** To be used in combination with [2.12] = **External room thermostat**.

**NOTICE**

**External room thermostat requests.** You can define the external room thermostat requests in different ways:

**1. Via hardware:**

- Install an external room thermostat.
- Go to **External room thermostat** ([1.13] for main zone or [2.13] for additional zone).
- Set **Input source** = **Hardware**.
- In the selection box **Connection type**, select which external room thermostat type you used (**Single contact** or **Dual contact**).

**2. Via Modbus:**

- Go to **External room thermostat** ([1.13] for main zone or [2.13] for additional zone).
- Set **Input source** = **External**.
- Main zone: Use holding register 74: Thermostat request Main.
- Additional zone: Use holding register 75: Thermostat request Add.

**3. Via Cloud:** Momentarily, only available for business-to-business integrators. For more information, see <https://developer.cloud.daikinurope.com>.

- Go to **External room thermostat** ([1.13] for main zone or [2.13] for additional zone).
- Set **Input source** = **External**.
- Use the ONECTA cloud API to adjust the external room thermostat requests.

**Input source**

⚙️[181]	Must match your system layout. Input source of the external room thermostat for the additional zone.
<ul style="list-style-type: none"> <li>▪ 0: <b>Hardware</b>: For external room thermostat connected to the unit.</li> <li>▪ 1: <b>External</b>: For Cloud and Modbus.</li> </ul>	

**Connection type**

⚙️[146]	<p><b>Restriction:</b> Only applicable if [2.13] <b>Input source</b> = <b>Hardware</b>.</p> <p>Must match your system layout. External room thermostat type for the additional zone.</p>
<ul style="list-style-type: none"> <li>▪ 1: <b>Single contact</b>: The used external room thermostat can only send a thermo ON/OFF condition. There is no separation between heating or cooling demand. Select this value in case of a connection to the heat pump convector (FWX*).</li> <li>▪ 0: <b>Dual contact</b>: The used external room thermostat can send a separate heating/cooling thermo ON/OFF condition. Select this value in case of connection to multi-zoning wired controls, wired room thermostats (EKRTWA) or wireless room thermostats (EKRTTB).</li> </ul>	

**[2.14] Delta T heating**

Delta T target for the additional zone during space heating operation.

A minimum temperature difference is required for proper operation of heat emitters in heating mode.

⚙️[171]	▪ If [2.11] = <b>Under floor heating</b> or <b>Heat pump convector</b> , the range is 3°C~10°C.
⚙️[172]	▪ If [2.11] = <b>Radiator</b> , the range is 10°C~20°C.

For more information about **Delta T heating**, see "[\[1.14\] Delta T heating](#)" [▶ 75].

[2.15] **Enable zone**

⚙️[N/A]	<p><b>Restriction:</b> Only applicable if [1.12] = <b>Leaving water</b>.</p> <p>Turns ON/OFF the additional zone and allows space heating operation.</p>
<ul style="list-style-type: none"> <li>▪ OFF (disabled)</li> <li>▪ ON (enabled)</li> </ul>	

[2.16] NOT USED

[2.17] **Delta T cooling**

⚙️[148]	<p>Delta T target for the additional zone during space cooling operation.</p> <p>A minimum temperature difference is required for proper operation of heat emitters in cooling mode.</p>
<ul style="list-style-type: none"> <li>▪ 3°C~10°C</li> </ul>	

For more information about **Delta T cooling**, see "[\[1.18\] Delta T cooling](#)" [▶ 77].

[2.18] **Leaving water shift heating schedule**

⚙️[N/A]	<p><b>Restriction:</b> Only applicable if:</p> <ul style="list-style-type: none"> <li>▪ [1.12] = <b>Leaving water</b>, and</li> <li>▪ [2.5] = <b>Weather dependent</b>.</li> </ul> <p>Schedule of the leaving water temperature target shift on the weather-dependent curve during space heating operation in the additional zone.</p>
<ul style="list-style-type: none"> <li>▪ <b>Predefined schedules:</b> 3</li> <li>▪ <b>Activation:</b> [2.31] <b>Scheduled WD LWT shift for heating</b></li> <li>▪ <b>Possible actions:</b> Leaving water shift temperatures on the weather-dependent curve.</li> </ul> <p><b>Note:</b> Only in case weather-dependent curve is used (see "<a href="#">4 Weather-dependent curve</a>" [▶ 26]).</p> <ul style="list-style-type: none"> <li>▪ You can schedule 10 actions per day.</li> </ul>	

This setting enables to apply a temperature shift for a certain time during space heating operation in the additional zone. Its value will increase or decrease the value of the weather-dependent curve according to a value selected in a schedule.

**Example:**

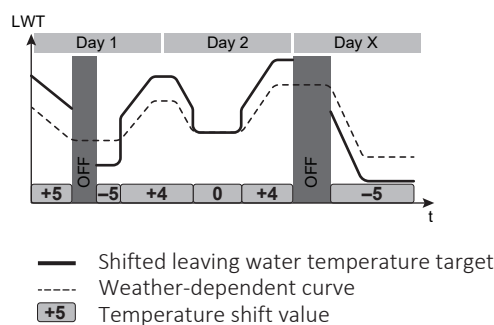

**Remark:** In case of LWT shift scheduling, there will be **NO operation** at times when no temperature shift is scheduled.

### [2.19] Leaving water shift cooling schedule

⚙️[N/A]	<p><b>Restriction:</b> Only applicable if:</p> <ul style="list-style-type: none"> <li>▪ [1.12] = Leaving water, and</li> <li>▪ [2.7] = Weather dependent.</li> </ul> <p>Schedule of the leaving water temperature target shift on the weather-dependent curve during space cooling operation in the additional zone.</p>
	<ul style="list-style-type: none"> <li>▪ <b>Predefined schedules:</b> 1</li> <li>▪ <b>Activation:</b> [2.32] Scheduled WD LWT shift for cooling</li> <li>▪ <b>Possible actions:</b> Leaving water shift temperatures on the weather-dependent curve.</li> </ul> <p><b>Note:</b> Only in case weather-dependent curve is used (see "<a href="#">4 Weather-dependent curve</a>" [▶ 26]).</p> <ul style="list-style-type: none"> <li>▪ You can schedule 10 actions per day.</li> </ul>

This setting enables to apply a temperature shift for a certain time during space cooling operation in the additional zone. Its value will increase or decrease the value of the weather-dependent curve according to a value selected in a schedule.

#### Example:

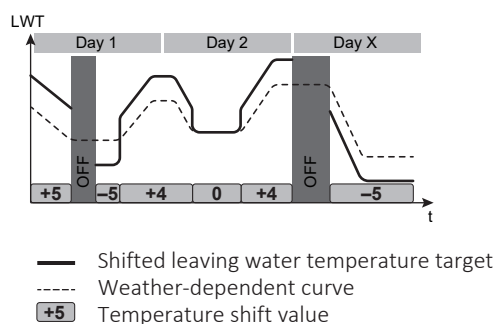

**Remark:** In case of LWT shift scheduling, there will be **NO operation** at times when no temperature shift is scheduled.

[2.20] Increase around 0°C

<p>⚙️[059]</p>	<p>For additional zone.</p> <p>Use this setting to compensate for possible heat losses of the building due to the evaporation of melted ice or snow. (e.g. in cold region countries). In heating operation, the desired leaving water temperature is locally increased around an outdoor temperature of 0°C. This compensation can be selected when using an absolute or a weather-dependent desired temperature (see illustration below).</p> <div style="text-align: center;"> </div> <p><b>a:</b> Absolute desired leaving water temperature  <b>b:</b> Weather-dependent desired leaving water temperature  <b>L:</b> Increase; <b>R:</b> Span; <b>X:</b> Outdoor temperature; <b>Y:</b> Leaving water temperature</p>
<ul style="list-style-type: none"> <li>▪ 0: No</li> <li>▪ 1: increase 2°C, span 4°C</li> <li>▪ 2: increase 2°C, span 8°C</li> <li>▪ 3: increase 4°C, span 4°C</li> <li>▪ 4: increase 4°C, span 8°C</li> </ul>	

[2.21] Zone name

<p>⚙️[N/A]</p>	<p>Use this setting to change the name of the additional zone.</p>
<ul style="list-style-type: none"> <li>▪ The zone name is limited to 16 characters.</li> </ul>	

[2.22] Leaving water shift heating

<p>⚙️[N/A]</p>	<p><b>Restriction:</b> Only applicable if [2.5] = <b>Weather dependent</b>.</p> <p>The shift of the selected setpoint to the weather-dependent curve for the leaving water temperature of the additional zone in heating operation.</p>
<ul style="list-style-type: none"> <li>▪ -10°C~10°C</li> </ul> <p><b>Remark:</b> This setting can overrule [2.18] <b>Leaving water shift heating schedule</b> until the next scheduled shift trigger occurs.</p>	

[2.23] Leaving water shift cooling

<p>⚙️[N/A]</p>	<p><b>Restriction:</b> Only applicable if [2.7] = <b>Weather dependent</b>.</p> <p>The shift of the selected setpoint to the weather-dependent curve for the leaving water temperature of the additional zone in cooling operation.</p>
<ul style="list-style-type: none"> <li>▪ -10°C~10°C</li> </ul> <p><b>Remark:</b> This setting can overrule [2.19] <b>Leaving water shift cooling schedule</b> until the next scheduled shift trigger occurs.</p>	

[2.24] NOT USED

[2.25] NOT USED

[2.26] NOT USED

## [2.27] Cooling schedule enable

⚙️[N/A]	<p><b>Restriction:</b> Only applicable if [1.12] = <b>Leaving water</b>. Activation screen for [2.4] <b>Cooling schedule</b>.</p>
<p>The influence of the LWT setpoint mode [2.7] is as follows:</p> <ul style="list-style-type: none"> <li>▪ In <b>Fixed</b> LWT setpoint mode, the LWT schedules need to be selected. For more details, see " [2.4] <b>Cooling schedule</b>" [▶ 87].</li> </ul> <p><b>Note:</b> When <b>Fixed</b> setpoint mode is selected, the shift schedules are available, but will NOT have any effect.</p> <ul style="list-style-type: none"> <li>▪ In <b>Weather dependent</b> LWT setpoint mode, the shift schedules need to be selected. For more details, see " [2.19] <b>Leaving water shift cooling schedule</b>" [▶ 95].</li> </ul> <p><b>Note:</b> When <b>Weather dependent</b> setpoint mode is selected, the fixed schedules are available but will NOT have any effect.</p>	

[2.28] NOT USED

[2.29] NOT USED

## [2.30] Leaving water temp. heating

⚙️[N/A]	<p>Setpoint for the desired leaving water temperature during space heating of the additional zone.</p> <p><b>Note:</b> In case of weather-dependent mode, LWT is not controlled by this setting.</p>
[061]°C~[060]°C	

## [2.31] Scheduled WD LWT shift for heating

⚙️[N/A]	<p><b>Restriction:</b> Only applicable if:</p> <ul style="list-style-type: none"> <li>▪ [1.12] = <b>Leaving water</b>, and</li> <li>▪ [2.5] = <b>Weather dependent</b>.</li> </ul> <p>Activation screen for [2.18] <b>Leaving water shift heating schedule</b> (see " [2.18] <b>Leaving water shift heating schedule</b>" [▶ 94]). Enables/disables a temperature shift on the weather-dependent leaving water target during space heating operation in the additional zone.</p>
<ul style="list-style-type: none"> <li>▪ ON (enabled)</li> <li>▪ OFF (disabled)</li> </ul> <p><b>Note:</b> When the weather-dependent setpoint mode is active, the fixed schedules remain selectable, but will NOT have any effect. The leaving water temperature is then NOT controlled by the setting [2.30] <b>Leaving water temp. heating</b>.</p>	

## [2.32] Scheduled WD LWT shift for cooling

⚙️[N/A]	<p><b>Restriction:</b> Only applicable if:</p> <ul style="list-style-type: none"> <li>▪ [1.12] = <b>Leaving water</b>, and</li> <li>▪ [2.7] = <b>Weather dependent</b>.</li> </ul> <p>Activation screen for [2.19] <b>Leaving water shift cooling schedule</b> (see "<a href="#">[2.19] Leaving water shift cooling schedule</a>" [▶ 95]). Enables/disables a temperature shift on the weather-dependent leaving water target during space cooling operation in the additional zone.</p>
<ul style="list-style-type: none"> <li>▪ ON (enabled)</li> <li>▪ OFF (disabled)</li> </ul> <p><b>Note:</b> When the weather-dependent setpoint mode is active, the fixed schedules remain selectable, but will NOT have any effect. The leaving water temperature is then NOT controlled by the setting [2.36] <b>Leaving water temp. cooling</b>.</p>	

## [2.33] Cooling allowance

⚙️[147]	Allows/disallows cooling operation in the additional zone.
<ul style="list-style-type: none"> <li>▪ 0: No (disallowed): The cooling request for the additional zone will be ignored. <ul style="list-style-type: none"> <li>- If a shut-off valve is connected to the additional zone, it will close.</li> <li>- If an external pump is connected to the additional zone, it will be switched OFF during cooling operation preventing cold water from entering the additional zone.</li> </ul> </li> <li>▪ 1: Yes (allowed): The cooling request for the additional zone is NOT influenced. <ul style="list-style-type: none"> <li>- If a shut-off valve is connected to the additional zone, it will remain open.</li> <li>- If an external pump is connected to the additional zone, it will remain operational during cooling operation.</li> </ul> </li> </ul>	

For more details, see "[\[1.16\] Cooling allowance](#)" [▶ 76].

[2.34] NOT USED

[2.35] NOT USED

## [2.36] Leaving water temp. cooling

⚙️[N/A]	<p>Setpoint for the desired leaving water temperature during space cooling of the additional zone.</p> <p><b>Note:</b> In case of weather-dependent mode, LWT is not controlled by this setting.</p>
[063]°C~[062]°C	

## [2.37] Setpoint range: Cooling

See "[\[2.6\] Setpoint range: Heating](#) / [\[2.37\] Setpoint range: Cooling](#)" [▶ 88]

## [3] Heating/cooling

In this chapter

[3.1] Operation allowance: Heating / [3.16] Operation allowance: Cooling.....	99
[3.2] Operation mode.....	99
[3.3] NOT USED .....	101
[3.4] Antifrost .....	101
[3.5] Operation mode schedule.....	101
[3.6] Additional zone.....	101
[3.7] Max. heating overshoot LWT .....	102
[3.8] Averaging time.....	103
[3.9] Max. cooling undershoot LWT.....	103
[3.10] NOT USED .....	103
[3.11] Undercooling setpoint.....	103
[3.12] Overheating setpoint .....	104
[3.13] Bizone kit.....	104
[3.14] Room thermostat present.....	106
[3.15] Heatpump minimum on time.....	106
[3.16] Operation allowance: Cooling .....	106

### [3.1] Operation allowance: Heating / [3.16] Operation allowance: Cooling

#### [3.1] Operation allowance: Heating

⚙️[N/A]	<p>Defines the average outdoor temperature above which the operation of the unit in space heating is prohibited.</p> <p>These settings are also used in automatic heating/cooling changeover.</p>
<ul style="list-style-type: none"> <li>▪ <b>Space heating:</b> When the averaged outdoor temperature rises above this value, space heating is turned OFF. 14~35°C</li> <li>▪ Confirm with the ✓ button.</li> </ul>	

#### [3.16] Operation allowance: Cooling

⚙️[N/A]	<p>Defines the average outdoor temperature below which the operation of the unit in space cooling is prohibited.</p> <p>These settings are also used in automatic heating/cooling changeover.</p>
<ul style="list-style-type: none"> <li>▪ <b>Space cooling:</b> When the averaged outdoor temperature drops below this value, space cooling is turned OFF. 10~35°C</li> <li>▪ Confirm with the ✓ button.</li> </ul>	

### [3.2] Operation mode

⚙️[N/A]	<p>Sets the space operation mode.</p>
<ul style="list-style-type: none"> <li>▪ Heating</li> <li>▪ Cooling</li> <li>▪ Automatic</li> </ul> <p>See below for how to use these settings.</p>	

#### About space operation modes

Your unit is a heating/cooling model, it can both heat up and cool down a space. You have to tell the system which operation mode to use. There are two possibilities to do so:

If	Then
<p><b>Possibility 1:</b> In case:</p> <ul style="list-style-type: none"> <li>▪ There is only one zone (main zone)</li> <li>▪ And the main zone is controlled by an external room thermostat</li> <li>▪ And individual heating/cooling requests are sent to the unit in one of the following ways: <ul style="list-style-type: none"> <li>- Via hardware (external room thermostats with dual contacts).</li> <li>- Via external communication input, like Modbus or Cloud.</li> </ul> </li> </ul>	<p>Operation mode is decided by the external room thermostat</p>
<p><b>Possibility 2:</b> In other cases than possibility 1.</p>	<p>Operation mode is decided by settings:</p> <p>[3.2] <b>Operation mode</b>, [3.5] <b>Operation mode schedule</b> (and [3.1] <b>Operation allowance: Heating</b>, [3.16] <b>Operation allowance: Cooling</b>)</p>

#### To check which space operation mode is currently used

The space operation mode is displayed on the home screen:

- When the unit is in heating mode, the ☀ icon is shown.
- When the unit is in cooling mode, the ❄ icon is shown.

The status indicator shows if the unit is currently in operation:

- When the unit is not in operation, the status indicator will show a blue pulsation with an interval of approximately 5 seconds.
- While the unit is in operation, the status indicator will light up blue constantly.

#### To set the space operation mode

Using settings [3.2], [3.5] (and [3.1], [3.16]):

<b>1</b>	<p>Go to [3.2]: <b>Heating/cooling &gt; Operation mode</b>.</p> <p><b>Note:</b> Tap on the <b>Spaces</b> bar from the home screen for a quick access screen where the <b>Operation mode</b> can be selected. When <b>Automatic</b> is selected, there is a button that links to [3.5] <b>Operation mode schedule</b>.</p>
<b>2</b>	<p>Select one of the following options:</p> <ul style="list-style-type: none"> <li>▪ <b>Heating:</b> <b>Result:</b> The operation mode is <b>permanently heating</b>. This procedure is finished.</li> <li>▪ <b>Cooling:</b> <b>Result:</b> The operation mode is <b>permanently cooling</b>. This procedure is finished.</li> <li>▪ <b>Automatic:</b> <b>Result:</b> The automatic operation mode depends on a <b>monthly schedule</b>. Go to the next step.</li> </ul>
<b>3</b>	<p>Go to [3.5]: <b>Heating/cooling &gt; Operation mode schedule</b>.</p>

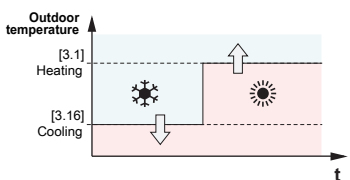
<b>4</b>	Select a month.
<b>5</b>	For each month, select one of the following options: <ul style="list-style-type: none"> <li>▪ Heating</li> <li>▪ Cooling</li> <li>▪ Automatic</li> </ul>
<b>5a</b>	<b>Heating:</b> Use this during cold season (e.g. October, November, December January, February and March). <b>Result:</b> For the selected month, only heating is possible.
<b>5b</b>	<b>Cooling:</b> Use this during warm season (e.g. June, July and August). <b>Result:</b> For the selected month, only cooling is possible.
<b>5c</b>	<b>Automatic:</b> Use this between cold and warm season (e.g. April, May and September). <b>Result:</b> For the selected month, the unit automatically switches between heating and cooling. The changeover depends on: <ul style="list-style-type: none"> <li>▪ The outdoor temperature</li> <li>▪ The setpoints defined in [3.1] <b>Operation allowance: Heating</b> and [3.16] <b>Operation allowance: Cooling</b>. The difference between the two setpoints is used like a hysteresis in order to avoid frequent changeover.</li> </ul>  <p><b>Note:</b> If changeover occurs too frequent due to direct sunlight on the outdoor unit, the remote outdoor sensor (EKRSKA1) can be installed to improve the system behaviour.</p>
<b>6</b>	Confirm the changes.

[3.3] NOT USED

### [3.4] Antifrost

⚙️[N/A]	Enables/disables the room antifrost functionality.
	<ul style="list-style-type: none"> <li>▪ OFF (disabled)</li> <li>▪ ON (enabled)</li> </ul>

For more details, see " [1.22] Antifrost" [▶ 78].

### [3.5] Operation mode schedule

See " [3.2] Operation mode" [▶ 99].

### [3.6] Additional zone

⚙️[155]	Must match your system layout. Indicates whether an additional zone is present.
---------	--

- 0: OFF (not present). There is only one leaving water temperature zone.
- 1: ON (present). There are two leaving water temperature zones. In heating, the main leaving water temperature zone consists of the lowest temperature heat emitters and a mixing station to achieve the desired leaving water temperature.



**INFORMATION**

**Mixing station.** If your system layout contains 2 LWT zones, you can install a mixing station in front of the main LWT zone. However, other dual zone applications with shut-off valves are also possible. For more information, see the application guidelines in the installer reference guide.



**NOTICE**

NOT configuring the system in the following way can cause damage to the heat emitters. If there are 2 zones, it is important that in heating:

- the zone with the lowest water temperature is configured as the main zone, and
- the zone with the highest water temperature is configured as the additional zone.



**NOTICE**

If there are 2 zones and the emitter types are wrongly configured, water of high temperature can be sent towards a low temperature emitter (underfloor heating). To avoid this:

- Install an aquastat/thermostatic valve to avoid too high temperatures towards a low temperature emitter.
- Make sure you set the emitter types for the main zone and for the additional zone correctly in accordance with the connected emitter.

[3.7] Max. heating overshoot LWT

<p>⚙️[017] / [018]</p>	<p><b>Restriction:</b> This function is only applicable in heating mode.</p> <p>This function defines how much the water temperature may rise above the desired leaving water temperature before the compressor stops. A higher value will result in less start/stop cycles of the heat pump, but could also lead to lesser comfort. The opposite is valid if a lower value is chosen.</p> <p>The compressor will start up again when the leaving water temperature drops below the desired leaving water temperature.</p> <p><b>Note:</b> The selection in [3.7] will depend on the selected emitter type (see below).</p>
<p>⚙️[017]</p>	<p>Used to calculate the maximum overshoot on the leaving water temperature during space heating for <b>underfloor heating</b>.</p> <ul style="list-style-type: none"> <li>▪ 1~7°C</li> </ul>
<p>⚙️[018]</p>	<p>Used to calculate the maximum overshoot on the leaving water temperature during space heating for <b>radiators or heat pump convectors</b>.</p> <ul style="list-style-type: none"> <li>▪ 1~10°C</li> </ul>

## [3.8] Averaging time

⚙️[007]	<p>The outdoor temperature is averaged over the selected time period.</p> <p>The average timer corrects the influence of ambient temperature variations.</p> <p>The averaged outdoor temperature will be used by the following functionalities:</p> <ul style="list-style-type: none"> <li>▪ weather-dependent curve,</li> <li>▪ <b>Operation allowance</b> based on ambient temperature,</li> <li>▪ during changeover, if <b>Scheduled</b> and <b>Automatic</b> operation modes are active,</li> <li>▪ <b>Increase around 0°C.</b></li> </ul>
	<ul style="list-style-type: none"> <li>▪ 0: No averaging</li> <li>▪ 1: 12 hours</li> <li>▪ 2: 24 hours</li> <li>▪ 3: 48 hours</li> <li>▪ 4: 72 hours</li> </ul>

## [3.9] Max. cooling undershoot LWT

⚙️[004]	<p><b>Restriction:</b> This function is only applicable in cooling mode.</p> <p>This function defines how much the water temperature may drop below the desired leaving water temperature before the compressor stops. The compressor will start up again when the leaving water temperature rises above the desired leaving water temperature.</p>
	0~10°C

## [3.10] NOT USED

## [3.11] Undercooling setpoint

⚙️[014]	<p>This limit prevents too low water temperatures from entering the emitter system. When this limit is reached, the heat pump and the pump will be switched OFF and cold water can no longer enter the emitter circuit.</p> <p>See "INFORMATION" below.</p>
	3~35°C

**INFORMATION**

The minimum leaving water temperature is decided based on setting [3.11] **Undercooling setpoint**. This limit defines the minimum leaving water **in the system**. Depending on the value of this setting, the minimum LWT setpoint will also be increased by 4°C to allow stable control towards the setpoint.

The minimum leaving water temperature **in the main zone** is decided based on setting [1.20] **Undercooling water circuit**, only in case [3.13.5] **Bizone kit installed** is enabled. This limit defines the minimum leaving water **in the main zone**. Depending on the value of this setting, the minimum LWT setpoint will also be increased by 4°C to allow stable control towards the setpoint.

## [3.12] Overheating setpoint

⚙️[015]	This limit prevents too high water temperatures from entering the emitter system. When this limit is reached, the heat sources and the pump will be switched OFF and hot water can no longer enter the emitter circuit. See "INFORMATION" below.
20~80°C	

**INFORMATION**

The maximum leaving water temperature is decided based on setting [3.12] **Overheating setpoint**. This limit defines the maximum leaving water **in the system**. Depending on the value of this setting, the maximum LWT setpoint will also be reduced by 5°C to allow stable control towards the setpoint.

The maximum leaving water temperature **in the main zone** is decided based on setting [1.19] **Overheating water circuit**, only in case [3.13.5] **Bizone kit installed** is enabled. This limit defines the maximum leaving water **in the main zone**. Depending on the value of this setting, the maximum LWT setpoint will also be reduced by 5°C to allow stable control towards the setpoint.

## [3.13] Bizone kit

For more details about the correct setting selection, see the application guidelines chapter of the installer reference guide.

Additionally to the settings listed below, make sure to also set [3.6] **Additional zone** = ON (present) when a bizone kit is installed.

**[3.13.1] Bizone system type**

⚙️[008]	Must match your system layout. Indicates whether a decoupling vessel is present in the hydraulic system.
---------	---

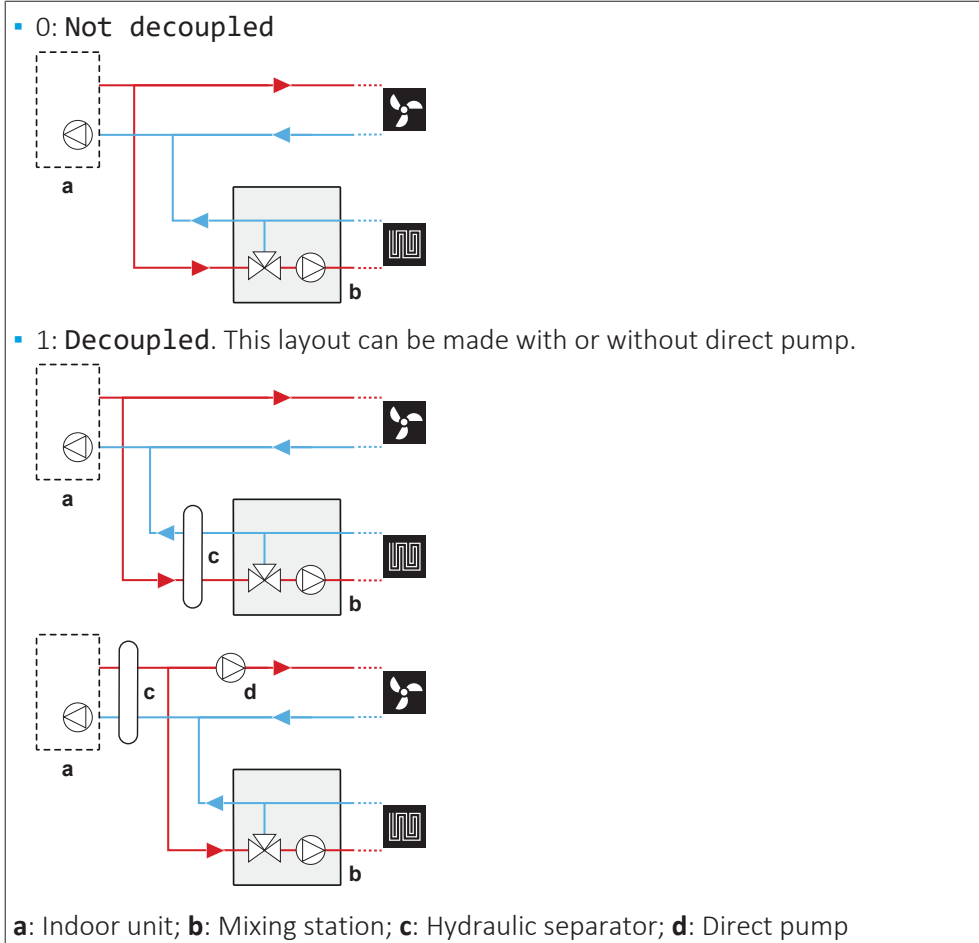

### [3.13.2] Add zone pump fixed PWM

⚙️[097]	Fixed pump speed for additional (direct) zone.
<ul style="list-style-type: none"> <li>▪ If set via breadcrumb: 0~100%</li> <li>▪ If set via field code: 0~1 (step: 0.01)</li> </ul>	

### [3.13.3] Main zone pump fixed PWM

⚙️[096]	Fixed pump speed for main (mixed) zone.
<ul style="list-style-type: none"> <li>▪ If set via breadcrumb: 0~100%</li> <li>▪ If set via field code: 0~1 (step: 0.01)</li> </ul>	

### [3.13.4] Mixing valve turning time

⚙️[176]	Time in seconds for the mixing valve to turn from one side to the other. If a third-party mixing valve is installed in combination with controller EKMIKPOA, the valve turning time must be set accordingly.
20~300 seconds	

### [3.13.5] Bizone kit installed

⚙️[099]	Must match your system layout. Indicates whether a mixing kit is installed in the hydraulic system.
---------	--

- 0: OFF (not installed)
- 1: ON (installed)

**Remark:** When connecting and reconnecting the mixing kit, a power reset might be required if the bizona kit is not automatically detected.

### [3.14] Room thermostat present

This is the same setting as "[\[1.31\] Daikin room thermostat](#)" [[▶ 82](#)].

### [3.15] Heatpump minimum on time

⚙️[016]	<p>Minimum time the heat pump will be kept on after operation has been started, except when the leaving water limits are drastically exceeded<sup>(a)</sup>.</p> <p>This minimum time is used when starting up in space heating/cooling or tank heat-up.</p> <p>When receiving a request to operate the heat pump, there is an initial assessment period of 4 minutes to evaluate the conditions. If the assessment determines that the heat pump should operate, it will run for a minimum time defined by this setting, even if the request drops.</p> <p>If a system, such as the 'Daikin Home Controls system', is installed and capable of closing the emitters via valves, the minimum time defined by this setting must be in line with the opening times of the valves to prevent the heat pump from cycling on and off.</p>
480~1800 seconds (8~30 minutes)	

<sup>(a)</sup> For more information about space heating/cooling, see "[\[3.7\] Max. heating overshoot LWT](#)" [[▶ 102](#)] and "[\[3.9\] Max. cooling undershoot LWT](#)" [[▶ 103](#)]. For tank heat-up, the overshoot depends on an internal limit.

### [3.16] Operation allowance: Cooling

See "[\[3.1\] Operation allowance: Heating / \[3.16\] Operation allowance: Cooling](#)" [[▶ 99](#)]

## [4] Domestic hot water

In this chapter

[4.1] Single heat-up.....	107
[4.2] NOT USED .....	107
[4.3] Manual setpoint.....	107
[4.4] Powerful operation setpoint.....	108
[4.5] Reheat setpoint.....	108
[4.6] Single heat-up schedule.....	108
[4.7] Heat up mode .....	108
[4.8] NOT USED .....	109
[4.9] NOT USED .....	109
[4.10] Disinfection / [4.18] Disinfection enable.....	109
[4.11] Operation range.....	111
[4.12] Hysteresis.....	112
[4.13] DHW pump .....	112
[4.14] Booster heater.....	113
[4.15] NOT USED .....	113
[4.16] Add. source take over during SH/C.....	113
[4.17] Add. source DHW always on request.....	114
[4.18] Disinfection enable.....	114
[4.19] Reheat trigger threshold.....	114
[4.20] Add. source delay timer.....	115
[4.21] NOT USED .....	115
[4.22] NOT USED .....	115
[4.23] Offset BSH setpoint.....	115
[4.24] Enable reheat schedule.....	116
[4.25] Reheat schedule.....	116
[4.26] DHW pump schedule .....	116

### [4.1] Single heat-up

⚙️[N/A]	Single heat-up
	<ul style="list-style-type: none"> <li>▪ <b>Manual:</b> The tank heats up using the heat pump (more efficient) to the temperature setpoint of [4.3] <b>Manual setpoint</b>.</li> <li>▪ <b>Powerful heating:</b> The tank heats up using the backup heater or booster heater, to the temperature setpoint of [4.4] <b>Powerful operation setpoint</b>.</li> </ul>

**Note:** This screen can be accessed from the home screen by tapping on the **Domestic hot water** bar.

### [4.2] NOT USED

### [4.3] Manual setpoint

⚙️[N/A]	<p><b>Restriction:</b> Only applicable if [4.1] = <b>Manual</b>.</p> <p>Setpoint for the tank temperature in <b>Manual</b> mode. See "<a href="#">2.4 Setpoint screen</a>" [▶ 13].</p> <p>Press the <b>Start</b> button to activate the heat-up process.</p> <p><b>Note:</b> To stop an ongoing heat-up process, tap on the <b>Domestic hot water</b> bar from the home screen and press the ⏻ button.</p>
---------	--

## [4.4] Powerful operation setpoint

⚙️[N/A]	<p><b>Restriction:</b> Only applicable if [4.1] = <b>Powerful heating</b>.</p> <p>Setpoint for the tank temperature in <b>Powerful heating</b> mode. See "<a href="#">2.4 Setpoint screen</a>" [▶ 13].</p> <p>Press the <b>Start</b> button to activate the heat-up process.</p> <p><b>Note:</b> To stop an ongoing heat-up process, tap on the <b>Domestic hot water</b> bar from the home screen and press the  button.</p>
---------	--

## [4.5] Reheat setpoint

⚙️[N/A]	<p>You can set the fixed reheat setpoint here.</p> <p>For more information, see "<a href="#">6 Domestic hot water control</a>" [▶ 32].</p>
20~[4.11]°C	

## [4.6] Single heat-up schedule

⚙️[N/A]	<p>Here you can program when the DHW tank needs to heat-up to which temperature.</p>
<p>For more information, see "<a href="#">6 Domestic hot water control</a>" [▶ 32].</p>	

## [4.7] Heat up mode

⚙️[N/A]	<p><b>Restriction:</b> This setting is NOT applicable for ECH<sub>2</sub>O units.</p> <p>Defines how the domestic hot water is prepared. The 3 different ways differ from each other by the way the desired tank temperature is set and how the unit acts upon it.</p> <p>For more information, see "<a href="#">6 Domestic hot water control</a>" [▶ 32].</p>
<ul style="list-style-type: none"> <li>▪ <b>Reheat:</b> The tank can ONLY be heated by reheat operation.</li> <li>▪ <b>Schedule and reheat:</b> The tank is heated according to a schedule and between the scheduled heat up cycles, reheat operation is allowed.</li> <li>▪ <b>Scheduled:</b> The tank can ONLY be heated according to a schedule.</li> </ul>	

To limit the maximum temperature that users can select for the domestic hot water, see "[4.11 Operation range](#)" [▶ 111].

**INFORMATION**

Limit the maximum hot water temperature according to the applicable legislation.

**INFORMATION**

In case of wall-mounted units with standalone tank without internal booster heater: There is a risk of space heating capacity shortage in case of frequent domestic hot water operation. Frequent and long space heating/cooling interruption will happen when selecting **Operation mode = Reheat** (only reheat operation allowed for the tank).

[4.8] NOT USED

[4.9] NOT USED

**[4.10] Disinfection / [4.18] Disinfection enable**

The disinfection function disinfects the domestic hot water tank by periodically heating the domestic hot water to a specific temperature.

**CAUTION**

The disinfection function settings **MUST** be configured by the installer according to the applicable legislation.

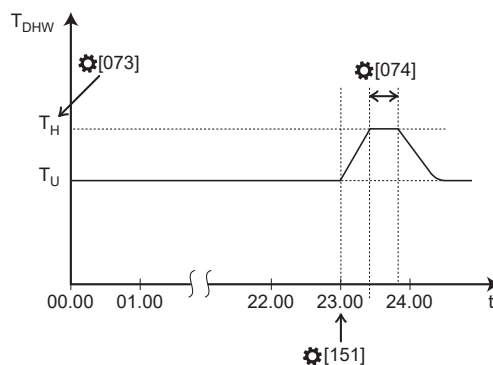

$T_{DHW}$  Domestic hot water temperature  
 $T_U$  User setpoint temperature  
 $T_H$  High setpoint temperature ⚙️[073]  
 $t$  Time

**[4.18] Disinfection enable**

⚙️[072]	Enables/disables the disinfection function.
<ul style="list-style-type: none"> <li>▪ 0: OFF: Disabled</li> <li>▪ 1: ON: Enabled</li> </ul>	

**[4.10] Disinfection > Details > Operation day**

⚙️[150]/ [152]	Defines on which day the disinfection function runs.	
⚙️[150]	⚙️[152]	Operation day
N/A	1	Every day
1	0	Monday
2	0	Tuesday
3	0	Wednesday
4	0	Thursday
5	0	Friday
6	0	Saturday
7	0	Sunday

**[4.10] Disinfection > Details > Start time**

⚙️[151]	Defines at which time the disinfection function starts running.
---------	---

- If set via breadcrumb [4.10] **Disinfection > Details > Start time**: Set the time in the range 00:00~23:59
- If set via field setting ⚙️[151]: Set the time as the amount of minutes counting from 00:00. **Example**: If you want to start at 01:00, then set ⚙️[151]=60.

#### [4.10] Disinfection > Details > Duration

⚙️[074]	Defines how long the disinfection function runs at the target temperature.
<ul style="list-style-type: none"> <li>▪ For wall-mounted units: 5~60 minutes</li> <li>▪ For floor-standing and ECH<sub>2</sub>O units: 40~60 minutes</li> </ul>	

#### [4.10] Disinfection > Tank setpoint > Set temperature to...

⚙️[073]	Defines at which temperature the disinfection function runs.
<ul style="list-style-type: none"> <li>▪ For wall-mounted units: 55°C~[4.11]</li> <li>▪ For floor-standing and ECH<sub>2</sub>O units: 60°C~[4.11]</li> </ul>	



#### WARNING

Be aware that the domestic hot water temperature at the hot water tap will be equal to the value selected in field setting ⚙️[073] after a disinfection operation.

When the high domestic hot water temperature can be a potential risk for human injuries, a mixing valve (field supply) shall be installed at the hot water outlet connection of the domestic hot water tank. This mixing valve shall secure that the hot water temperature at the hot water tap never rises above a set maximum value. This maximum allowable hot water temperature shall be selected according to the applicable legislation.



#### CAUTION

Make sure that the disinfection function start time with defined duration is NOT interrupted by possible domestic hot water demand.



#### NOTICE

**Disinfection mode.** Even if you turn OFF tank heating operation, disinfection mode will remain active (if enabled).



#### NOTICE

##### Disinfection function – "Maintenance mode"

- When maintenance mode is active or whenever you go to [7] **Maintenance mode**, the disinfection function stops / is not executed. However, when exiting maintenance mode, the disinfection function is not automatically restarted.
- If disinfection has failed before entering [7] **Maintenance mode**, the error code AH-00 will disappear. Only when the next scheduled action is triggered, the disinfection function will restart (so not automatically when exiting maintenance mode).

**INFORMATION**

In case of error code AH and no interruption of the disinfection function occurred due to domestic hot water tapping, following actions are recommended:

- When the **Reheat** or **Scheduled reheat** mode is selected, it is recommended to program the start-up of the disinfection function at least 4 hours later than the last expected large hot water tapping. This start-up can be set by installer settings (disinfection function).
- When the **Scheduled** mode is selected, it is recommended to program a scheduled action 3 hours before the start-up of the disinfection function to preheat the tank.

**INFORMATION**

Heat-up during disinfection restarts when the tank temperature drops 1°C below the disinfection setpoint. The duration time is reset when the tank temperature drops 5°C below the disinfection target setpoint.

**[4.11] Operation range**

⚙️[153]	You can set the maximum allowed tank temperature here. This is the maximum temperature that users can select for the domestic hot water. You can use this setting to limit the temperature at the hot water taps.
Maximum temperature for the tank in case of floor-standing units: 65°C	
Maximum temperature for the tank in case of ECH <sub>2</sub> O units: 75°C	

Maximum temperature for the tank in case of wall-mounted units:

- **EKHWS/E 1501** (EKHWS/E 150 l)  
Tank with booster heater installed at side of the tank with a volume of 150 l. Maximum temperature 60°C.
- **EKHWS/E 1801** (EKHWS/E 180 l)  
Tank with booster heater installed at side of the tank with a volume of 180 l. Maximum temperature 60°C.
- **EKHWS/E 2001** (EKHWS/E 200 l)  
Tank with booster heater installed at side of the tank with a volume of 200 l. Maximum temperature 75°C.
- **EKHWS/E 2501** (EKHWS/E 250 l)  
Tank with booster heater installed at side of the tank with a volume of 250 l. Maximum temperature 75°C.
- **EKHWS/E 3001** (EKHWS/E 300 l)  
Tank with booster heater installed at side of the tank with a volume of 300 l. Maximum temperature 75°C.
- **EKHWP/HYC with BSH** (EKHWP/HYC with booster heater)  
Tank with booster heater installed at top. Maximum temperature 80°C.
- **3rd party small coil**  
Third-party tank with a coil size larger than 1.05 m<sup>2</sup>. Maximum temperature 60°C.
- **3rd party big coil**  
Third-party tank with a coil size larger than 1.80 m<sup>2</sup>. Maximum temperature 75°C.

Maximum temperature for the tank in case of \*SU\* units (i.e. UK models):  
60°C



#### INFORMATION

Limit the maximum hot water temperature according to the applicable legislation.

#### [4.12] Hysteresis

⚙️[N/A]	Trigger for slow temperature decrease. This trigger compensates for natural heat losses and intermittent DHW usage. For more information, see " <a href="#">6 Domestic hot water control</a> " [▶ 32].
1~40°C	

#### [4.13] DHW pump

⚙️[149]	Must match your system. If you installed a DHW pump for instant hot water and/or disinfection operation, you must specify its functionality here.  <b>Note:</b> The DHW pump is a <b>Field IO</b> connection: [13] <b>Field IO (DHW pump)</b> .
---------	---

- 0: **None**: DHW pump not installed.
- 1: **Instant hot water**: DHW pump installed for instant hot water when water is tapped. The user sets the operation timing of the domestic hot water pump using the schedule. Control of this pump is possible with the user interface. See "[\[4.26\] DHW pump schedule](#)" [▶ 116].
- 2: **Disinfection**: DHW pump installed for disinfection. It runs when the disinfection function of the domestic hot water tank is running. No further settings are needed.
- 3: **Both**: Combination of **Instant hot water** and **Disinfection**. See "[\[4.26\] DHW pump schedule](#)" [▶ 116].

#### [4.14] Booster heater

**Restriction:** Only applicable for wall-mounted units with the DHW tank with the booster heater.

##### [4.14.1] Booster heater capacity

⚙️[173]	<p>Only applies to domestic hot water tank with an internal booster heater. The capacity of the booster heater at nominal voltage.</p> <p>The capacity of the booster heater must be set for the energy metering and/or power consumption control feature to work properly. When measuring the resistance value of the booster heater, you can set the exact heater capacity and this will lead to more accurate energy data.</p>
1~4 kW	

##### [4.14.2] NOT USED

##### [4.14.3] NOT USED

##### [4.14.4] DHW BSH overshoot temperature

Same as [4.23]. See "[\[4.23\] Offset BSH setpoint](#)" [▶ 115].

#### [4.15] NOT USED

#### [4.16] Add. source take over during SH/C

⚙️[N/A]	<p><b>Restriction:</b> Only applicable for:</p> <ul style="list-style-type: none"> <li>▪ Wall-mounted units with a single thermistor tank Additional heat source = booster heater</li> <li>▪ ECH<sub>2</sub>O units + [5.32] <b>Tank boiler present</b> = ON. Additional heat source = tank boiler</li> </ul> <p>Turns ON/OFF whether an additional heat source is allowed to heat up the tank when the heat pump is running in space heating/cooling.</p> <p><b>Note:</b> Turning ON this setting results in extra power consumption.</p>
<ul style="list-style-type: none"> <li>▪ OFF</li> <li>▪ ON</li> </ul>	

## [4.17] Add. source DHW always on request

⚙️[N/A]	<p><b>Restriction:</b> Only applicable for:</p> <ul style="list-style-type: none"> <li>▪ Wall-mounted units with a single thermistor tank Additional heat source = Booster heater</li> <li>▪ Floor-standing units Additional heat source = Backup heater</li> <li>▪ ECH<sub>2</sub>O units + [5.32] <b>Tank boiler present</b> = ON Additional heat source = Tank boiler</li> <li>▪ ECH<sub>2</sub>O units + [5.32] <b>Tank boiler present</b> = OFF Additional heat source = Backup heater</li> </ul> <p>Turns ON/OFF whether an additional heat source is immediately allowed to assist the heat pump during tank heat-up operation.</p> <p><b>Note:</b> Turning ON this setting results in extra power consumption.</p>
	<ul style="list-style-type: none"> <li>▪ OFF</li> <li>▪ ON</li> </ul>

## [4.18] Disinfection enable

See "[\[4.10\] Disinfection / \[4.18\] Disinfection enable](#)" [▶ 109].

## [4.19] Reheat trigger threshold

⚙️[N/A]	<p>Trigger for rapid temperature decrease. This trigger compensates for DHW consumption.</p> <p>For more information, see "<a href="#">6 Domestic hot water control</a>" [▶ 32].</p>
	10~85°C

## [4.20] Add. source delay timer

⚙️[070]	<p><b>Restriction:</b> Only applicable for:</p> <ul style="list-style-type: none"> <li>▪ Wall-mounted units with a single thermistor tank Add. source = Booster heater</li> <li>▪ Floor-standing units Add. source = Backup heater</li> <li>▪ ECH<sub>2</sub>O units + [5.32] <b>Tank boiler present</b> = ON Add. source = Tank boiler</li> <li>▪ ECH<sub>2</sub>O units + [5.32] <b>Tank boiler present</b> = OFF Add. source = Backup heater</li> </ul> <p>Delay timer for the additional heat source activation when the heat pump is the main source during tank heat-up operation.</p> <p>The delay timer is used to ensure that the heat pump gets enough time to heat up the tank. The additional heat source is triggered when [4.17] <b>Add. source DHW always on request</b> = ON.</p> <p>By adapting delay time versus the maximum running time, you can find an optimal balance between the energy efficiency and the heat-up time.</p> <p>If the delay time is set too high, it might take a long time before the domestic hot water reaches its set temperature.</p> <p><b>Note:</b> The delay timer is not considered (i.e. the additional heat source will immediately assist) in case of:</p> <ul style="list-style-type: none"> <li>▪ A powerful request</li> <li>▪ Space heating priority</li> </ul>
0~10800 seconds. Step: 300 seconds.	

[4.21] NOT USED

[4.22] NOT USED

## [4.23] Offset BSH setpoint

⚙️[064]	<p><b>Restriction:</b> Only applicable for wall-mounted units with the booster heater.</p> <p>Setpoint correction for the desired domestic hot water temperature, to be applied:</p> <ul style="list-style-type: none"> <li>▪ At low outdoor temperature when space heating priority is enabled, OR</li> <li>▪ When the unit is balancing space heating/cooling and domestic hot water operation, and [4.16] <b>Add. source take over during SH/C</b> = ON.</li> </ul> <p>The corrected (higher) setpoint will make sure that the total heat capacity of the water in the tank remains approximately unchanged, by compensating for the colder bottom water layer of the tank (because the heat exchanger coil is not operational) with a warmer top layer.</p>
▪ 0~20°C	

## [4.24] Enable reheat schedule

**Restriction:** Only applicable for ECH<sub>2</sub>O units.

For more information, see "[6 Domestic hot water control](#)" [[▶ 32](#)].

## [4.25] Reheat schedule

**Restriction:** Only applicable for ECH<sub>2</sub>O units.

For more information, see "[6 Domestic hot water control](#)" [[▶ 32](#)].

## [4.26] DHW pump schedule

⚙️[N/A]	<p>Schedule for when the DHW pump is turned ON/OFF in case the DHW pump is used for instant hot water (see "<a href="#">[4.13] DHW pump</a>" [<a href="#">▶ 112</a>]).</p> <p>When turned ON, the pump runs and makes sure hot water is instantly available at the tap. To save energy, only turn ON the pump during periods of the day when instant hot water is necessary.</p> <p><b>Note:</b> This setting is used when <a href="#">[4.13] DHW pump</a> is set to <b>Instant hot water</b> or <b>Both</b>.</p>
<p><b>Predefined schedules:</b> 1</p> <p><b>Activation:</b> Not applicable.</p> <p><b>Possible actions:</b></p> <ul style="list-style-type: none"> <li>▪ Off</li> <li>▪ On</li> </ul>	

## [5] Settings

In this chapter

[5.1] Forced defrost.....	117
[5.2] Quiet operation.....	118
[5.3] Time/date.....	118
[5.4] Breadcrumbs.....	118
[5.5] Backup heater.....	118
[5.6] Capacity shortage.....	120
[5.7] Overview field settings.....	121
[5.8] NOT USED.....	121
[5.9] Location and language.....	121
[5.10] NOT USED.....	121
[5.11] Reset fan operation hours.....	121
[5.12] Keyboard lay-out.....	122
[5.13] Advanced settings.....	122
[5.14] Bivalent settings/Tank boiler settings.....	122
[5.15] NOT USED.....	126
[5.16] NOT USED.....	126
[5.17] Display brightness.....	126
[5.18] System restart.....	126
[5.19] Diverter valve Type.....	126
[5.20] NOT USED.....	126
[5.21] Intelligent tank management.....	126
[5.22] External ambient sensor offset.....	131
[5.23] Emergency selection.....	132
[5.24] NOT USED.....	133
[5.25] NOT USED.....	133
[5.26] Display inactivity timer.....	133
[5.27] Holiday.....	133
[5.28] Balancing.....	133
[5.29] Refrigerant recovery mode.....	135
[5.30] Emergency acknowledgement.....	135
[5.31] NOT USED.....	136
[5.32] Tank boiler present.....	136
[5.33] NOT USED.....	136
[5.34] NOT USED.....	136
[5.35] Pump limitation service.....	136
[5.36] Water pipe freeze prevention.....	136
[5.37] Bivalent present.....	137

### [5.1] Forced defrost

⚙️[N/A]	<p>Manually start a defrost operation. The forced defrost will only start when at least the following conditions are fulfilled:</p> <ul style="list-style-type: none"> <li>▪ Unit is in heating operation and has been running for a few minutes</li> <li>▪ Outdoor ambient temperature is low enough</li> <li>▪ Temperature at the outdoor unit heat exchanger coil is low enough</li> </ul>
<p><b>Are you sure that you want to run a forced defrost?</b></p> <ul style="list-style-type: none"> <li>▪ <b>Cancel</b>: With this button you exit the menu. It does NOT interrupt any ongoing forced defrost (i.e. once a forced defrost is triggered via the user interface, it is NOT possible to stop the request anymore).</li> <li>▪ <b>Confirm</b></li> </ul>	

## [5.2] Quiet operation

⚙️[N/A]	<p>[5.2] Quiet operation</p> <ul style="list-style-type: none"> <li>▪ Off</li> <li>▪ Manual =&gt; [5.2.1] Quiet mode - Manual</li> <li>▪ Scheduled <ul style="list-style-type: none"> <li>- Schedule =&gt; [5.2.2] Quiet operation schedule: Schedule for when the unit has to use which quiet mode level.</li> <li>- Restrictions =&gt; [5.2.8] Restrictions: [5.2.9] [5.2.10] [5.2.11] [5.2.12]: Restrictions configured by the installer based on local regulations.</li> </ul> </li> </ul>
⚙️[138]	<p>[5.2.9] AM Restricted time</p> <p>Start of Day.</p>
⚙️[136]	<p>[5.2.10] AM Restricted level</p> <p>Level used during the Day.</p>
⚙️[139]	<p>[5.2.11] PM Restricted time</p> <p>Start of Night.</p>
⚙️[137]	<p>[5.2.12] PM Restricted level</p> <p>Level used during the Night.</p>
For more information, see " <a href="#">9.2 Using quiet mode</a> " [▶ 58].	

## [5.3] Time/date

⚙️[N/A]	<p>Defines the clock settings on the user interface.</p> <ul style="list-style-type: none"> <li>▪ Date</li> <li>▪ Clock format (24 hours or AM/PM)</li> <li>▪ Time</li> <li>▪ Daylight savings time (ON/OFF)</li> </ul>
---------	---

## [5.4] Breadcrumbs

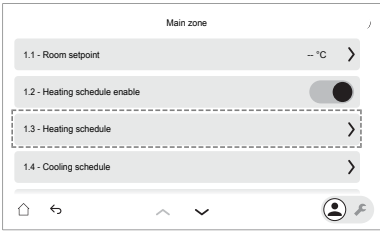
⚙️[N/A]	<p>Enables/disables the breadcrumbs.</p> <p>Breadcrumbs help you to locate where you are in the menu structure of the user interface.</p> <p>Example: <b>[1.3]</b>:</p> 
	<ul style="list-style-type: none"> <li>▪ OFF (disabled): This is the default setting for users and advanced users.</li> <li>▪ ON (enabled)</li> </ul>

## [5.5] Backup heater

[5.5] Backup heater &gt; Grid configuration

⚙️[083]	Must match your system layout. Grid connection type of the backup heater.
<ul style="list-style-type: none"> <li>▪ 0: Single phase</li> <li>▪ 1: Three phase 3x400V+N</li> <li>▪ 2: Three phase 3x230V</li> </ul>	

#### [5.5] Backup heater > Fuse >10A

⚙️[154]	Must match your system layout. Overcurrent fuse for the backup heater in the electrical cabinet.
<ul style="list-style-type: none"> <li>▪ 0: OFF (fuse ≤10 A)</li> <li>▪ 1: ON (fuse &gt;10 A)</li> </ul>	

#### [5.5] Backup heater > Maximum capacity

⚙️[092]	<p>Defines the maximum capacity of the backup heater.</p> <p><b>Note:</b> During defrost operation, the backup heater support may go up to the maximum capacity defined here. If needed, you can limit this value (but not lower than 2 kW to ensure reliable operation).</p>
<p>The maximum capacity suggested by the user interface is based on the selected grid configuration and, if applicable, the size of the fuse. An installer can however lower the maximum capacity of the backup heater using the scroll list.</p> <p>The tables below give an overview of the dynamic maximums of the scroll list.</p>	

#### Maximum capacity in case of floor-standing or wall-mounted units

Grid configuration	Fuse >10A	Maximum capacity	
		4V models	9W models
Single phase	(greyed out)	Limited to 4.5 kW <sup>(a)</sup>	Limited to 6 kW <sup>(a)</sup>
Three phase 3x400V+N	OFF		Limited to 4 kW <sup>(a)</sup>
	ON		Limited to 9 kW <sup>(a)</sup>
Three phase 3x230V	(greyed out)		Limited to 4 kW <sup>(a)</sup>

<sup>(a)</sup> But not lower than 2 kW.

#### Maximum capacity in case of ECH<sub>2</sub>O units

Grid configuration	Fuse >10A	Maximum capacity
Single phase	(greyed out) <sup>(a)</sup>	Limited to 6 kW <sup>(b)</sup>
Three phase 3x400V+N	(greyed out) <sup>(a)(c)</sup>	Limited to 9 kW <sup>(b)</sup>

<sup>(a)</sup> The fuse setting cannot be used (i.e. installing fuses <10A is NOT allowed).

<sup>(b)</sup> But not lower than 2 kW.

<sup>(c)</sup> This functionality is NOT greyed out in early versions of the user interface software.

## [5.6] Capacity shortage

**INFORMATION**

The backup heater logic determines whether to activate the backup heater when the heat pump experiences capacity shortage. The system will ONLY activate the backup heater when:

- The compressor is already running at its maximum capacity, and
- The leaving water temperature setpoint is NOT reached, and
- The leaving water temperature requested at the emitter is NOT reached in a fast enough rate.

**[5.6.1] Capacity shortage setting**

⚙️[N/A]	Defines whether backup heater operation is allowed when the heat pump experiences capacity shortage.
	<ul style="list-style-type: none"> <li>▪ <b>Never:</b> Never allow backup heater operation when the heat pump experiences capacity shortage.</li> <li>▪ <b>Always:</b> Always allow backup heater operation when the heat pump experiences capacity shortage.</li> <li>▪ <b>Below equilibrium:</b> Only allow backup heater operation when the heat pump experiences capacity shortage, and the outdoor temperature is below the equilibrium setpoint.</li> </ul>

**[5.6.2] Equilibrium setpoint**

⚙️[N/A]	<p><b>Restriction:</b> Only applicable if [5.6.1] = <b>Below equilibrium</b>.</p> <p>Defines the outdoor temperature below which backup heater operation is allowed when the heat pump experiences capacity shortage.</p> <p>Adjust the equilibrium setpoint based on your building, location, and personal preference to ensure optimal balance and comfort.</p> <p>For more information about the maximum capacity of the heat pump, see <a href="https://daikintechnicaldatahub.eu/">https://daikintechnicaldatahub.eu/</a></p>
	-15~35°C

**NOTICE**

For houses with a similar heat load as the declared heating capacity on the energy label, it is recommended to set the [5.6.2] **Capacity shortage setting** to 2 (**Below equilibrium**) and decrease the equilibrium setpoint [5.6.2] **Equilibrium setpoint** to the declared bivalent temperature of -10°C. (refer to product fiche in accessory bag or the online energy label database (see: <https://daikintechnicaldatahub.eu/>)).

**INFORMATION**

Applicable if [5.6.1] = **Below equilibrium**:

Above 10°C ambient temperature, the heat pump will operate until 70°C. Configuring a higher setpoint with an ambient temperature that is higher than the set equilibrium temperature will prevent the backup heater from assisting. The backup heater will ONLY assist if you increase the equilibrium temperature [5.6.2] to the required ambient temperature you need to reach the higher setpoint.

## [5.7] Overview field settings

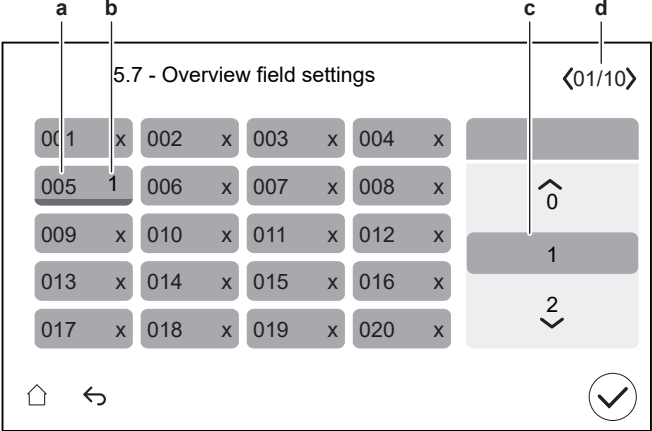
<p>⚙️[N/A]</p>	<p>Almost all settings can be done using the menu structure. If for any reason it is required to change a setting using the overview settings, then the overview of the field settings can be accessed here.</p> <p>Where applicable, the field setting codes are described in the configuration reference guide, and in the field settings table of the installer reference guide.</p> <p>Field codes that are not applicable are greyed out.</p>
 <p><b>a</b> Field setting code</p> <p><b>b</b> Selected value</p> <p><b>c</b> To select the wanted value</p> <p><b>d</b> To browse through the different pages</p>	

[5.8] NOT USED

## [5.9] Location and language

<p>⚙️[N/A]</p>	<p>Defines the location and language on the user interface.</p>
<ul style="list-style-type: none"> <li>▪ Country</li> <li>▪ Language</li> </ul> <p><b>Note:</b> The default <b>Language</b> is indicated with a white circle on the left side of the selector.</p>	

[5.10] NOT USED

## [5.11] Reset fan operation hours

<p>⚙️[N/A]</p>	<p>Resets the fan operation hours.</p> <p>Fan operation hours need to be reset in two cases:</p> <ul style="list-style-type: none"> <li>▪ When warning H7–31 is triggered by the outdoor unit, the fan motor needs to be replaced, and the fan hours need to be reset to clear the warning. This will be indicated on the error screen.</li> <li>▪ When the fan motor is replaced for another reason, fan operation hours also need to be reset.</li> </ul>
----------------	---



Confirm to reset the fan operation hours.

- Cancel
- Confirm

### [5.12] Keyboard lay-out

⚙️[N/A]	Defines the keyboard layout on the user interface.
	<ul style="list-style-type: none"> <li>▪ QWERTY</li> <li>▪ AZERTY</li> </ul>

### [5.13] Advanced settings

⚙️[N/A]	<p>There are three permission levels, which define what you can see and do on the user interface:</p> <ul style="list-style-type: none"> <li>▪ User mode</li> <li>▪ Advanced user mode</li> <li>▪ Installer mode</li> </ul> <p>On the home screen, and most other screens where applicable, you can switch between user and installer mode.</p> <ul style="list-style-type: none"> <li>▪  : User mode.</li> <li>▪  : Installer mode. Pin code: 5678.</li> </ul> <p>Via setting [5.13] you can switch between user mode and advanced user mode.</p> <p><b>Note:</b> When you switch from installer mode to user mode while [5.13] was switched ON (advanced user mode), you will have to manually turn OFF—turn ON [5.13] to enable advanced user mode again.</p>
	<ul style="list-style-type: none"> <li>▪ OFF (user mode)</li> <li>▪ ON (advanced user mode)</li> </ul>

### [5.14] Bivalent settings/Tank boiler settings

If...	Then [5.14] = ...
A bivalent is present (this is defined in [5.37] <b>Bivalent present</b> , or in the configuration wizard [10.4] <b>Bivalent</b> )	<b>Bivalent settings</b>
A tank boiler is present (this is defined in [5.32] <b>Tank boiler present</b> , or in the configuration wizard [10.6] <b>Tank boiler</b> )	<b>Tank boiler settings</b>

For more information about setting up bivalent heat sources, see the application guidelines chapter in the installer reference guide.

**INFORMATION**

Bivalent is ONLY possible in case of ONE leaving water temperature zone with:

- room thermostat control, OR
- external room thermostat control.

Applicable settings:

Setting	Applicability	
	If bivalent is present	If tank boiler is present
[5.14.6] Post-run timer	Yes	No
[5.14.1] Tank boiler covers heat demand	No	Yes
[5.14.4] Bivalent hysteresis	Yes	Yes
[5.14.2] Operation range > Upper limit	Yes	Yes
[5.14.2] Operation range > Lower limit	Yes	Yes
[9.3] Electricity price schedule enable	Yes	Yes
[9.13] Energy price considered	Yes	Yes
[9.12] PE factor	No	Yes
[9.11] Boiler efficiency	Yes	Yes
[9.5] Gas price	Yes	Yes

If there is no tank boiler available, or bivalent through headers is not available (fossil heat sources), the heat pump (renewable heat source) will always be decided as the main heat source for space heating and for tank heat-up.

### Bivalent for space heating

If bivalent through headers or tank boiler is available, the main heat source will be decided based on a comparison between the efficiencies of both heat sources. The decision on which source to select depends on setting [9.13] **Energy price considered**. This setting defines if the inputted energy prices are considered or not.

**When energy prices are considered (i.e. [9.13] Energy price considered = ON):**

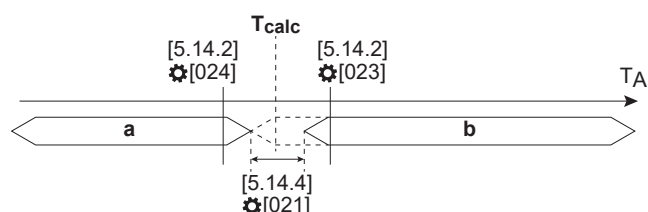

- a** Fossil heat source
- b** Renewable heat source
- T<sub>A</sub>** Outdoor ambient temperature
- T<sub>calc</sub>** Changeover temperature calculated by the software.

The main heat source will be decided based on the bivalent changeover condition with dedicated ambient boundaries selected by the installer ([5.14.2] **Operation range**: upper and lower limit).

See selection [5.14.2] **Operation range**. The changeover will happen around that temperature with a dedicated hysteresis ([5.14.4] **Bivalent hysteresis**); standard there will be an minimum hysteresis of 2°C included.

The changeover temperature ( $T_{calc}$ ) is calculated based on:

- Break-even COP (Coefficient of Performance), which in turn depends on:
  - Ratio of electricity and gas prices
  - Boiler efficiency
- Heat pump efficiency determined by:
  - Outdoor ambient temperature
  - Target leaving water temperature (in case of a bivalent boiler)

**When energy prices are NOT considered ([9.13] Energy price considered = OFF)**

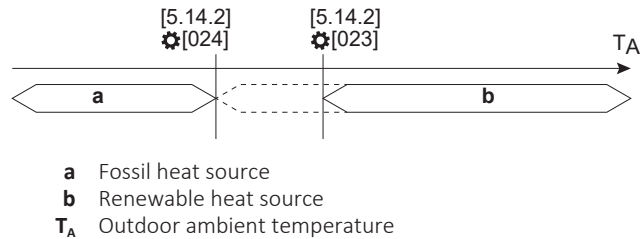

The main heat source will be decided based on the ambient boundaries selected by the installer ([5.14.2] **Operation range**: Upper and lower limit). This case is mainly capacity driven (where below the ambient condition the boiler will cover the space heating capacity).

**Heat source selection for the tank heat-up**

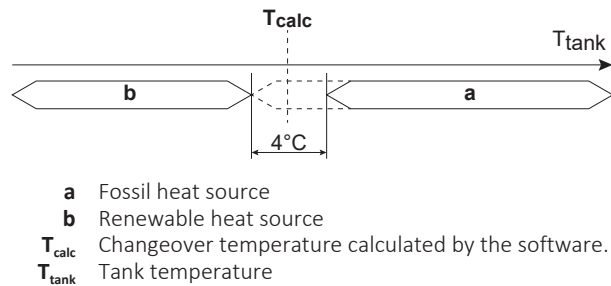

If a tank boiler is available, the main heat source will be decided based on a comparison between the efficiencies of both heat sources. The decision on which source to select depends on setting [9.13] **Energy price considered**. This setting defines if the inputted energy prices are considered or not.

**When energy prices are considered (i.e. [9.13] Energy price considered = ON):**

The changeover temperature ( $T_{calc}$ ) is calculated based on:

- Break-even COP (Coefficient of Performance), which in turn depends on:
  - Ratio of electricity and gas prices
  - Boiler efficiency
- Heat pump efficiency determined by:
  - Outdoor ambient temperature

When the storage tank temperature reaches  $T_{\text{calc}}$  (including a hysteresis), the tank boiler is set as primary heat source.

**When energy prices are NOT considered ([9.13] Energy price considered = OFF):**

If electricity and gas prices are not known, the PE factor (primary energy factor) is used for the calculation of the break-even COP. Lower values of the PE factor result in increased use of the heat pump. Higher values of the PE factor result in increased use of the tank boiler.

#### [5.14.1] Tank boiler covers heat demand

⚙️[012]	<p><b>Restriction:</b> Only applicable for units with tank boiler.</p> <p>Defines whether the capacity of the installed tank boiler is sufficient to cover the complete load of the house. If so, it can become the main heat source.</p> <p>If the heat pump is forced off by a demand response, the tank boiler will take over. However, if the water temperature in the tank is low, it may take some time to heat up the tank to support space heating. Therefore, only turn ON this setting if the boiler has a minimum power output of 12 kW.</p>
	<ul style="list-style-type: none"> <li>▪ 0: OFF (tank boiler capacity does not cover heat demand): The auxiliary boiler is too small to cover the building demand and is used solely as backup heat source. Therefore, the heat pump is the only available primary heat source.</li> <li>▪ 1: ON (tank boiler capacity covers heat demand): The auxiliary boiler is large enough to cover the heat demand of the building and can therefore be considered as additional primary heat source. Therefore, the choice between operation of auxiliary boiler and heat pump should be done by efficiency calculation.</li> </ul>

#### [5.14.2] Operation range

The lower limit has priority over upper limit.

Upper limit:

⚙️[023]	Defines the upper outdoor temperature limit of the changeover point from heat pump to bivalent/tank boiler.
max([024]+2; -25)~25°C	

Lower limit:

⚙️[024]	Defines the lower outdoor temperature limit of the changeover point from heat pump to bivalent/tank boiler.
-25~25°C	

#### [5.14.3] NOT USED

#### [5.14.4] Bivalent hysteresis

⚙️[021]	<p><b>Restriction:</b> Only applicable if the setting [9.13] Energy price considered is enabled.</p> <p>Defines the hysteresis on the outdoor temperature for the changeover from heat pump to bivalent.</p>
2~10°C	

**[5.14.5] NOT USED****[5.14.6] Post-run timer**

⚙️[025]	<p>Defines the minimum time the bivalent boiler pump in space heating stays on after the request has stopped.</p> <p>This timer is triggered from the moment bivalent is switched OFF. It prevents going to another mode as long as the timer is running. During this time the bivalent bypass valve remains open to ensure flow over the indoor unit.</p> <p><b>Note:</b> It is possible that when two pumps operate in parallel circuits, one of the two circuits may experience no flow.</p> <p>This setting will have to be adapted according to the post-run timer of the boiler pump when the request stops. Please check with the boiler manufacturer for the correct value.</p>
0~1500 seconds	

**[5.14.7] NOT USED****[5.14.8] NOT USED**

[5.15] NOT USED

[5.16] NOT USED

**[5.17] Display brightness**

⚙️[N/A]	Defines the brightness of the user interface.
30~100%	

**[5.18] System restart**

⚙️[N/A]	Manually restart the system.
<p>Are you sure that you want to restart the entire system?</p> <ul style="list-style-type: none"> <li>▪ Cancel</li> <li>▪ Confirm</li> </ul>	

**[5.19] Diverter valve Type**

⚙️[196]	<p><b>Restriction:</b> Only for floor-standing units.</p> <p>If you have to replace the diverter valve, you have to specify the type of the new one here.</p>
<p>1: YJS Profile 1</p> <p>2: Danfoss Profile 1</p>	

[5.20] NOT USED

**[5.21] Intelligent tank management****Restriction:** Only applicable for ECH<sub>2</sub>O units.

### General intelligent tank settings

Settings	<ul style="list-style-type: none"> <li>▪ [5.21.1] Tank energy for space heating during defrost</li> <li>▪ [5.21.2] Enable proactive tank heating</li> <li>▪ [5.21.3] Tank support</li> <li>▪ [5.21.4] Tank support maximum capacity</li> </ul>
----------	--

### Free energy functionality

Settings	<ul style="list-style-type: none"> <li>▪ [5.21.5] Allow free energy</li> <li>▪ [5.21.6] Free energy maximum capacity</li> <li>▪ [5.21.7] Free energy main source</li> <li>▪ [5.21.8] Free energy outdoor threshold</li> </ul>
What	<p>Free energy is stored energy from an uncontrollable heat source. An uncontrollable heat source cannot be shut off. Examples of installations that can provide free energy:</p> <ul style="list-style-type: none"> <li>▪ Solar collector system. The amount of energy cannot be controlled or shut off by the indoor unit.</li> <li>▪ Stove. The amount of energy cannot be controlled or shut off by the indoor unit.</li> </ul> <p>If the measured tank temperature is above the tank setpoint and space heating setpoint including an offset value, the unit decides that there is free energy available.</p> <p>Free energy cannot only come from the extra heat source. Free energy can also become available when the schedule changes the DHW setpoint from a high DHW setpoint to a low DHW setpoint.</p> <p>You can see the free energy status in [6.5.13] Tank support:</p> <ul style="list-style-type: none"> <li>▪ Not allowed</li> <li>▪ Allowed (tank boiler)</li> <li>▪ Allowed (free energy)</li> </ul>

### Solar energy functionality

Settings	<ul style="list-style-type: none"> <li>▪ [5.21.9] Thermal solar energy</li> <li>▪ [5.21.10] Thermal solar priority</li> </ul> <p>If both settings are ON, the solar energy functionality is enabled. If one of the parameters is OFF, the functionality is disabled.</p>
----------	--

What	<p>The solar energy functionality prevents tank heat-ups by active heat sources (heat pump, backup heater, tank boiler) when free solar energy is available.</p> <p>Whether free solar energy is available is determined by a <b>Field IO</b> input (<b>Solar input</b>). You can see its status in [6.3.26] <b>Solar input</b> (OFF/ON).</p> <p>When the solar energy functionality is enabled, then:</p> <ul style="list-style-type: none"> <li>▪ The following triggers are <b>blocked</b>: <ul style="list-style-type: none"> <li>- Reheat because of DHW consumption (rapid temperature decrease)</li> <li>- Reheat because of natural heat losses (slow temperature decrease)</li> </ul> </li> <li>▪ The following triggers are <b>allowed</b>: <ul style="list-style-type: none"> <li>- Single heat-ups: disinfection, manual heat-up, powerful heat-up</li> <li>- Preheating</li> <li>- Tank buffering in case of demand response</li> </ul> </li> </ul>
------	--

#### [5.21.1] Tank energy for space heating during defrost

⚙️[N/A]	<p><b>Restriction:</b> Only applicable for ECH<sub>2</sub>O units.</p> <p>Defines how the tank can support during defrost operation to compensate for the space heating demand.</p>
	<ul style="list-style-type: none"> <li>▪ <b>Disabled:</b> Space heating is interrupted while the heat pump is in defrost operation. If the water temperatures drop below their limits, the plate heat exchanger will be protected by using the energy from the tank.</li> <li>▪ <b>Optimized:</b> There are 3 possibilities depending on the tank temperature: <ul style="list-style-type: none"> <li>- In case of high tank temperature: <p>Space heating is provided from energy stored in the tank while the heat pump is in defrost operation (same as <b>Continuous</b>)</p> </li> <li>- In case of lower tank temperature but above the DHW setpoint: <p>The defrost energy is compensated with the tank energy.</p> </li> <li>- In case of low tank temperature: <p>Space heating is interrupted, and the energy from the circuit is used to compensate the defrost energy. If the water temperatures drop, it will use the energy from the tank (same as <b>Disabled</b>)</p> </li> </ul> </li> <li>▪ <b>Continuous:</b> Space heating is provided from energy stored in the tank while the heat pump is in defrost operation.</li> </ul>

#### [5.21.2] Enable proactive tank heating

⚙️[002]	<p><b>Restriction:</b> Only applicable if [5.32] <b>Tank boiler present</b> = ON (installed).</p> <p>Enables/disables the domestic hot water tank to be proactively preheated by the tank boiler to the proactive setpoint. With this high tank temperature, failed defrosts can be avoided as much as possible without any interruption of the space heating operation.</p>
	<ul style="list-style-type: none"> <li>▪ 0: OFF (disabled)</li> <li>▪ 1: ON (enabled)</li> </ul>

**INFORMATION**

When the setting [5.21.2] **Enable proactive tank heating** is enabled and a very low value in [4.19] **Reheat trigger threshold** is set, the heat pump might heat up the tank more frequently.

**[5.21.3] Tank support**

⚙️[N/A]	<p><b>Restriction:</b> Only applicable if [5.32] <b>Tank boiler present</b> = ON (installed).</p> <p>Allows/disallows the domestic hot water tank to support the space heating operation by adding capacity to the space heating circuit.</p> <p>Set this value in case the auxiliary boiler is connected to the storage tank, and the heat generated by the auxiliary boiler has to be used for domestic hot water heating and for space heating support.</p>
<ul style="list-style-type: none"> <li>▪ 0: OFF (disallowed)</li> <li>▪ 1: ON (allowed)</li> </ul> <p><b>Note:</b> In case [5.21.3] is activated and there is a very high space heating setpoint, high tank temperatures might occur allowing the tank valve to open for space heating support when the heat pump is not considered as the main heat source.</p>	

**[5.21.4] Tank support maximum capacity**

⚙️[188]	<p><b>Restriction:</b> Only applicable if [5.32] <b>Tank boiler present</b> = ON (installed).</p> <p>Defines the maximum deliverable thermal capacity in the space heating circuit by the domestic hot water tank during tank support.</p> <p>Limiting the capacity used for tank heating support will prevent the heating support function from taking too much energy from the tank in a short time.</p>
4~35 kW	

**[5.21.5] Allow free energy**

⚙️[184]	<p><b>Restriction:</b> Only applicable for ECH<sub>2</sub>O units.</p> <p>Enables/disables the free energy functionality of the tank.</p>
<ul style="list-style-type: none"> <li>▪ 0: OFF (disabled): Tank will never be used for space heating.</li> <li>▪ 1: ON (enabled): Tank will be used for space heating.</li> </ul>	

**[5.21.6] Free energy maximum capacity**

⚙️[187]	<p><b>Restriction:</b> Only applicable if [5.21.5] <b>Allow free energy</b> = ON (enabled).</p> <p>Defines the maximum deliverable thermal capacity in the space heating circuit by the domestic hot water tank during free energy functionality (when the tank is very hot).</p> <p>Limiting the capacity will prevent the free energy functionality from taking too much energy from the tank in a short time.</p>
2~35 kW	

**[5.21.7] Free energy main source**

⚙️[182]	<p><b>Restriction:</b></p> <ul style="list-style-type: none"> <li>▪ Only applicable if [5.21.5] <b>Allow free energy</b> = ON (enabled).</li> <li>▪ Free energy is not available as main heat source during disinfection operation.</li> </ul> <p>Defines whether free energy is allowed to be the main heat source for space heating (when the tank is very hot).</p>
	<ul style="list-style-type: none"> <li>▪ 0: <b>Always:</b> Always allow free energy to be the main heat source for space heating (when the tank is very hot).</li> </ul>
	<ul style="list-style-type: none"> <li>▪ 1: <b>Above ambient:</b> Only allow free energy to be the main heat source for space heating (when the tank is very hot) when the outdoor temperature is above [5.21.8] <b>Free energy outdoor threshold</b> (+ hysteresis).</li> </ul> <p>This can be useful to compensate heat losses of the building. If a legal limit would be applied that you are not allowed to use the heat pump for 2 hours, then you need to buffer hot water. When the outdoor temperature drops, you would need a larger buffer because the installation will require more hot water for space heating to keep the building at the requested indoor temperature. It is not possible to increase the size of the tank when the outdoor temperature is low. However, it is possible to lower the capacity of the tank (e.g. maximum 3 kW). Then, you can calculate the amount of kW/h and limit the output space heating valve to that value.</p> <p>The logic must only select this free energy as the main source at a certain outdoor temperature, otherwise you will not be able to reach the requested indoor temperature (the outdoor temperature must match the heat losses of the building).</p>
	<ul style="list-style-type: none"> <li>▪ 2: <b>Never:</b> Never allow free energy to be the main heat source for space heating (when the tank is very hot).</li> </ul>

**[5.21.8] Free energy outdoor threshold**

⚙️[183]	<p><b>Restriction:</b> Only applicable if [5.21.7] <b>Free energy main source</b> = <b>Above ambient</b>.</p> <p>Defines the outdoor temperature above which the free energy is allowed to be the main heat source for space heating (when the tank is very hot).</p>
	-28~35°C

**[5.21.9] Thermal solar energy**

⚙️[185]	<p><b>Restriction:</b> Only applicable for ECH<sub>2</sub>O units.</p> <p>Must match your system layout. Defines whether a solar system is installed on the tank.</p>
	<ul style="list-style-type: none"> <li>▪ 0: OFF (not installed)</li> <li>▪ 1: ON (installed)</li> </ul>

**[5.21.10] Thermal solar priority**

⚙️[186]	<p><b>Restriction:</b> Only applicable if [5.21.9] <b>Thermal solar energy</b> = ON (installed).</p> <p>Defines whether the installed solar system has priority over other heat sources.</p>
---------	--

- 0: OFF (other heat sources have priority): The heat pump and the boiler can operate also while solar energy is provided.
- 1: ON (solar system has priority):
  - When solar energy is provided, DHW reheats due to tapping or heat losses are blocked.
  - The indoor unit cannot see how much solar energy is entering the installation. In winter time, it is possible that the solar energy is low. Therefore, this setting is not recommended for solar collector systems with an overall low thermal output.

## [5.22] External ambient sensor offset

### [5.22] External ambient sensor offset > Outdoor

⚙️[175]	<p><b>Restriction:</b> Only applicable in case an external <b>outdoor</b> ambient temperature sensor is connected.</p> <p>You can calibrate the external outdoor ambient temperature sensor. It is possible to give an offset to the thermistor value. This setting can be used to compensate for situations where the sensor cannot be installed on the ideal installation location.</p> <p><b>Note:</b> The external <b>outdoor</b> ambient temperature sensor is a <b>Field IO</b> connection:</p> <ul style="list-style-type: none"> <li>▪ [13] <b>Field IO (External outdoor sensor)</b></li> </ul>
-5~5°C	

### [5.22] External ambient sensor offset > Room

⚙️[N/A]	<p><b>Restriction:</b> Only applicable if:</p> <ul style="list-style-type: none"> <li>▪ [1.12] = <b>Room</b>, and</li> <li>▪ an external <b>indoor</b> ambient temperature sensor is connected.</li> </ul> <p>You can calibrate the external indoor ambient temperature sensor. It is possible to give an offset to the thermistor value. This setting can be used to compensate for situations where the sensor cannot be installed on the ideal installation location.</p> <p>Same as setting [1.33] <b>External room sensor offset</b>.</p> <p><b>Note:</b> The external <b>indoor</b> ambient temperature sensor is a <b>Field IO</b> connection:</p> <ul style="list-style-type: none"> <li>▪ [13] <b>Field IO (External indoor sensor)</b></li> </ul>
-5~5°C	

## [5.23] Emergency selection

⚙️[N/A]	<p>When a heat pump failure occurs, then setting [5.23] defines whether the electrical heater (backup heater / booster heater / tank boiler if applicable) can take over the space heating and DHW operation.</p> <p>When there is no automatic full take-over by the electrical heater, a pop-up (with the same content as "<a href="#">[5.30] Emergency acknowledgement</a>" [▶ 135]) appears where you can manually acknowledge that the electrical heater can fully take over (i.e. space heating to normal setpoint and DHW operation = ON).</p> <p>When the house is unattended for longer periods, we recommend to use <b>auto SH reduced/DHW off</b> to keep energy consumption low.</p>	
[5.23]	When heat pump failure occurs, then there is ... by the electrical heater	Full take-over
Manual	No take-over: <ul style="list-style-type: none"> <li>▪ Space heating = OFF</li> <li>▪ DHW operation = OFF</li> </ul>	After manual acknowledgment
Automatic	Full take-over: <ul style="list-style-type: none"> <li>▪ Space heating to normal setpoint</li> <li>▪ DHW operation = ON</li> </ul>	Automatic
auto SH reduced/DHW on	Partial take-over: <ul style="list-style-type: none"> <li>▪ Space heating to reduced setpoint</li> <li>▪ DHW operation = ON</li> </ul>	After manual acknowledgment
auto SH reduced/DHW off	Partial take-over: <ul style="list-style-type: none"> <li>▪ Space heating to reduced setpoint</li> <li>▪ DHW operation = OFF</li> </ul>	After manual acknowledgment
auto SH normal/DHW off	Partial take-over: <ul style="list-style-type: none"> <li>▪ Space heating to normal setpoint</li> <li>▪ DHW operation = OFF</li> </ul>	After manual acknowledgment

**INFORMATION**

If a heat pump failure occurs and **Emergency selection** is NOT set to **Automatic**, the following functions will remain active even if the user does NOT acknowledge emergency operation:

- Room frost protection
- Underfloor heating screed dryout
- Water pipe freeze prevention
- Disinfection

[5.24] NOT USED

[5.25] NOT USED

**[5.26] Display inactivity timer**

Recommended to NOT change this setting (i.e. leave switched ON). This setting is mainly meant for testing purposes during the development process of the user interface software.

⚙️[N/A]	Enables/disables the inactivity timer. When enabled, the timer is used to automatically: <ul style="list-style-type: none"> <li>▪ Return to the home screen</li> <li>▪ Dim the backlight</li> <li>▪ Turn OFF the backlight</li> </ul>
	<ul style="list-style-type: none"> <li>▪ OFF (disabled)</li> <li>▪ ON (enabled)</li> </ul>

**[5.27] Holiday**

⚙️[N/A]	[5.27.1] Holiday mode
⚙️[N/A]	[5.27.2] Holiday period
See "9.3 Using holiday mode" [▶ 60].	

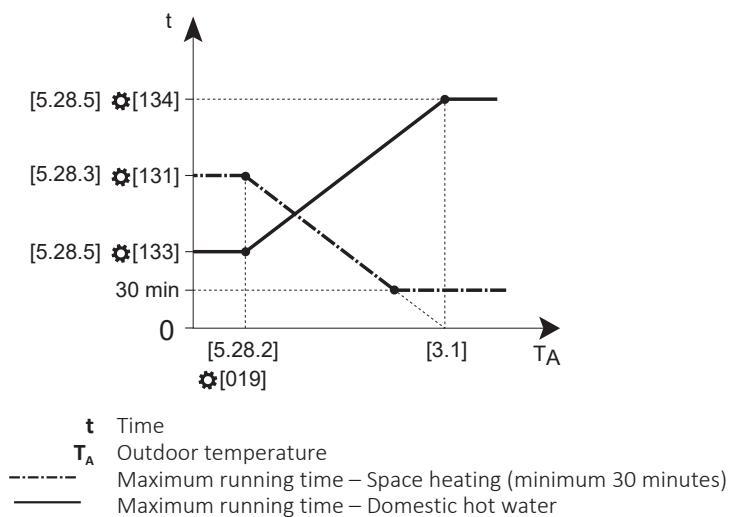
**[5.28] Balancing****Balancing space heating**

### Balancing space cooling

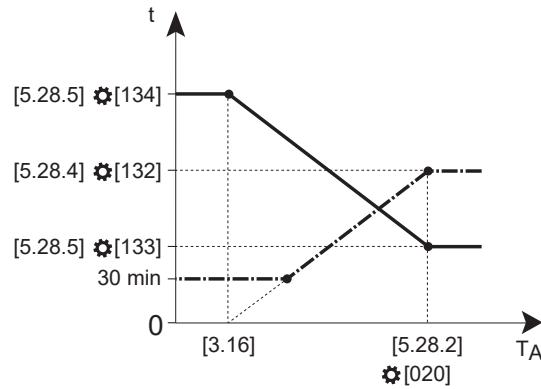

- t Time
- $T_A$  Outdoor temperature
- - - - - Maximum running time – Space cooling (minimum 30 minutes)
- Maximum running time – Domestic hot water

#### [5.28.1] Space heating priority

<p>⚙️[140]</p>	<p>Enables/disables the space heating priority functionality.</p> <p>In case of wall-mounted units: Defines whether domestic hot water is made by booster heater only when outdoor temperature is below the space heating priority temperature (see [5.28.2]).</p> <p>In case of floor-standing units: Defines whether backup heater will assist the heat pump during domestic hot water operation.</p> <p>If there is a parallel bivalent system installed, the bivalent system will take over the heat demand below the space heating priority temperature so the heat pump and backup heater can fully cover the tank heat-up demand.</p> <p><b>Note:</b></p> <ul style="list-style-type: none"> <li>▪ In case a bivalent system is enabled, the boiler will take over for space heating.</li> <li>▪ In case a tank boiler is enabled (only for ECH<sub>2</sub>O units), the tank boiler will take over the tank heat-up.</li> <li>▪ In case of wall-mounted units, the booster heater will take over the tank heat-up.</li> </ul>
<ul style="list-style-type: none"> <li>▪ 0: OFF (disabled)</li> <li>▪ 1: ON (enabled)</li> </ul>	

#### [5.28.2] Priority temperatures

Space heating:

<p>⚙️[019]</p>	<p>Outdoor temperature where the space heating operation timer is at its minimum value.</p> <p>Below this outdoor temperature, the space heating priority function is activated (if enabled).</p>
<p>–15~35°C</p>	

Space cooling:

<p>⚙️[020]</p>	<p>Outdoor temperature where the space cooling operation timer is at its maximum value.</p>
<p>20~50°C</p>	

**[5.28.3] Max. space heating timer**

⚙️[131]	Time that heat pump is reserved for space heating operation during balancing. Balancing = simultaneous requests for space heating and tank heat-up.
1800~36000 seconds (step: 60 seconds)	

**[5.28.4] Max. space cooling timer**

⚙️[132]	Time that heat pump is reserved for space cooling operation during balancing. Balancing = simultaneous requests for space cooling and tank heat-up.
1800~36000 seconds (step: 60 seconds)	

**[5.28.5] Max. DHW timer**

Lower limit:

⚙️[133]	Time that heat pump is reserved for tank heat-up operation during balancing (lower limit). Balancing = simultaneous requests for space heating/cooling and tank heat-up.
900~18000 seconds (step: 60 seconds)	

Upper limit:

⚙️[134]	Time that heat pump is reserved for tank heat-up operation during balancing (upper limit). Balancing = simultaneous requests for space heating/cooling and tank heat-up.
900~18000 seconds (step: 60 seconds)	

**[5.29] Refrigerant recovery mode**

⚙️[N/A]	Refrigerant recovery mode. This mode blocks heat pump operation, and opens all valves in the outdoor unit. This enables the installer (with required level of competences to handle R290 refrigerant) to recover all refrigerant from the outdoor unit in a complete and safe way.
For more information about refrigerant recovery, see the disposal chapter in the installer reference guide.	

**[5.30] Emergency acknowledgement**

⚙️[N/A]	When a heat pump failure occurs, then setting " <b>[5.23] Emergency selection</b> " [▶ 132] defines whether the electrical heater (backup heater and/or booster heater if applicable) can take over the space heating and DHW operation.  If manual acknowledgement is needed for full take-over, a pop-up (with same content as [5.30]) appears where you can activate emergency.
---------	--

Error has led to the malfunction of the heat pump. To ensure normal comfort the electrical heater can take over, after acknowledgement. Attention: Electrical consumption can be increased.

- **Cancel.** No full take-over by the electrical heater (i.e. the unit keeps running in the original state as defined in setting [5.23]).
- **Activate emergency:** Full take-over by the electrical heater (i.e. space heating to normal setpoint and DHW operation = ON).

[5.31] NOT USED

### [5.32] Tank boiler present

⚙️[078]	<p><b>Restriction:</b></p> <ul style="list-style-type: none"> <li>▪ Only applicable for EPSXB* units.</li> <li>▪ This setting cannot be turned ON if [5.37] <b>Bivalent present</b> = ON (installed).</li> </ul> <p>Must match your system layout. Defines whether a tank boiler is installed and allowed to operate.</p> <p>For more information about setting up bivalent heat sources, see the application guidelines chapter in the installer reference guide.</p>
	<ul style="list-style-type: none"> <li>▪ 0: OFF (not installed)</li> <li>▪ 1: ON (installed)</li> </ul>

[5.33] NOT USED

[5.34] NOT USED

### [5.35] Pump limitation service

This setting is only used for service purposes.

### [5.36] Water pipe freeze prevention

⚙️[005]	<p>Only relevant for installations with water piping outdoors.</p> <p>This function protects the outdoor water piping from freezing by activating the pump and, if required, the electrical heater.</p>
	<ul style="list-style-type: none"> <li>▪ 0: <b>Disabled</b></li> <li>▪ 1: <b>Continuous:</b> There is a continuous water flow through the system. This setting can be used if the water piping is poorly insulated.</li> <li>▪ 2: <b>Intermittent:</b> There is an intermittent water flow through the system. This setting can be used if the water piping is well insulated.</li> </ul> <p>For information about the correct insulation selection, see the connecting water piping chapter of the installer reference guide.</p>



#### NOTICE

Do NOT disable water pipe freeze protection as it can lead to the drainage of the system, or even damage to the water pipes.

### [5.37] Bivalent present

⚙️[093]	<p><b>Restriction:</b> This setting cannot be turned ON if [5.32] <b>Tank boiler present</b> = ON (installed).</p> <p>Must match your system layout. Defines whether the additional boiler kit for space heating is installed and allowed to operate.</p> <p>For more information about setting up bivalent heat sources, see the application guidelines chapter in the installer reference guide.</p> <ul style="list-style-type: none"><li>▪ 0: OFF (not installed): Space heating is only done by the heat pump within the operation range. The permission signal for the auxiliary boiler is always inactive.</li><li>▪ 1: ON (installed): When the outdoor temperature drops below the bivalent ON temperature (fixed or variable based on energy prices), the space heating by the heat pump stops automatically and the permission signal for the auxiliary boiler is active.</li></ul>
---------	--

For more information, see also "[\[5.14\] Bivalent settings / Tank boiler settings](#)" [▶ 122].

## [6] Information

In this chapter

[6.1] NOT USED .....	138
[6.2] Dealer information .....	138
[6.3] Sensors .....	138
[6.4] Actuators .....	138
[6.5] Operation modes .....	139
[6.6] About .....	141
[6.7] Indoor unit model name / [6.8] Indoor unit serial number .....	141

### [6.1] NOT USED

### [6.2] Dealer information

⚙️[N/A]	<p>Enables you to enter the dealer's contact details:</p> <ul style="list-style-type: none"> <li>▪ Dealer</li> <li>▪ Phone number</li> <li>▪ Address</li> <li>▪ Postal code</li> <li>▪ City</li> </ul>
<p>To edit:</p> <ol style="list-style-type: none"> <li>1 Tap  .</li> <li>2 Enter <b>Name of the dealer</b>, and confirm with the  button.</li> <li>3 Enter <b>Phone number of the dealer</b>, and confirm with the  button.</li> <li>4 Enter <b>Address of the dealer</b>, and confirm with the  button.</li> <li>5 Enter <b>Postal code of the dealer</b>, and confirm with the  button.</li> <li>6 Enter <b>City of the dealer</b>, and confirm with the  button.</li> </ol>	

### [6.3] Sensors

⚙️[N/A]	Shows (read-only) the readout (temperatures, pressures, flow rates) of each sensor.
---------	---

### [6.4] Actuators

⚙️[N/A]	<p>Shows (read-only) the status/mode of each actuator.</p> <p><b>Example:</b> [6.4.2] DHW pump = Off</p> <p><b>Note:</b> For the following two pumps, the logic is reversed: 0% means the pump will go to full speed, and 100% means the pump is OFF:</p> <ul style="list-style-type: none"> <li>▪ Bizone kit direct pump</li> <li>▪ Bizone kit mixed pump</li> </ul>
---------	---

## [6.5] Operation modes

**[6.5.1] Disinfection**

⚙️[N/A]	Shows (read-only) the status of the <b>Disinfection</b> function. For more information about this function, see " <a href="#">[4.10] Disinfection / [4.18] Disinfection enable</a> " [▶ 109].
	<ul style="list-style-type: none"> <li>▪ Unsuccessful</li> <li>▪ Successful</li> <li>▪ Maintain</li> <li>▪ Tank heat-up</li> </ul>

**[6.5.2] Defrost/oil return**

⚙️[N/A]	Shows (read-only) the status of the <b>Defrost/oil return</b> function.
	<ul style="list-style-type: none"> <li>▪ Off</li> <li>▪ On</li> </ul>

**[6.5.3] Hot start**

⚙️[N/A]	Shows (read-only) the status of the <b>Hot start</b> function. Hot start means that the heat pump performs a start-up procedure without pump operation of the unit.
	<ul style="list-style-type: none"> <li>▪ Off</li> <li>▪ On</li> </ul>

**[6.5.4] Powerful operation**

⚙️[N/A]	Shows (read-only) the status of the <b>Powerful operation</b> function. For more information, see " <a href="#">6.6.2 Powerful heating mode</a> " [▶ 37].
	<ul style="list-style-type: none"> <li>▪ Off</li> <li>▪ On</li> </ul>

**[6.5.5] Emergency**

⚙️[N/A]	Shows (read-only) the status of the <b>Emergency</b> function. For more information, see " <a href="#">[5.23] Emergency selection</a> " [▶ 132].
	<ul style="list-style-type: none"> <li>▪ Off</li> <li>▪ On</li> </ul>

**[6.5.6] Emergency SH/C**

⚙️[N/A]	Shows (read-only) the status of the emergency space heating function. For more information, see " <a href="#">[5.23] Emergency selection</a> " [▶ 132].
	<ul style="list-style-type: none"> <li>▪ Idle</li> <li>▪ Stop</li> <li>▪ Reduced</li> <li>▪ Normal</li> </ul>

**[6.5.7] Emergency DHW**

⚙️[N/A]	Shows (read-only) the status of the emergency domestic hot water function. For more information, see " <a href="#">[5.23] Emergency selection</a> " [▶ 132].
---------	--

- Idle
- Stop
- Normal

#### [6.5.8] Demand response

⚙️[N/A]	Shows (read-only) the demand response mode of the system. For more information, see " <a href="#">[9.14] Demand response</a> " [▶ 148].
	<ul style="list-style-type: none"> <li>▪ Free</li> <li>▪ Forced off</li> <li>▪ Forced on</li> <li>▪ Recommended on</li> <li>▪ Reduced</li> </ul>

#### [6.5.9] Water pipe freeze prevention

⚙️[N/A]	<p><b>Restriction:</b> Only relevant for installations with water piping outdoors.</p> <p>Shows (read-only) the status of the <b>Water pipe freeze prevention</b> function. For more information, see "<a href="#">[5.36] Water pipe freeze prevention</a>" [▶ 136].</p>
	<ul style="list-style-type: none"> <li>▪ Off</li> <li>▪ On</li> </ul>

#### [6.5.10] Antifrost

⚙️[N/A]	Shows (read-only) the status of the room antifrost function. For more information, see " <a href="#">[3.4] Antifrost</a> " [▶ 101] and " <a href="#">[1.22] Antifrost</a> " [▶ 78].
	<ul style="list-style-type: none"> <li>▪ Off</li> <li>▪ On</li> </ul>

#### [6.5.11] Power limit status

⚙️[N/A]	Shows (read-only) the power limit status of the system. For more information, see " <a href="#">[9.14] Demand response</a> " [▶ 148].
	<ul style="list-style-type: none"> <li>▪ Forced off</li> <li>▪ Limit active</li> <li>▪ Limit overruled</li> <li>▪ Limit enabled</li> <li>▪ None</li> </ul>

#### [6.5.12] Tank preheating

⚙️[N/A]	Shows (read-only) the status of the tank preheating mode. If the system fails to defrost during space heating operation, the electrical backup heater steps in to heat up the tank until the needed capacity is available to do the defrosting.
	<ul style="list-style-type: none"> <li>▪ Off</li> <li>▪ On</li> </ul>

**[6.5.13] Tank support**

⚙️[N/A]	<p><b>Restriction:</b> Only applicable for ECH<sub>2</sub>O units.</p> <p>Shows (read-only) the status of the <b>Tank support</b> function. For more information, see "<a href="#">[5.21] Intelligent tank management</a>" [▶ 126].</p>
	<ul style="list-style-type: none"> <li>▪ Not allowed</li> <li>▪ Allowed (tank boiler)</li> <li>▪ Allowed (free energy)</li> </ul>

**[6.6] About**

⚙️[N/A]	Shows (read-only) information (model names, serial numbers, software versions, ...) about the system.
---------	---

**[6.7] Indoor unit model name / [6.8] Indoor unit serial number**

⚙️[N/A]	<p><b>Restriction:</b> These settings are only visible to certified installers (Stand By Me – Certified Partner) when the model name and serial number fields are still empty in the EEPROM.</p> <p>After replacing the interface PCB, the model name and serial number may not always be automatically saved in the hydro software. Check if settings [6.7] and [6.8] are visible.</p> <ul style="list-style-type: none"> <li>▪ If not visible, the model name and serial number were automatically saved.</li> <li>▪ If visible, the model name and serial number were NOT automatically saved. You need to fill in settings [6.7] and [6.8].</li> </ul> <p><b>Important:</b></p> <ul style="list-style-type: none"> <li>▪ Ensure this information is accurately filled in for the correct functioning of the unit.</li> <li>▪ <b>Double-check the entries, as incorrect input cannot be corrected and will result in the unit not working.</b></li> </ul>
	<p><b>[6.7] Indoor unit model name</b></p> <ul style="list-style-type: none"> <li>▪ Enter model name (unit identification label)</li> <li>▪ Confirm with the ✓ button.</li> </ul>
	<p><b>[6.8] Indoor unit serial number</b></p> <ul style="list-style-type: none"> <li>▪ Enter serial number (unit identification label)</li> <li>▪ Confirm with the ✓ button.</li> </ul>

## [7] Maintenance mode

See the commissioning chapter in the installation manual of the indoor unit or the installer reference guide.



### NOTICE

**Maintenance mode.** During maintenance mode the following operations are ignored / NOT ignored:

- **NOT ignored:** [9.15.4] Outdoor unit fuse limit.

- **Ignored:**

- [9.15.1] Legal limit
- [9.15.3] System limit
- [9.14.1] = Smart Grid ready contacts (or via Modbus / Cloud) (Smart Grid operation modes: Forced off / Forced on / Recommended on)
- [9.14.1] = Smart Meter Contact (or via Modbus / Cloud) (imposed power limit)
- [5.2] Quiet operation



### INFORMATION

#### Remote firmware update

1. If  is displayed on the home screen, remote firmware update download is ongoing, and **Maintenance mode** cannot be started (greyed out) nor can the **Refrigerant recovery mode** be entered.

- **Note:** Downloading can take up to 60 minutes. During downloading, normal operation will continue.

- **Note:** If the firmware download is unsuccessful or interrupted, you must manually restart the process. The system does not perform automatic retries.

- Once downloading is finished, the unit gently shuts down its operation to reboot the system and will restart afterwards (if required).

2. During **Maintenance mode**, the remote firmware update cannot be started.

3. During **Refrigerant recovery mode**, the remote firmware update cannot be started.

## [8] Connectivity

In this chapter

[8.1] TCP/IP configuration .....	143
[8.2] Connection status .....	143
[8.3] Wireless gateway .....	143
[8.4] Connection details .....	144
[8.5] Daikin Home Controls .....	144
[8.6] Safe removal USB drive .....	144
[8.7] Modbus TCP/IP (502) .....	145
[8.8] Modbus TCP/IP TLS (802) .....	145
[8.9] Remove from cloud .....	145
[8.10] Connect to ONECTA cloud .....	145
[8.11] Cloud connection type .....	145

### [8.1] TCP/IP configuration

⚙️[N/A]	<p>Defines the IP settings.</p> <p>Changes to the IP settings are saved only when the confirm button is pressed. Therefore, when pressing the back or home button, the changes are discarded.</p>
	<ul style="list-style-type: none"> <li>▪ DHCP (ON/OFF)</li> </ul> <p>If DHCP = OFF, you can define the following:</p> <ul style="list-style-type: none"> <li>▪ TCP/IP address</li> <li>▪ TCP/IP subnet mask</li> <li>▪ TCP/IP default gateway</li> <li>▪ TCP/IP DNS1</li> <li>▪ TCP/IP DNS2</li> </ul>

### [8.2] Connection status

⚙️[N/A]	<p>Shows (read-only) the connection status of the different external components.</p>
	<ul style="list-style-type: none"> <li>▪ Hydro</li> <li>▪ Backup heater</li> <li>▪ Touchscreen</li> <li>▪ Outdoor unit</li> <li>▪ Mixing kit</li> <li>▪ Daikin room thermostat (Main zone)</li> <li>▪ Cloud connection</li> <li>▪ Wireless gateway</li> <li>▪ LAN connection</li> <li>▪ Modbus</li> <li>▪ Daikin HomeHub</li> </ul>

### [8.3] Wireless gateway

⚙️[N/A]	<p>Defines the WLAN settings.</p>
	<p>See "9.4 Using WLAN" [▶ 61].</p>

## [8.4] Connection details

⚙️[N/A]	Shows (read-only) an overview of the connection details.
	<ul style="list-style-type: none"> <li>▪ TCP/IP address</li> <li>▪ TCP/IP subnet mask</li> <li>▪ TCP/IP default gateway</li> <li>▪ TCP/IP DNS1</li> <li>▪ TCP/IP DNS2</li> <li>▪ MAC address</li> </ul>

## [8.5] Daikin Home Controls

## [8.5.1] Daikin Home Controls

⚙️[N/A]	Must match your system layout. Enables/disables Daikin Home Controls.
	<ul style="list-style-type: none"> <li>▪ OFF (disabled)</li> <li>▪ ON (enabled)</li> </ul>

## [8.5.2] Dehumidifier installed

⚙️[N/A]	Must match your system layout. Defines whether a dehumidifier is installed.
	<ul style="list-style-type: none"> <li>▪ OFF (not installed)</li> <li>▪ ON (installed)</li> </ul>

## [8.5.3] Dew sensor installed

⚙️[N/A]	Must match your system layout. Defines whether a dew sensor is installed, and which type.
	<ul style="list-style-type: none"> <li>▪ <b>No</b>: Not installed.</li> <li>▪ <b>Normally open</b>: Normally open sensor installed.</li> <li>▪ <b>Normally closed</b>: Normally closed sensor installed.</li> </ul>

## [8.5.4] Humidity limit 1

⚙️[N/A]	Defines the humidity limit when a dew sensor is installed.
	40~80%

## [8.5.5] Humidity limit 2

⚙️[N/A]	Defines the humidity limit when no dew sensor is installed.
	41~80%

## [8.6] Safe removal USB drive

⚙️[N/A]	Enables you to safely unplug a connected USB device.
	Removing the USB drive can take several seconds.
	<ul style="list-style-type: none"> <li>▪ OK</li> </ul>

## [8.7] Modbus TCP/IP (502)

⚙️[N/A]	Enables the communication between the unit and the Modbus client using the 502 port.
<ul style="list-style-type: none"> <li>▪ OFF (disabled)</li> <li>▪ ON (enabled)</li> </ul>	

## [8.8] Modbus TCP/IP TLS (802)

⚙️[N/A]	Enables the communication between the unit and the Modbus client using the TLS encryption protocol and the 802 port.
<ul style="list-style-type: none"> <li>▪ OFF (disabled)</li> <li>▪ ON (enabled)</li> </ul>	

## [8.9] Remove from cloud

⚙️[N/A]	Remove the current connection interface (WLAN/LAN) from the cloud.
In the <b>Remove from cloud</b> screen, choose <b>Confirm</b> to remove the connection interface from the cloud.	

## [8.10] Connect to ONECTA cloud

⚙️[N/A]	Defines which cloud connection interface is used to connect to the ONECTA app.
Choose between <b>Wireless gateway</b> (WLAN) or <b>LAN cable</b> (LAN). For more information, see " <a href="#">9.4 Using WLAN</a> " [▶ 61] and " <a href="#">9.5 Using LAN</a> " [▶ 63].	

## [8.11] Cloud connection type

⚙️[N/A]	Manually sets the cloud connection type, regardless of the currently active connection type.
<ul style="list-style-type: none"> <li>▪ None</li> <li>▪ <b>Wireless gateway</b></li> <li>▪ LAN cable</li> </ul>	

## [9] Energy

In this chapter

[9.1] Electricity price .....	146
[9.2] Electricity price baseline .....	146
[9.3] Electricity price schedule enable .....	146
[9.4] Electricity price schedule .....	147
[9.5] Gas price .....	147
[9.6] NOT USED .....	147
[9.7] NOT USED .....	147
[9.8] NOT USED .....	147
[9.9] Legal disclaimer .....	147
[9.10] NOT USED .....	147
[9.11] Boiler efficiency .....	147
[9.12] PE factor .....	147
[9.13] Energy price considered .....	148
[9.14] Demand response .....	148
[9.15] System limitations .....	154

### [9.1] Electricity price

⚙️[N/A]	<p><b>Restriction:</b> Only applicable if [9.3] <b>Electricity price schedule enable</b> is OFF.</p> <p>When no schedule is set for the electricity price, this price will be taken into account.</p> <p>For more information, see "<a href="#">5.2 To set the fixed electricity price (no scheduling)</a>" [▶ 29].</p>
---------	---



#### INFORMATION

Price value ranging from 0.00~5000 valuta/kWh (with 2 significant values).

### [9.2] Electricity price baseline

⚙️[N/A]	<p><b>Restriction:</b> Only applicable if [9.3] <b>Electricity price schedule enable</b> is ON.</p> <p>When the schedule is ON, the electric price follows a block based schedule. The <b>Electricity price baseline</b> will be used at times when no electricity price is scheduled (i.e. in between the schedule blocks).</p> <p>For more information, see "<a href="#">5.3 To set the scheduled electricity baseline price</a>" [▶ 30].</p>
---------	---



#### INFORMATION

Price value ranging from 0.00~5000 valuta/kWh (with 2 significant values).

### [9.3] Electricity price schedule enable

⚙️[N/A]	<p><b>Restriction:</b> Only applicable when bivalent or tank boiler is present.</p> <p>Enables/disables the electricity price schedule.</p> <p>For more information, see "<a href="#">5.4 To set the electricity price schedule</a>" [▶ 30].</p>
	<ul style="list-style-type: none"> <li>▪ ON (enabled)</li> <li>▪ OFF (disabled)</li> </ul>

## [9.4] Electricity price schedule

⚙️[N/A]	<p><b>Restriction:</b> Only applicable when bivalent or tank boiler is present.</p> <p>You can set a weekly schedule timer for electricity prices.</p> <p>For more information, see "<a href="#">5.4 To set the electricity price schedule</a>" [▶ 30].</p>
---------	---

## [9.5] Gas price

⚙️[N/A]	<p><b>Restriction:</b> Only applicable when bivalent or tank boiler is present.</p> <p>Set the correct gas price. For more information, see "<a href="#">5.5 To set the gas price</a>" [▶ 30].</p>
---------	--

## [9.6] NOT USED

## [9.7] NOT USED

## [9.8] NOT USED

## [9.9] Legal disclaimer

The calculated produced heat and consumed energy are estimations, the accuracy cannot be guaranteed.

## [9.10] NOT USED

## [9.11] Boiler efficiency

⚙️[026]	<p><b>Restriction:</b> Only applicable when bivalent or tank boiler is present.</p> <p><b>Boiler efficiency</b> depends on the used boiler.</p>
<ul style="list-style-type: none"> <li>▪ 0.1~1.0</li> </ul>	

## [9.12] PE factor

⚙️[141]	<p><b>Restriction:</b> Only applicable when bivalent or tank boiler is present.</p> <p><b>PE factor</b> = Primary Energy factor. Compares the primary energy use of the heat pump with that of the boiler.</p>
<ul style="list-style-type: none"> <li>▪ 0~6, step: 0.1 (default: 2.5)</li> </ul> <p>The primary energy factor indicates how many units of primary energy (natural gas, crude oil, or other fossil fuels, prior to undergoing any human-made conversions or transformations) are needed to obtain one unit of a certain (secondary) energy source, such as electricity. The primary energy factor for natural gas is 1. Assuming an average electricity production efficiency (including transportation losses) of 40%, the primary energy factor for electricity equals 2.5 (=1/0.40). The primary energy factor allows you to compare two different energy sources. In this case, the primary energy use of the heat pump is compared to the natural gas use of the gas boiler.</p>	

## [9.13] Energy price considered

⚙️[N/A]	<p><b>Restriction:</b> Only applicable when bivalent or tank boiler is present.</p> <p>If an external heat source is available, the main heat source will be chosen based on a comparison between both efficiencies of the heat sources.</p> <p>The decision on which source to select depends on the setting [9.13] <b>Energy price considered</b>. This setting defines if the energy prices are considered or not.</p> <p>For more information, see "<a href="#">5.1 Energy price considered</a>" [▶ 29] and "<a href="#">5.14 Bivalent settings / Tank boiler settings</a>" [▶ 122].</p>
	<ul style="list-style-type: none"> <li>▪ ON (enabled)</li> <li>▪ OFF (disabled)</li> </ul>

## [9.14] Demand response



**NOTICE**

**Imposed power limit.** You can define a maximum limit to the power consumption of the heat pump and the electrical heat sources in different ways.

**1. Via hardware contact:**

- Install a Smart Grid meter.
- Set [9.14.1] = **Smart Meter Contact**.
- Define the imposed power limit in [9.14.7] **Smart meter limit**.

**2. Via Modbus:**

- Use holding register 58: Imposed power limit.

**3. Via Cloud:** Momentarily, only available for business-to-business integrators. For more information, see <https://developer.cloud.daikineurope.com>.

- Use the ONECTA cloud API to define the imposed power limit.

**Note:**

- The imposed power limit can be ignored when the unit runs protective functions (defrost, water pipe freeze prevention, start-up control, maintenance mode).
- If the power limit is too strict to allow start-up or defrost operation, the heat pump will not operate.
- If the power limit is not too strict to allow start-up or defrost operation, the heat pump will operate. However, if the limit is exceeded for too long during operation modes other than start-up or defrost, the unit will stop operating.
- If the backup heater needs to support for protective reasons, the backup heater will kick in with at least a capacity of 2 kW (to ensure reliable operation) even if the power limit would be exceeded.

**NOTICE**

**Smart Grid operation mode.** You can define the Smart Grid operation mode in different ways:

**1. Via hardware:**

- Install 2 incoming Smart Grid contacts.
- Set [9.14.1] = **Smart Grid ready contacts**.
- In the selection box **Connection type**, select **Hardware**.
- Use the 2 incoming Smart Grid contacts to define the mode.

**2. Via Modbus:**

- Set [9.14.1] = **Smart Grid ready contacts**.
- In the selection box **Connection type**, select **External**.
- Use holding register 56: Smart Grid operation mode.

**3. Via Cloud:** Momentarily, only available for business-to-business integrators. For more information, see <https://developer.cloud.daikineurope.com>.

- Set [9.14.1] = **Smart Grid ready contacts**.
- In the selection box **Connection type**, select **External**.
- Use the ONECTA cloud API to adjust the Smart Grid operation mode.

**[9.14.1] Operation mode**

⚙️[040]	Must match your system layout. Demand response mode setting.
0: None	The outdoor unit is connected to a normal power supply without external demands.
1: Heat pump tariff	<p>The outdoor unit is connected to a preferential kWh rate power supply.</p> <ul style="list-style-type: none"> <li>▪ When the preferential kWh rate signal is sent by the electricity company, the contact will open or close (depending on the <b>Invert</b> selection, which defines whether the logic of the component has to be inverted, in [13] <b>Field IO</b>) and the unit will go in forced OFF mode.</li> </ul> <p>Via settings [9.14.2] and [9.14.3] it is possible that other heat sources take over when enabled.</p> <ul style="list-style-type: none"> <li>▪ When the signal is released again, the voltage-free contact will open or close and the unit will restart operation.</li> </ul> <p><b>Note:</b> The <b>Heat pump tariff</b> is a <b>Field IO</b> connection:</p> <ul style="list-style-type: none"> <li>▪ [13] <b>Field IO (HP Tariff Contact)</b></li> </ul>

<p><b>2: Smart Grid ready contacts</b> (Smart Grid contacts)</p>	<p>A Smart Grid is connected to the system. See below table for the modes activated by the 2 incoming Smart Grid contacts.</p> <p>You also need to select the source of the Smart Grid contacts in the selection box <b>Connection type</b>, which appears when you select <b>Smart Grid ready contacts</b> (or alternatively via field code <b>☙[179]</b>):</p> <ul style="list-style-type: none"> <li>▪ <b>0: Hardware:</b> For Smart Grid contacts connected directly to the unit.</li> <li>▪ <b>1: External:</b> For Cloud and Modbus.</li> </ul> <p><b>Note:</b> The Smart Grid contacts are <b>Field IO</b> connections:</p> <ul style="list-style-type: none"> <li>▪ [13] <b>Field IO (HV/LV Smart Grid Contact 1)</b></li> <li>▪ [13] <b>Field IO (HV/LV Smart Grid Contact 2)</b></li> </ul>
<p><b>3: Smart Meter Contact</b> (Smart Grid meter)</p>	<p>A Smart Grid that allows a power limitation is connected to the system. You can set the power limitation in [9.14.7] <b>Smart meter limit</b>.</p> <ul style="list-style-type: none"> <li>▪ On the system overview screen (see "<a href="#">2.2 Energy flow – System overview screen</a>" [▶ 10]), the demand response mode will be shown as <b>Reduced</b>.</li> <li>▪ The incoming Smart Grid contact activates the power limitation that reduces the power to the heat pump and the electrical heaters (which will be allowed if the limit allows it).</li> <li>▪ It is possible that in some cases the power limitation towards the heat pump is ignored for reliability reasons (e.g. heat pump start-up and defrost operation). See [9.14.7] <b>Smart meter limit</b>.</li> </ul> <p><b>Note:</b> The Smart Grid meter is a <b>Field IO</b> connection:</p> <ul style="list-style-type: none"> <li>▪ [13] <b>Field IO (Smart Meter Contact)</b></li> </ul>

**Smart Grid contacts > Modes:**

The 2 incoming Smart Grid contacts can activate the following modes:

<b>1</b>	<b>2</b>	<b>SG ready 1.0 operation mode</b>
0	0	<p><b>Free running</b></p> <p>The Smart Grid function is NOT active.</p>
0	1	<p><b>Forced off</b></p> <ul style="list-style-type: none"> <li>▪ The unit forces OFF the compressor and the heaters (backup heater, booster heater).</li> <li>▪ Water pipe freeze prevention by the backup heater will still be allowed during the forced off operation.</li> <li>▪ Via settings [9.14.2] and [9.14.3] it is possible that other heat sources take over when enabled.</li> </ul>

1	2	SG ready 1.0 operation mode
1	0	<p><b>Recommended on</b></p> <ul style="list-style-type: none"> <li>In case the space heating/cooling request is OFF and the tank temperature setpoint is reached, the unit can choose to buffer energy from the photovoltaic panels in the room (only in case of room thermostat control) or in the DHW tank instead of putting the photovoltaic panel energy on the grid.</li> <li>In case of room buffering (see [9.14.4]), the room will heat up or cool down to the comfort setpoint. In case of tank buffering, the tank will heat up to the maximum tank temperature.</li> </ul>
1	1	<p><b>Forced on</b></p> <p>Similar to <b>Recommended on</b>, but in this case other electrical heat sources will be activated in parallel to support space heating or tank heat-up without limiting settings as we have in recommended ON ([9.14.5] / [9.14.6]).</p> <p><b>Note:</b> Room buffering will happen independently from setting [9.14.4] <b>Allow buffering space H/C</b>.</p>

1	2	SG ready 1.1 operation mode
0	1	Operating state 1 (for a description, see SG ready 1.0: " <b>Forced off</b> " and " <b>Forced on</b> ")
1	1	
0	0	Operating state 2 (for a description, see SG ready 1.0: " <b>Free running</b> ")
1	0	Operating state 3 (for a description, see SG ready 1.0: " <b>Recommended on</b> ")

**Emergency mode** (see " [5.23] **Emergency selection**" [▶ 132]). In case emergency mode is active, buffering is still allowed, even when emergency mode does NOT allow an automatic take-over by electrical heater for space heating or for DHW operation.



#### INFORMATION

During the **Forced on** mode, the room buffering will happen independently from the **Allow buffering space H/C** [9.14.4] setting. During the **Recommended on** mode, the room buffering will only happen when the room buffering is enabled ([9.14.4] = On).

### [9.14.2] SH heater take-over during forced off

⚙️[037]	<p><b>Restriction:</b> Only applicable if [9.14.1] =</p> <ul style="list-style-type: none"> <li>Heat pump tariff</li> <li>Smart Grid ready contacts</li> </ul> <p>Defines whether another heat source can take over the space heating when the heat pump is not allowed to work because of an active limit or because of a forced OFF command.</p>
	<ul style="list-style-type: none"> <li><b>0: No take-over:</b> No other heat source can take over.</li> <li><b>1: Fossil take over:</b> If there is a bivalent boiler or tank boiler available, the bivalent boiler or tank boiler can take over.</li> <li><b>2: Heater take over:</b> Backup heater can take over.</li> </ul>

[9.14.2]	Booster heater	Backup heater	Bivalent boiler / tank boiler	Compressor
0: No take-over	OFF	OFF	OFF	OFF
1: Fossil take over	OFF	OFF	Take-over	OFF
2: Heater take over	OFF	Take-over	OFF	OFF

### [9.14.3] DHW heater take-over during forced off

⚙️[071]	<p><b>Restriction:</b> Only applicable if [9.14.1] =</p> <ul style="list-style-type: none"> <li>▪ Heat pump tariff</li> <li>▪ Smart Grid ready contacts</li> </ul> <p>Defines whether another heat source can take over the DHW operation when the heat pump is not allowed to work because of an active limit or because of a forced OFF command.</p>
	<ul style="list-style-type: none"> <li>▪ 0: <b>No take-over:</b> No other heat source can take over.</li> <li>▪ 1: <b>Fossil take over:</b> If there is a tank boiler available, the tank boiler can take over.</li> <li>▪ 2: <b>Heater take over:</b> Backup heater and booster heater can take over if available.</li> <li>▪ 3: <b>Only booster heater take-over:</b> Only booster heater can take over if available.</li> </ul>

[9.14.3]	Booster heater	Backup heater	Tank boiler	Compressor
0: No take-over	OFF	OFF	OFF	OFF
1: Fossil take over	OFF	OFF	Take-over	OFF
2: Heater take over	Take-over	Take-over	OFF	OFF
3: Only booster heater take-over	Take-over	OFF	OFF	OFF

**[9.14.4] Allow buffering space H/C**

⚙️[036]	<p><b>Restriction:</b> Only applicable if [9.14.1] = <b>Smart Grid ready contacts</b>.</p> <p>Allows/disallows room buffering during recommended ON mode.</p> <p><b>Note:</b></p> <ul style="list-style-type: none"> <li>▪ During forced on mode, room buffering will always be active.</li> <li>▪ Buffering will be active in room thermostat control. In this case the buffering will happen towards the following setpoints: <ul style="list-style-type: none"> <li>- [1.29] <b>Heating comfort setpoint</b> in heating</li> <li>- [1.30] <b>Cooling comfort setpoint</b> in cooling</li> </ul> </li> </ul>
<ul style="list-style-type: none"> <li>▪ 0: OFF (not allowed): The extra energy from the photovoltaic panels is only buffered in the DHW tank (i.e. heat up the DHW tank).</li> <li>▪ 1: ON (allowed): The extra energy from the photovoltaic panels is buffered in the DHW tank, and in the space heating/cooling circuit (i.e. heat up or cool down the room).</li> </ul>	

**INFORMATION****Tank/room buffering priority:**

- The system starts tank buffering first. When tank buffering is at its maximum capacity, then the system switches to room buffering (if enabled).
- Tank buffering can switch to room buffering prior to reaching the maximal capacity because of internal unit logic. In normal operation, the maximum running time for domestic hot water is applicable.
- When room buffering is ongoing and the tank drops below its maximum capacity (e.g. someone takes a shower), then the system stays at room buffering for a certain amount of time before it switches back to tank buffering.

**[9.14.5] BUH support during SH recommended on**

⚙️[038]	<p><b>Restriction:</b> Only applicable if [9.14.1] = <b>Smart Grid ready contacts</b>.</p> <p>Allows/disallows the backup heater for space heating support in recommended ON mode.</p> <p><b>Note:</b> If the water temperature is too low to allow heat pump operation, and this setting is set to OFF (not allowed), then the electrical heater will NOT push the heat pump into the operation range (because the electrical heater is then not allowed).</p>
<ul style="list-style-type: none"> <li>▪ 0: OFF (not allowed)</li> <li>▪ 1: ON (allowed)</li> </ul>	

**[9.14.6] BUH+BSH support during DHW recommended on**

⚙️[039]	<p><b>Restriction:</b> Only applicable if [9.14.1] = <b>Smart Grid ready contacts</b>.</p> <p>Allows/disallows the backup heater or booster heater for tank heat-up support in recommended ON mode.</p> <p><b>Note:</b> If the tank temperature is too low to allow heat pump operation, and this setting is set to OFF (not allowed), then the electrical heater will NOT push the heat pump into the operation range (because the electrical heaters are then not allowed).</p>
---------	---

- 0: OFF (not allowed)
- 1: ON (allowed)

**[9.14.7] Smart meter limit**

⚙️[135]	<p><b>Restriction:</b> Only applicable if [9.14.1] = <b>Smart Meter Contact</b>.</p> <p>Defines the applicable power limit in case of a Smart Grid meter.</p> <p><b>Note:</b> If the Smart Grid meter limit is active, the heat pump and the additional electrical heat sources are allowed to operate if the limit allows it. However:</p> <ul style="list-style-type: none"> <li>▪ It is possible that in some cases this limit towards the heat pump will be ignored for reliability reasons (e.g. heat pump start-up and defrost).</li> <li>▪ If the backup heater needs to support for protective reasons, the backup heater will kick in with at least a capacity of 2 kW (to ensure reliable operation) even if the power limit would be exceeded.</li> </ul>
2~20 kW step: 0.1 kW	

**[9.15] System limitations**

You can define the following forced system limits:

Forced system limit		Description
[9.15.1] and [9.15.2]	<b>Legal limit</b> (e.g. BBR in Sweden)	Power consumption limit for the complete heat pump installation (value in kW).
[9.15.3]	<b>System limit</b>	
[9.15.4]	<b>Outdoor unit fuse limit</b>	Current consumption limit for the outdoor unit only (value in A).

These limits are static. They are not determined by an external connection, but are fixed values set in the user interface.

These maximum power (kW) or current (A) consumption limits are forced on the heat pump installation. All heat sources follow these maximum limits. If the limit cannot be followed, all operation is stopped. A restart is only allowed when the system can follow the limit again. Optionally, it might be possible to allow other heat sources such as backup heater, booster heater or fossil fuels (e.g. gas). If the option is available, it can be set in the user interface.



**NOTICE**  
**Forced system limits.** During maintenance mode:

- **Legal limit** and **System limit** are ignored.
- **Outdoor unit fuse limit** is NOT ignored.

**[9.15.1] Enable legal limit**

⚙️[N/A]	<p><b>Restriction:</b> Only available if [5.9] <b>Location and language</b> &gt; <b>Country</b> = Sweden.</p> <p>Use this setting in combination with [9.15.2] <b>Legal limit</b>. Enables/disables the legal limit (e.g. BBR in Sweden).</p> <p>If enabled, a 14-day timer starts. When the timer completes, this setting and setting [9.15.2] <b>Legal limit</b> become locked (greyed out). This setting can no longer be changed. If this setting is changed during the 14-day period, the timer resets.</p>
	<ul style="list-style-type: none"> <li>▪ OFF (disabled)</li> <li>▪ ON (enabled)</li> </ul>

**[9.15.2] Legal limit**

⚙️[190]	<p><b>Restriction:</b> Only available if [5.9] <b>Location and language</b> &gt; <b>Country</b> = Sweden.</p> <p>Use this setting in combination with [9.15.1] <b>Enable legal limit</b>. Defines the legal limit (kW) (e.g. BBR in Sweden).</p>
	Value in kW. The minimum possible value depends on the heat pump type.

**NOTICE**

**Legal limit** and **System limit** in case of EPSK12+14A\*:

When a setpoint higher than 65°C is selected with a minimum power limitation of 9 kW, there might be no operation when ⚙️ [037] is selected as no take-over. As in this case, the heat pump might not be able to reach the target temperature. Other heat sources are not allowed to take over the space heating.

**[9.15.3] System limit**

⚙️[189]	Defines the general system limit (kW).
	Value in kW. The minimum possible value depends on the heat pump type.

**NOTICE**

**Legal limit** and **System limit** in case of EPSK12+14A\*:

When a setpoint higher than 65°C is selected with a minimum power limitation of 9 kW, there might be no operation when ⚙️ [037] is selected as no take-over. As in this case, the heat pump might not be able to reach the target temperature. Other heat sources are not allowed to take over the space heating.

**[9.15.4] Outdoor unit fuse limit**

⚙️[191]	<p><b>Restriction:</b> Only available in case of EPSKS04~07A*.</p> <p>Defines the outdoor unit fuse limit (A). This value can be set in steps of 1 A.</p> <p>This limit is only applied to the heat pump (outdoor unit). It is not applied to the indoor unit.</p>
	Value in A. Step: 1 A.

## [10] Configuration wizard

After first power ON of the system, the user interface starts a configuration wizard. Use this wizard to set the most important initial settings for the unit to run properly.

- If needed, you can restart the configuration wizard via the menu structure: [10] Configuration wizard.
- If needed, you can afterwards configure more settings via the menu structure.

### Configuration wizard – Overview

Depending on your unit type and the selected settings, some steps will not be visible.

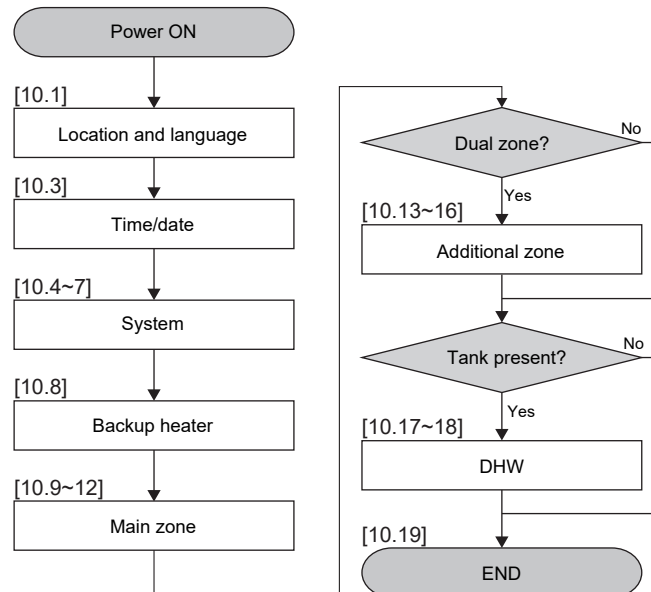

After you completed all steps in the wizard, the user interface will show an error message instructing to enter the Digital Key (i.e. perform the unlocking procedure).

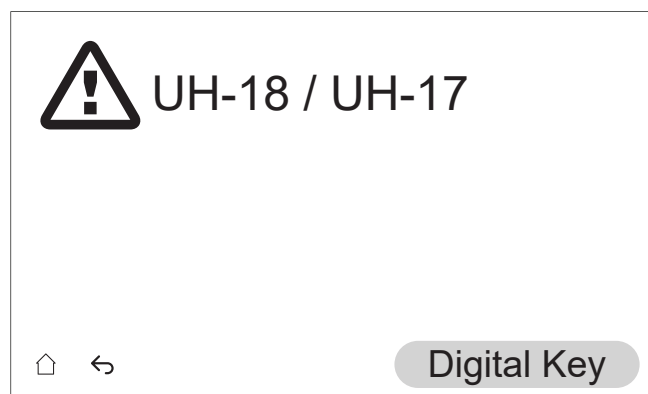

### More information



For more information about the configuration wizard (and how to perform the unlocking procedure), see the installation manual of the indoor unit or the installer reference guide.

## [11] Malfunctioning







See the troubleshooting chapter in the installer reference guide.

To display the help text in case of a malfunction

In case of a malfunction, the following icon will appear on the home screen depending on the severity:

- : Error
- : Warning
- : Information

You can get a short and a long description of the malfunction as follows:

<b>1</b>	<p>Go to [11] <b>Malfunctioning</b>.</p> <p><b>Result:</b> The ongoing malfunctions are shown with the following information:</p> <ul style="list-style-type: none"> <li>▪ The <b>Level</b> icon:             <ul style="list-style-type: none"> <li>- : <b>Error</b></li> <li>- : <b>Warning</b></li> <li>- : <b>Information</b></li> </ul> </li> <li>▪ The error code</li> <li>▪ The <b>Type</b> icon:             <ul style="list-style-type: none"> <li>- : <b>Safety</b>: these are critical errors that can result in an unsafe situation (e.g. refrigerant leak).</li> <li>- : <b>Protection</b>: these are errors related to the protection of the user or the system (eg overheating/disinfection/undercooling).</li> <li>- : <b>Technical</b>: these are all other errors indicating a technical problem of the unit or peripherals (e.g. sensor abnormality).</li> </ul> </li> </ul>
<b>2</b>	<p>Tap on the error message in the error screen.</p> <p><b>Result:</b> A long description of the error is displayed on the screen.</p> <p><b>Note:</b> If the description is too long, use the up/down arrows on the right-hand side of the text box to scroll through the entire text.</p>

[12] NOT USED

## [13] Field IO

When connecting the electrical wiring, for certain components, you can choose which terminal pins to use. After connection, you must tell the user interface which terminal pins you used so that it matches your system layout:

- Preferably, via the breadcrumbs in [13] **Field IO**.
- Alternatively, via the field codes (see the field settings table in the installer reference guide).

For more information about **Field IO** connections, see the installation manual of the indoor unit or the installer reference guide.

