

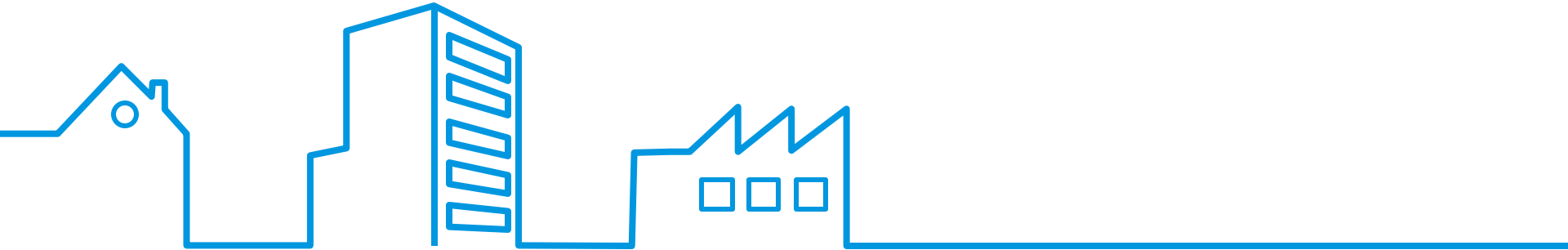

Madoka BRC1H519*

Bedrade afstandsbediening





1. Functionaliteiten

2. Afmetingen

3. Prijs

BRC1H519*:

Overzicht; **Basis** / Service / Onderhoud / Geavanceerd



Compactheid

Compact design,
slechts 85 x 85 mm

EU Design

Winnaar van
verschillende EU
design awards



reddot design award
winner

Intuïtief touchscreen

Volledige bediening
met 3 touch
knoppen:

- / 0 / +



3 verschillende uitvoeringen

Beschikbaar in metallic
zilver, glanzend wit of mat
zwart

Eenvoudig interface

Eenvoudige selectie adhv
pictogrammen

Bedienings App

Madoka Assistant
App - Bluetooth
afstandsbedienings-
connectie



BRC1H519*:

Overzicht; Basis / Service / Onderhoud / Geavanceerd



Snelle inbedrijfstelling

Snellere inbedrijfstelling
ivm de BRC1E53A dankzij
Bluetooth connectie

Uitlezen errorcodes

Mogelijkheid tot
uitlezen errorcodes

Instellingen

Eenvoudig aanpassen
van instellingen zoals
groepsadressen etc.



Installatiemodus

Eenvoudige toegang tot
installatiemodus in de
Madoka Assistant App
Instellingen => info => 5x "Version" klikken

Onderhoudsinformatie

Toegang tot
onderhoudsinformatie

Bedienings App

Madoka Assistant
App - Bluetooth
afstandsbedienings-
connectie



BRC1H519*:

Afmetingen: Verschillend ivm BRC1E51A

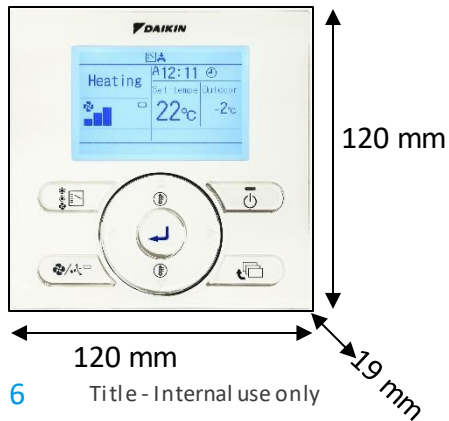
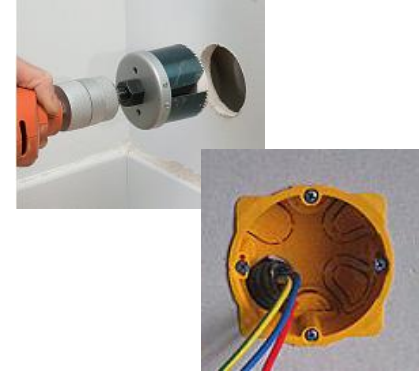
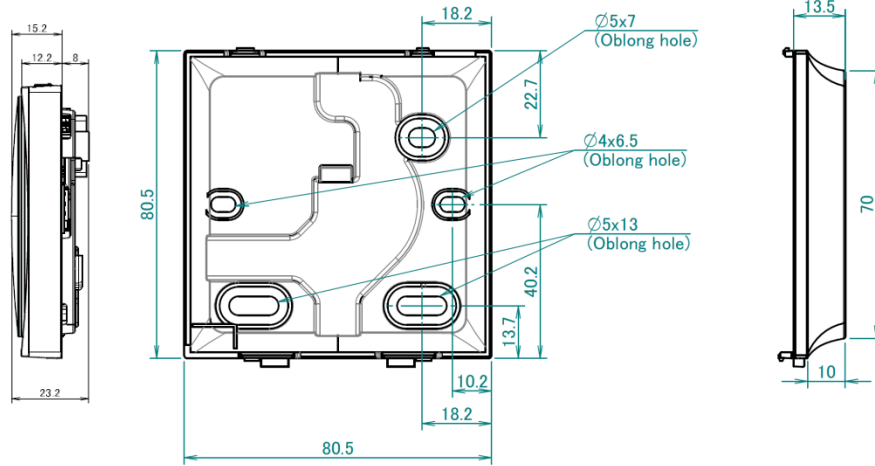

Achteraan

Links

Bovenaan

Onderaan

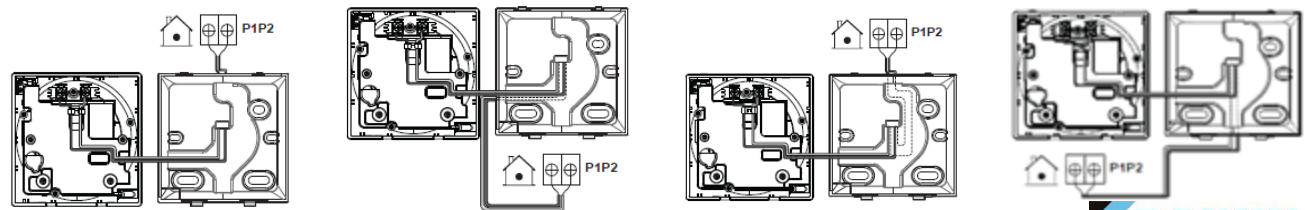



Stap 1: Download “Madoka Assistant en activeer Bluetooth.



Stap 2: Selecteer afstandsbediening tussen apparaten.

Stap 3: Klik “Koppeling uitvoeren” op gsm &

Klik “Bevestigen” op de afstandsbediening.

Stap 4: Connectie gemaakt.

Stap 5: Open Madoka Assistant

Stap 1



Stap 2



Stap 3

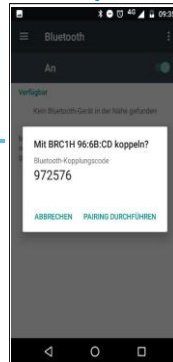

Stap 4

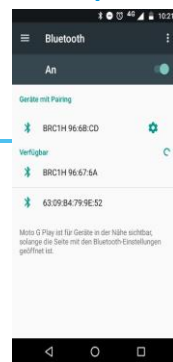

Stap 5

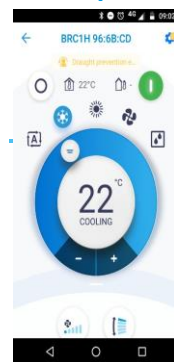

start

15 sec

- Max 10 afstandsbedieningen opslaan in de app
- Bediening via Madoka Assistant
- Instellingen via Madoka Assistant

The user interface is symbol driven (no text).
The basic userinterface functions are:

- On/off
- Operation mode change-over:
 - Cooling / Heating or auto C/H change-over mode or fan only or dry mode
 - (auto C/H change-over mode: cooling and heating adjustable temperature settings)
- Temperature adjustment (°C) during ON/OFF operation
- Airflow level (Fan speed) adjustment
- Airflow direction (Louvre/swing) adjustment
- Filter sign and reset
- Warnings and Errors

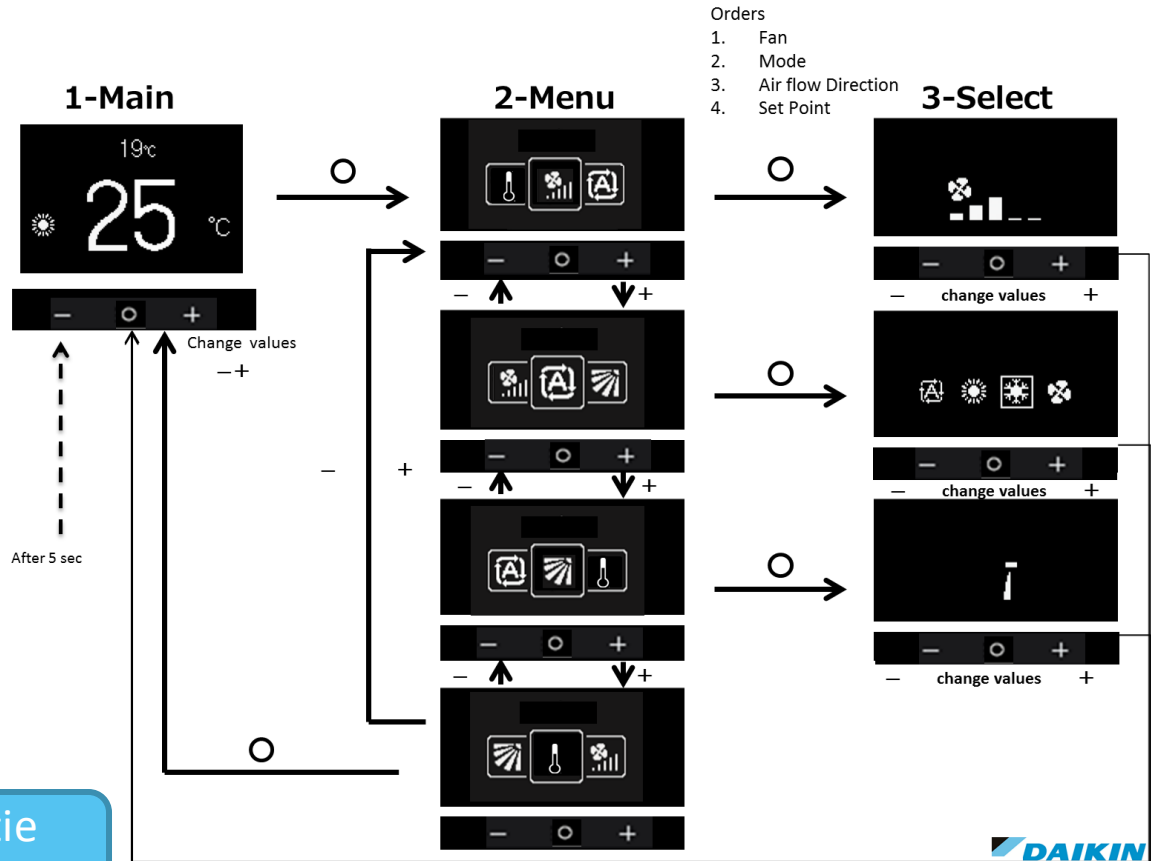

Meer geavanceerde informatie beschikbaar op de Business Portal

Thank you